

6047/3x12



D110216



DIN EN 131



Traversenmontage (als Ersatzteil)

Attaching stabiliser bar

Montage du stabilisateur

0052961
0052958

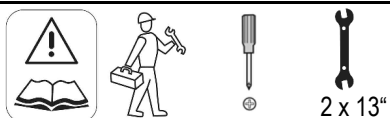

Pos	Stk.	Benennung	0052961	0052958
1	1	Traverse gebogen	0053540	0053541
2	2	Traversenaufnahme 60	0077338	0077338
3	2	Traversenaufnahme 66	0077340	0077340
4	2	Traversenaufnahme 71	0077342	0077342
5	2	Schraube M 8 x 70	006304	006304
6	2	Schraube M 8 x 75	006311	006311
7	2	Schraube M 8 x 80	006301	006301
8	2	Mutter M 8	006716	006716
9	1	Montageanleitung	0095721	0095721

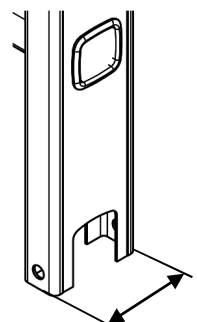

60 mm = Holm 60
66 mm = Holm 66
71 mm = Holm 71

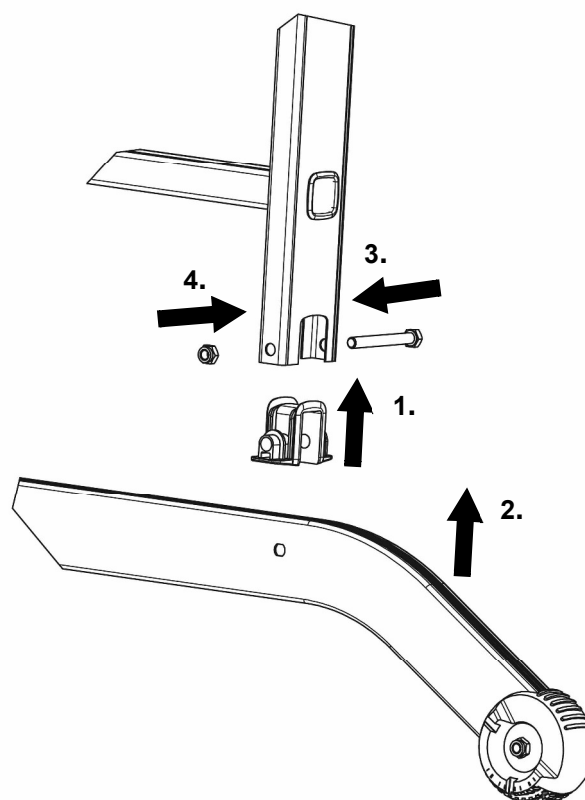
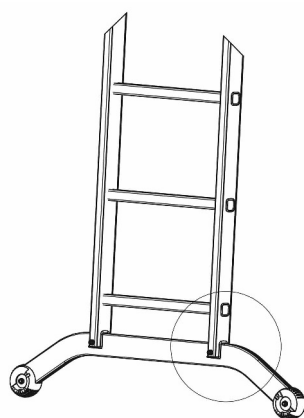
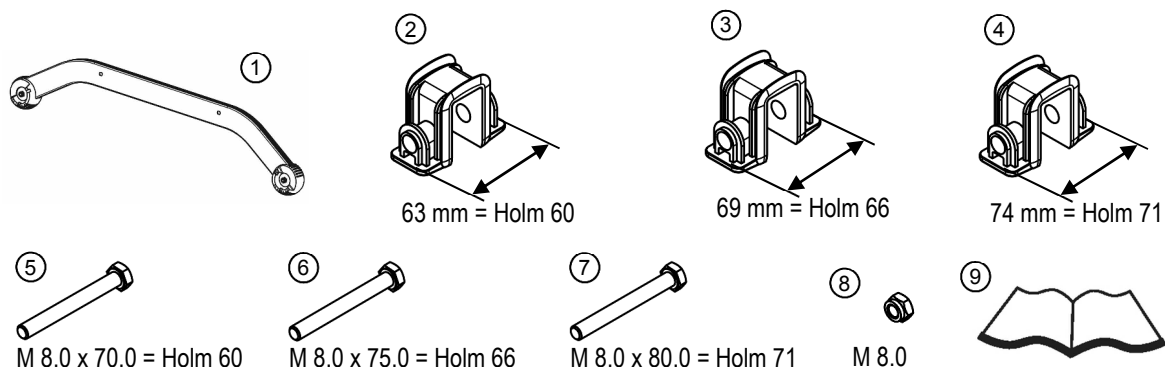

0052961 → 6045 12/16/20/24
0052958 → 6047 18/21/24

Traversenmontage

Attaching stabiliser bar
montage du stabilisateur

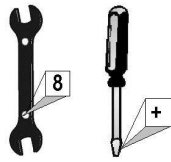

77647 / SC40

SC60

SC80

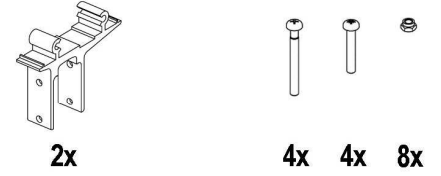
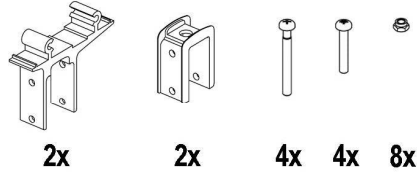
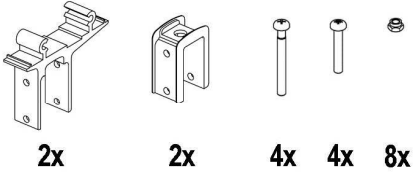

77647 / SC40
SC60
SC80

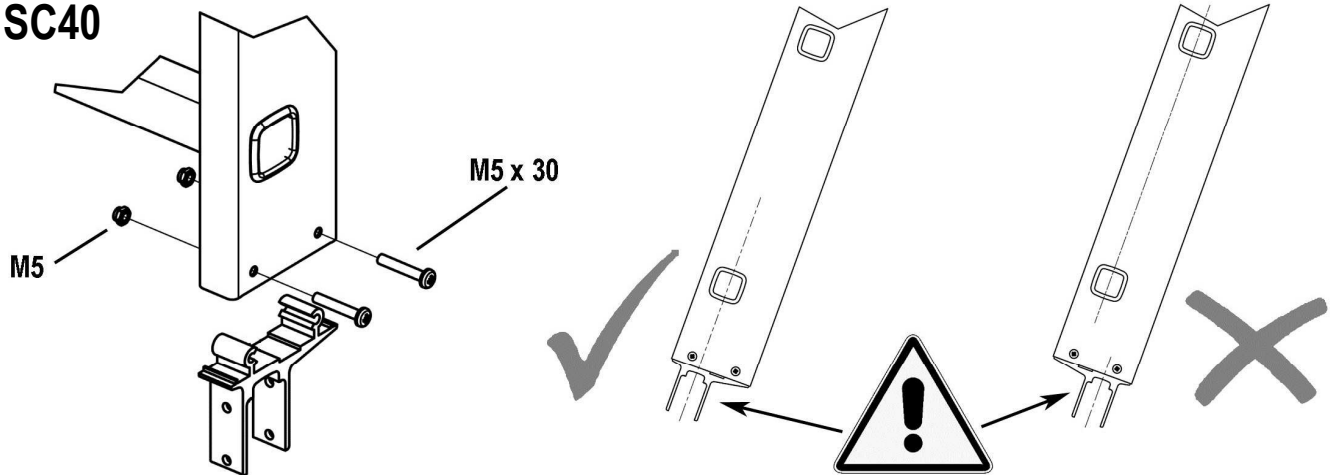

77647 / SC40

SC60

SC80

