

1.

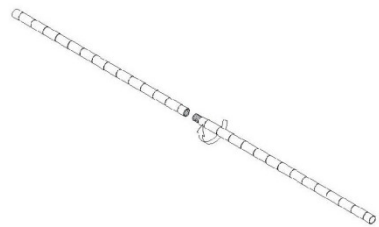

2a.

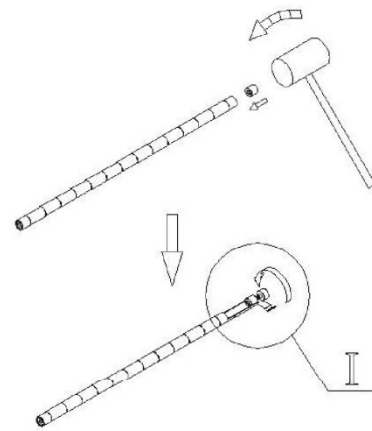

2aI.

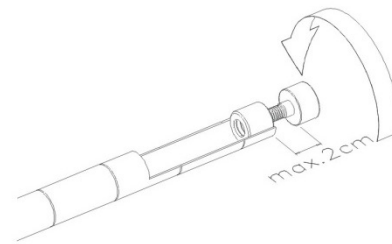

2b.

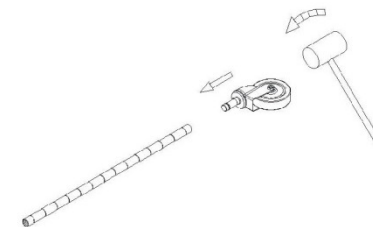

3.

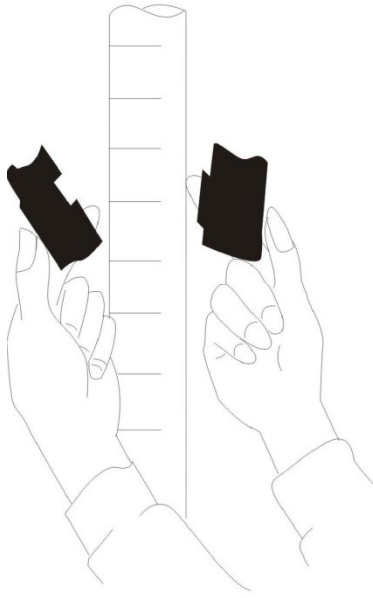

4.

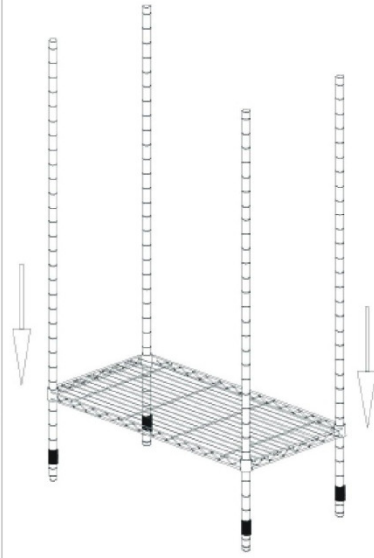

5.

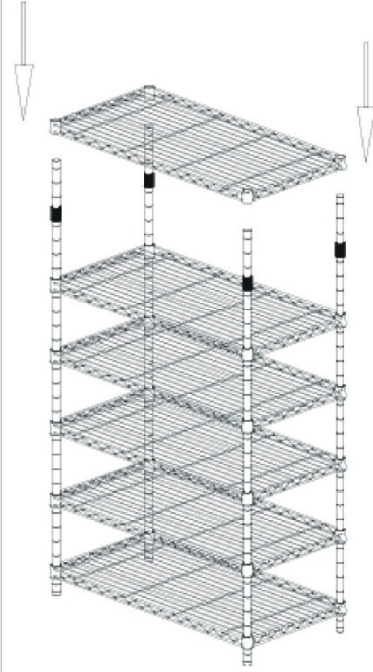

6.

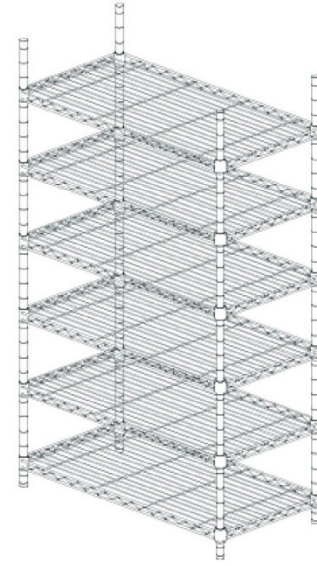

7a.

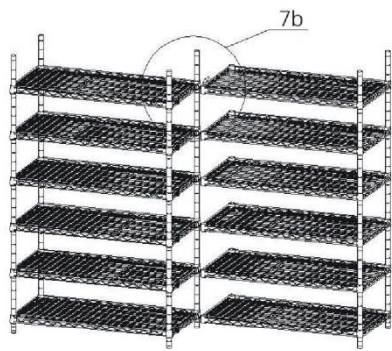

7b.

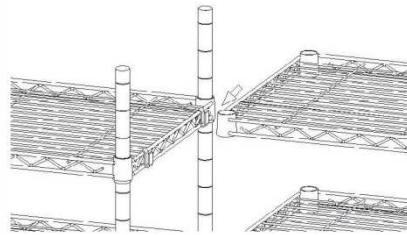

8a.

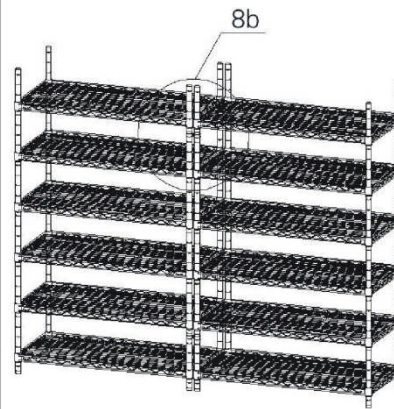

8b.

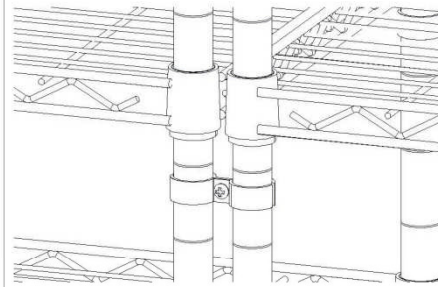

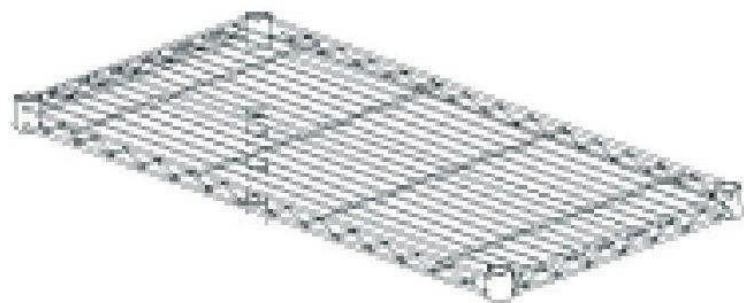

MAX. 150 kg

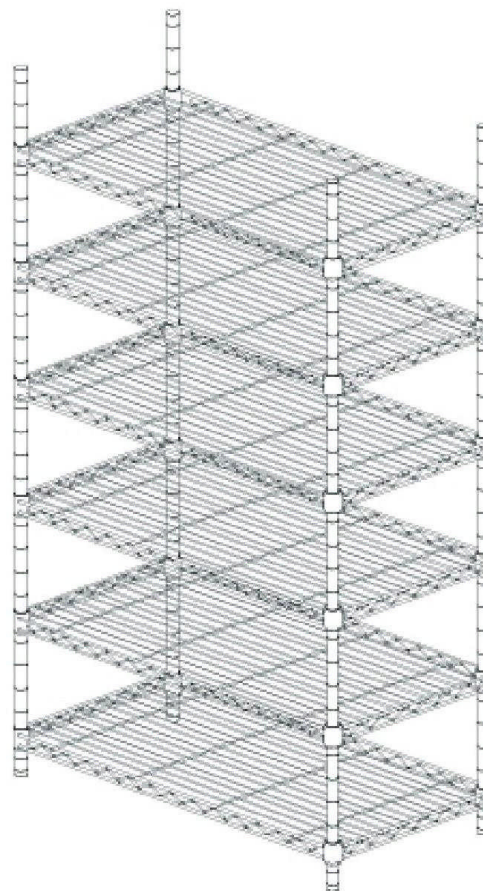

MAX. 1500 kg



MAX. 75 kg

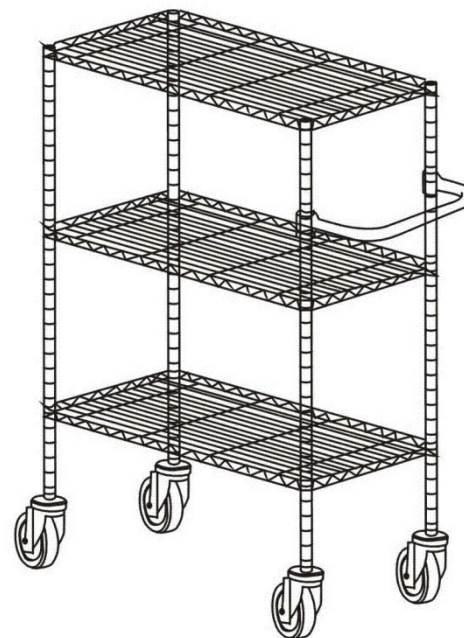

MAX. 300 kg