

Montageanleitung

Mehrzweckhaus Rundecken-Ausführung Typ MR

Optional
mit
Fußboden
Innenverkleidung

Montagebeschreibung

Modulare Raumsysteme



1. Bodenrahmen (Montagerahmen oder optional Fußboden) in Waage legen. (Abb. 1)
2. Dichtungsband 15/2 auf äußeren Rohrahmen kleben. (Abb. 1)
3. Dichtungsband 15/2 auf Längsseiten der Wandelemente kleben. (Abb. 2)
4. Eckpfosten mit Bohrschrauben an Wandelemente schrauben. (Abb. 2)
5. Wandelemente mit Eckpfosten auf äußeren Bodenrahmen/Fußboden setzen und mit Bohrschrauben verschrauben. (Abb. 3)
6. Wandelemente, Türzarge und Eckpfosten aneinander stellen und verbinden. (Abb. 4.0 – 4.2)
7. Dichtungsband 15/2 auf Oberseite der Wandelemente kleben. (Abb. 5.0 – 5.1)
8. Dachrahmen auflegen und mit Wandelement verschrauben. Innenaufstellung (Abb. 5.0) - Aussenaufstellung (Abb. 5.1)
9. Tür montieren. (Abb. 8.0 – 8.1)

Option Innenverkleidung

10. Mineralwolle 40 mm von innen in das Wandelement stellen. (Abb. 6)
11. Spannplatte weiß, 13 mm mit Schrauben 4,5 x 30 mm auf Wandelement schrauben. (Abb. 7)
12. Fußbodenleiste montieren.



Konstruktionsänderungen vorbehalten



Abbildung 1
figure 1



Abbildung 2
figure 2

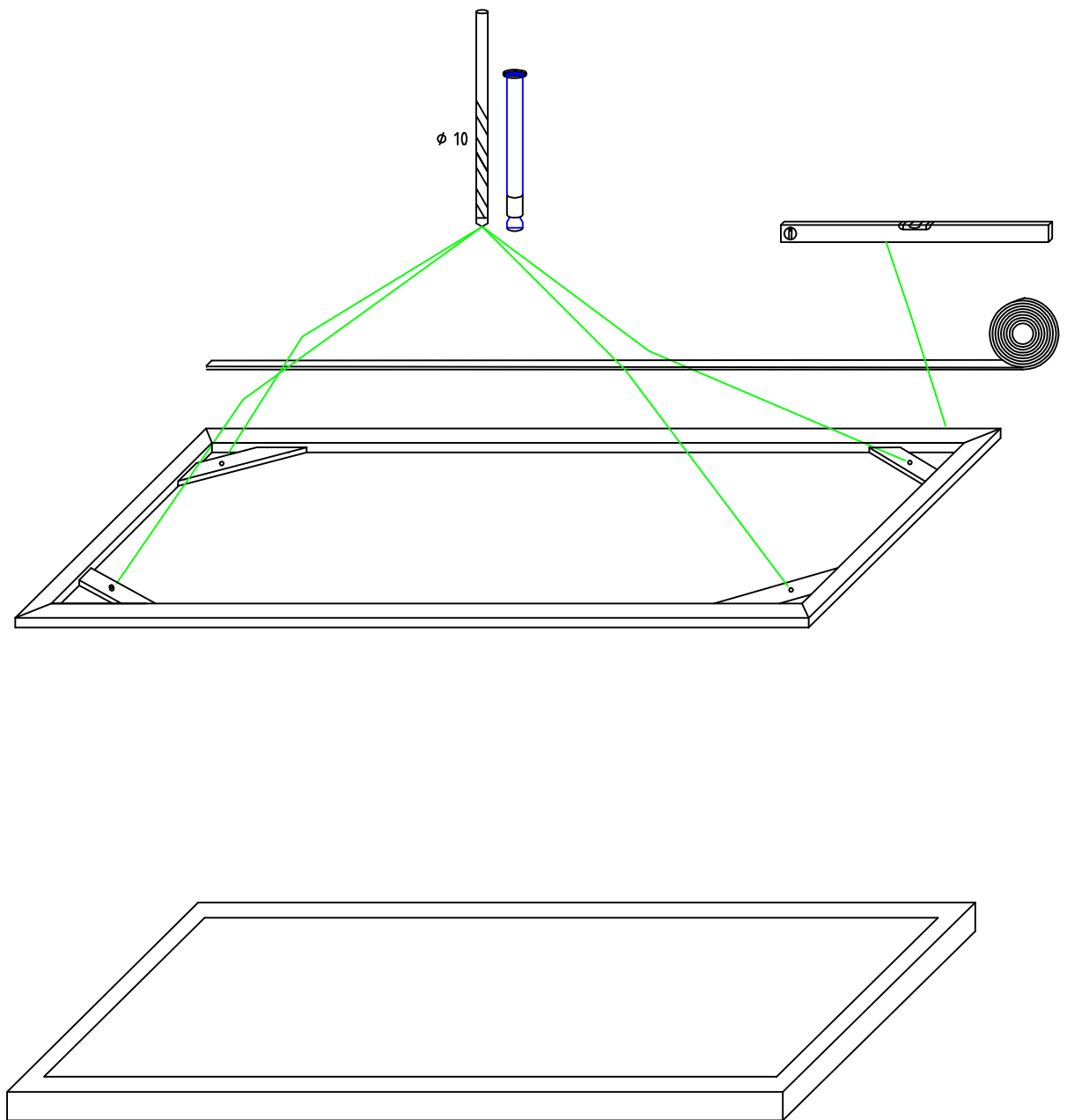

Abbildung 3
figure 3

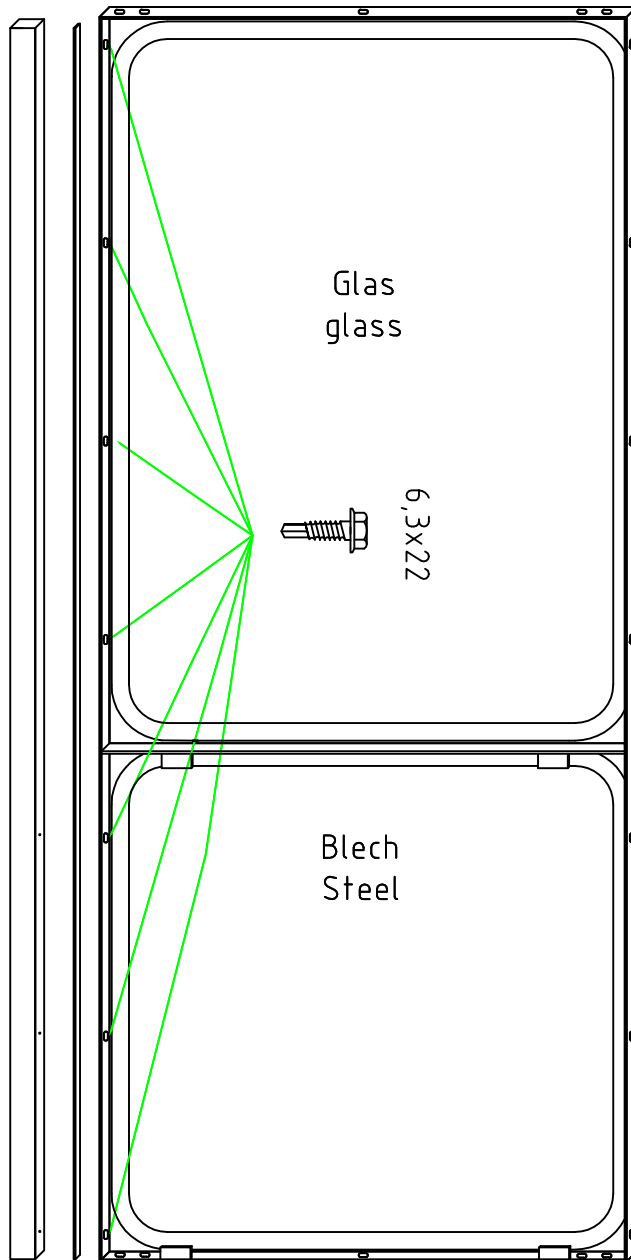

Abbildung 4.0
figure 4.0

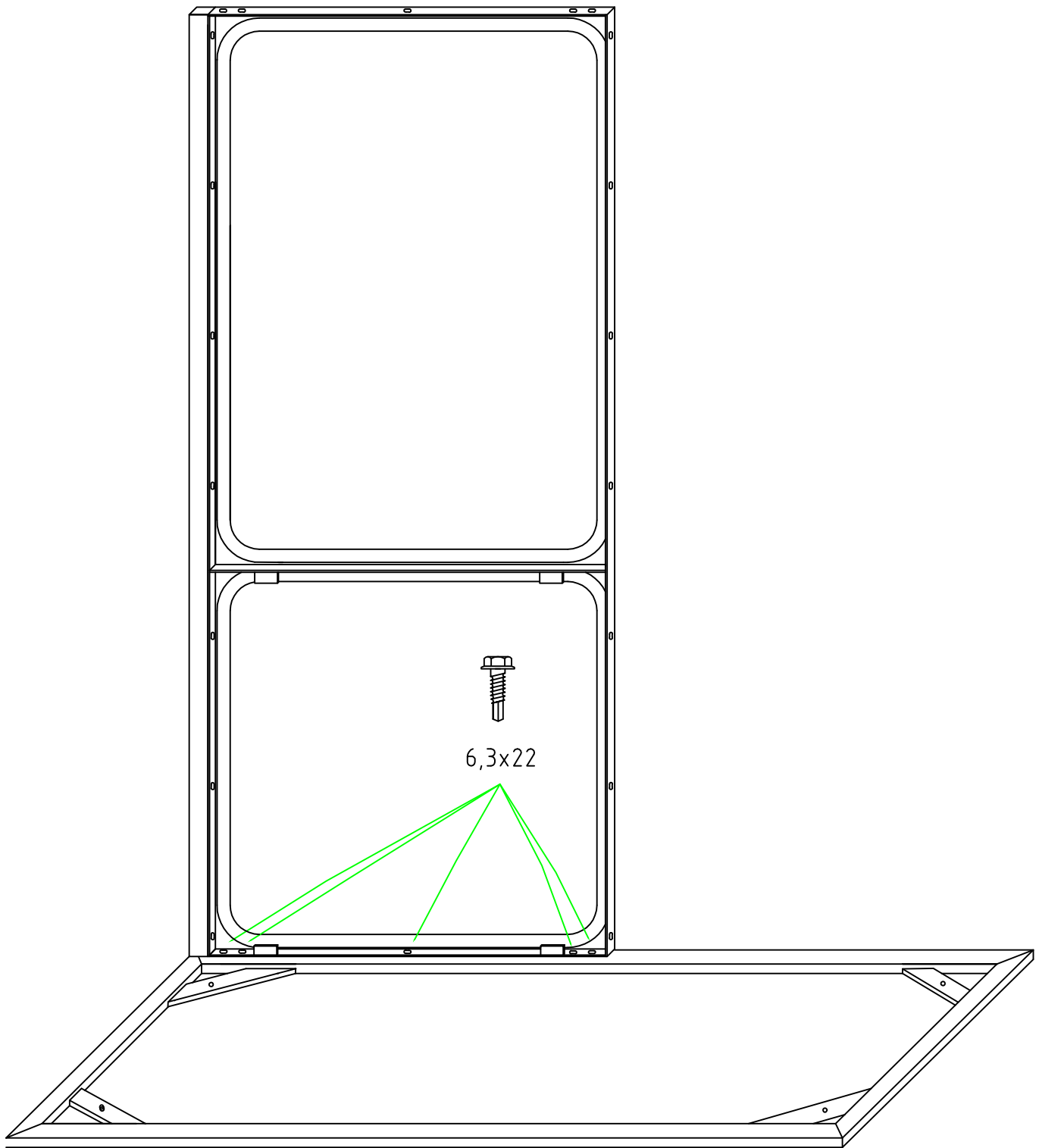

Abbildung 4.1
figure 4.1

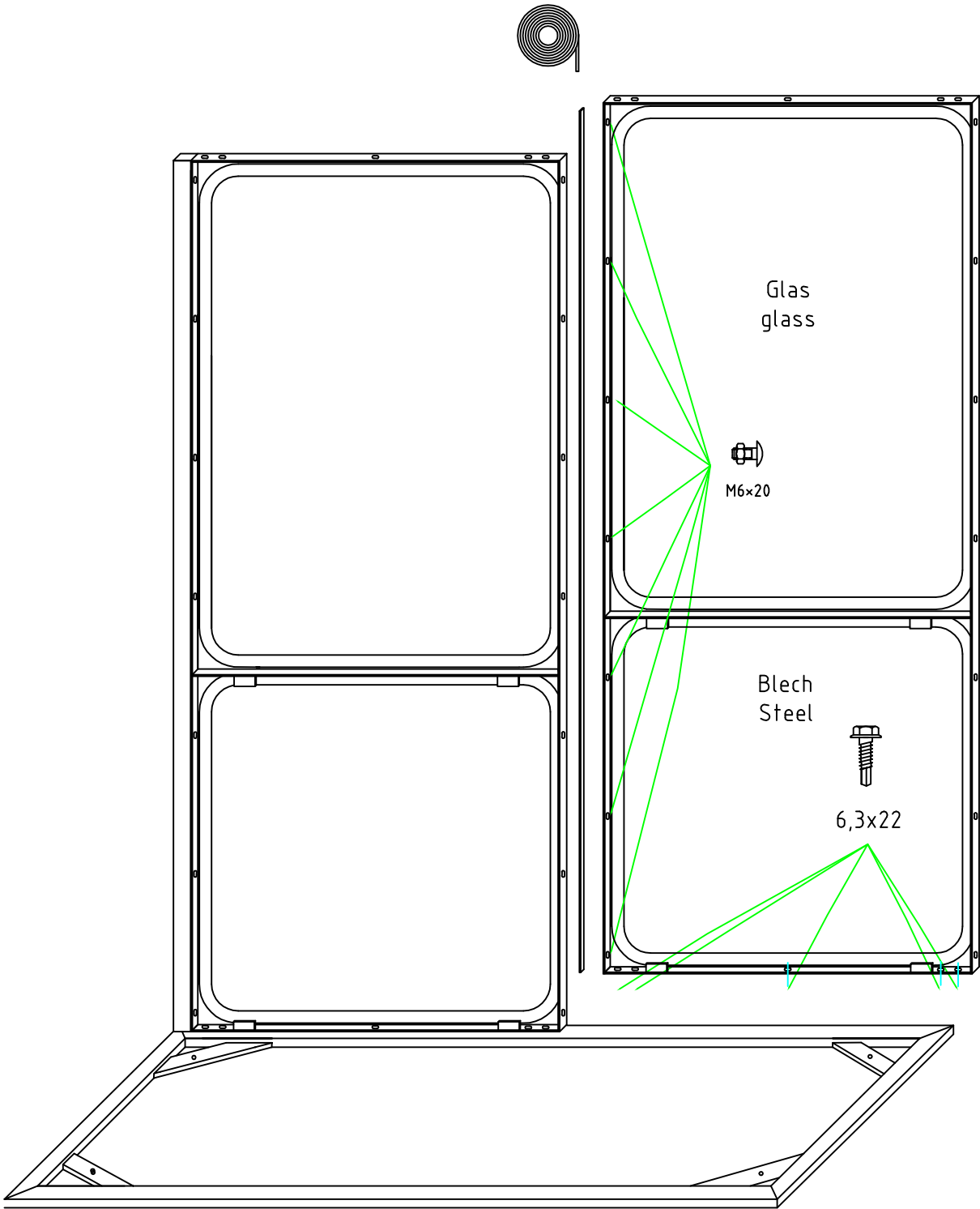

Abbildung 4.2
figure 4.2

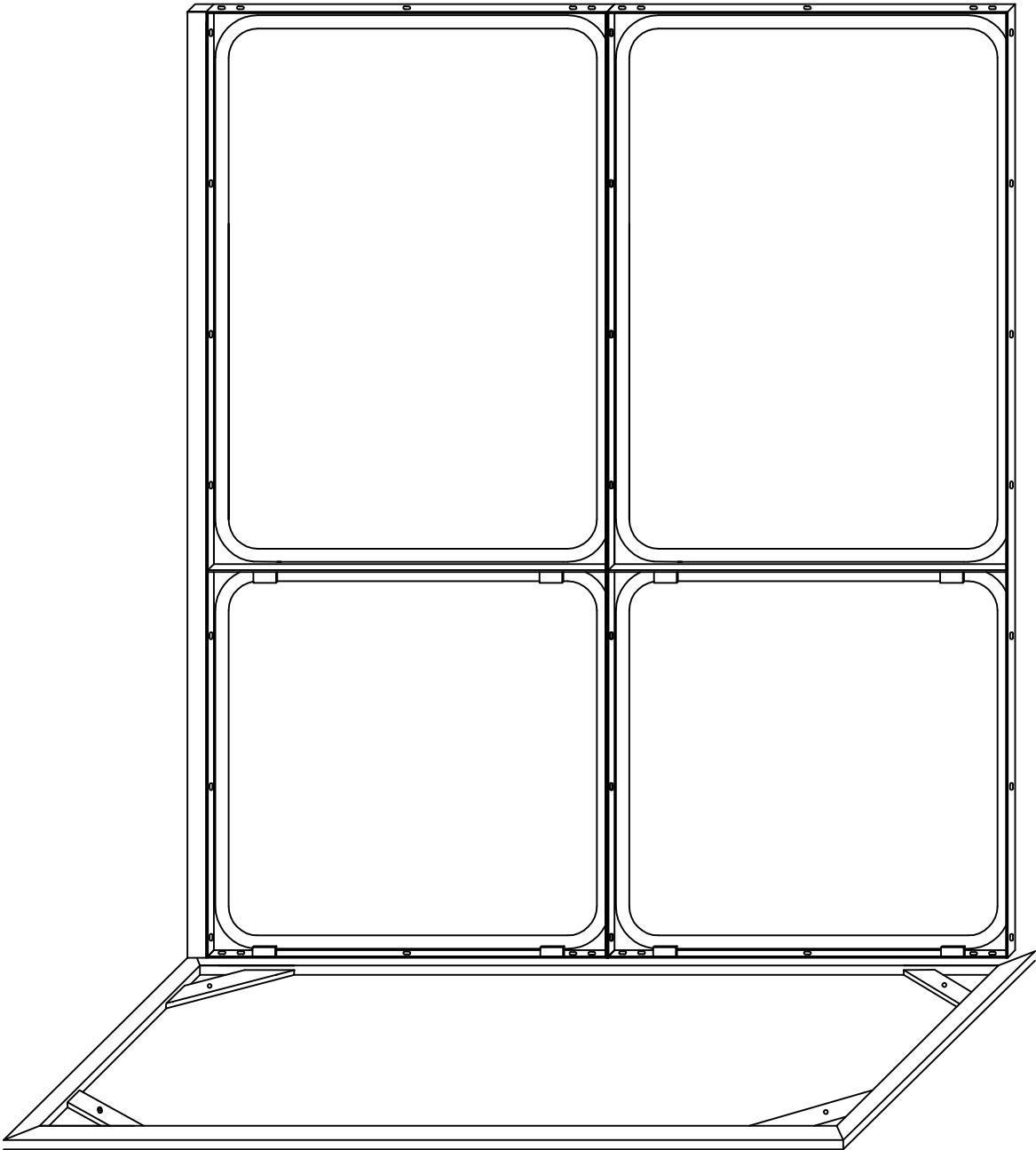

Abbildung 5.0
figure 5.0

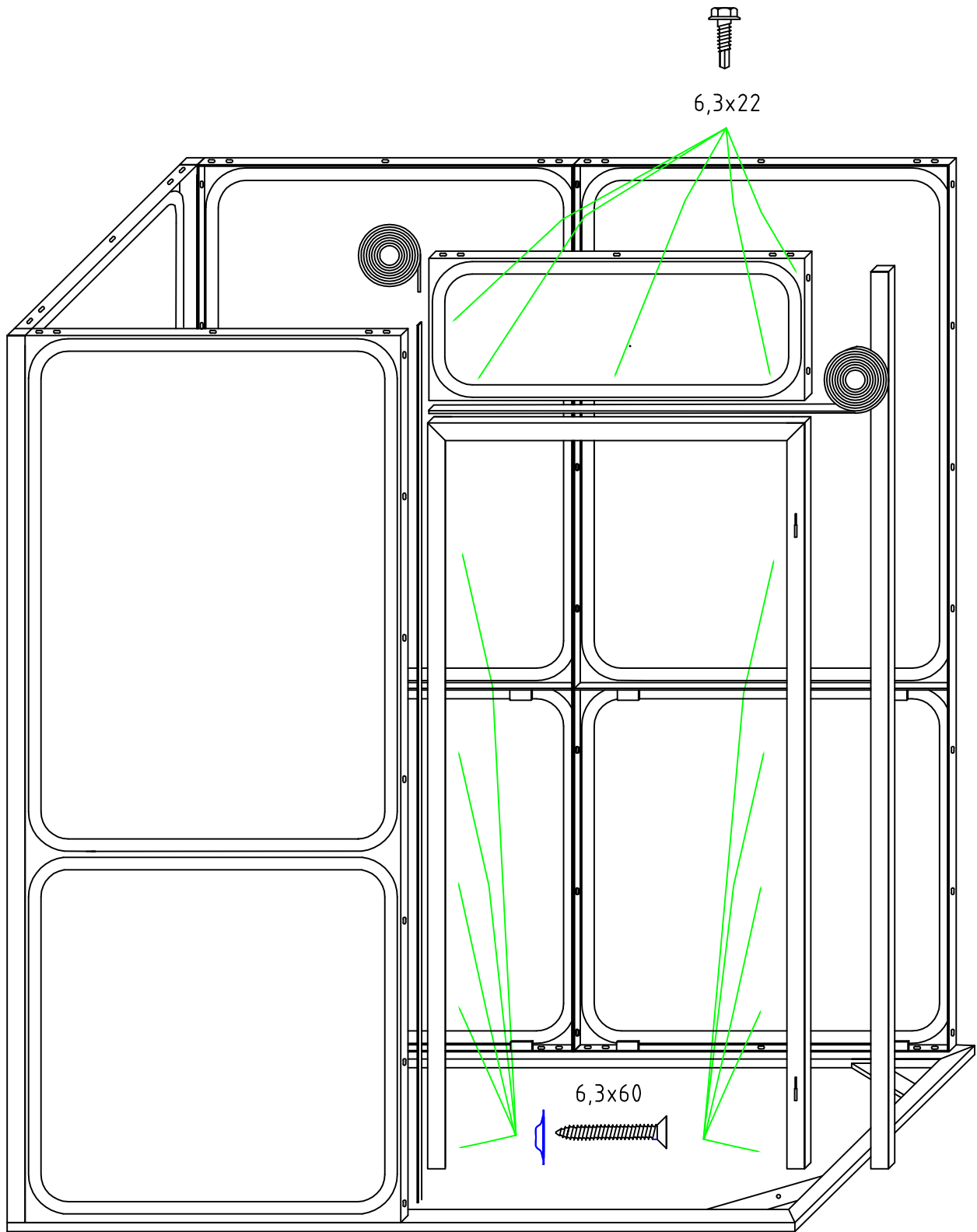

Abbildung 5.1
figure 5.1

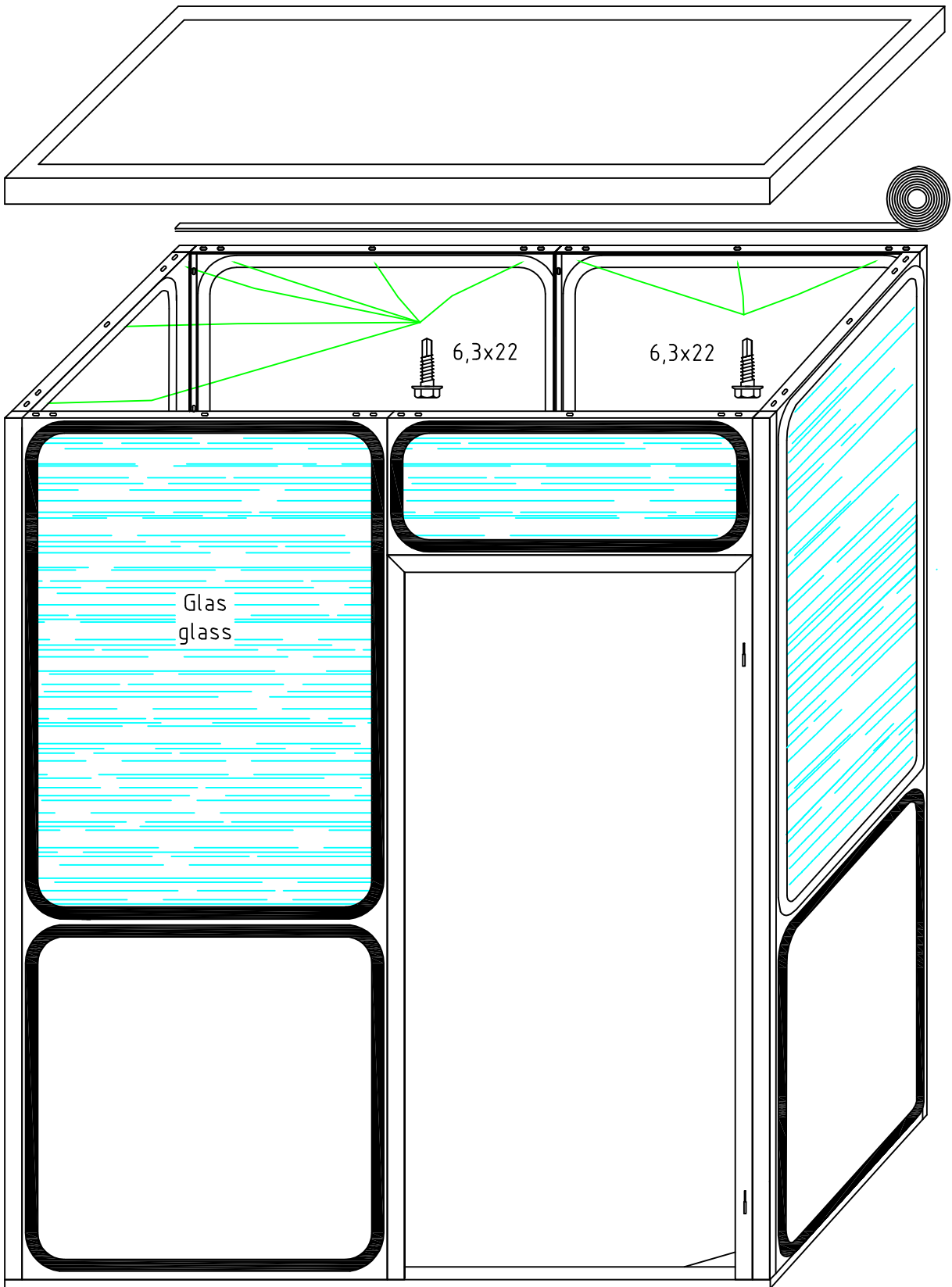

Abbildung 6
figure 6

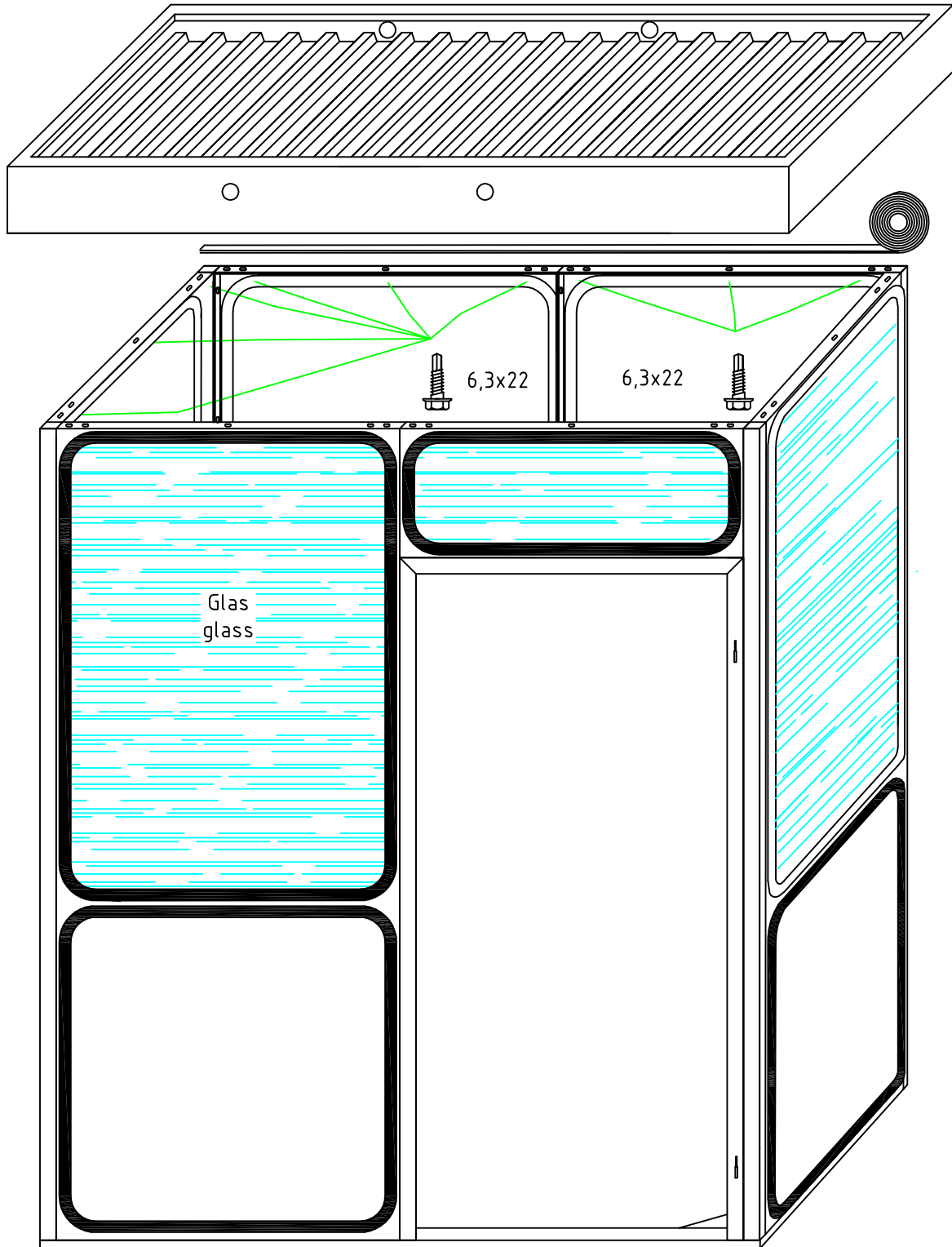

Abbildung 7
figure 7

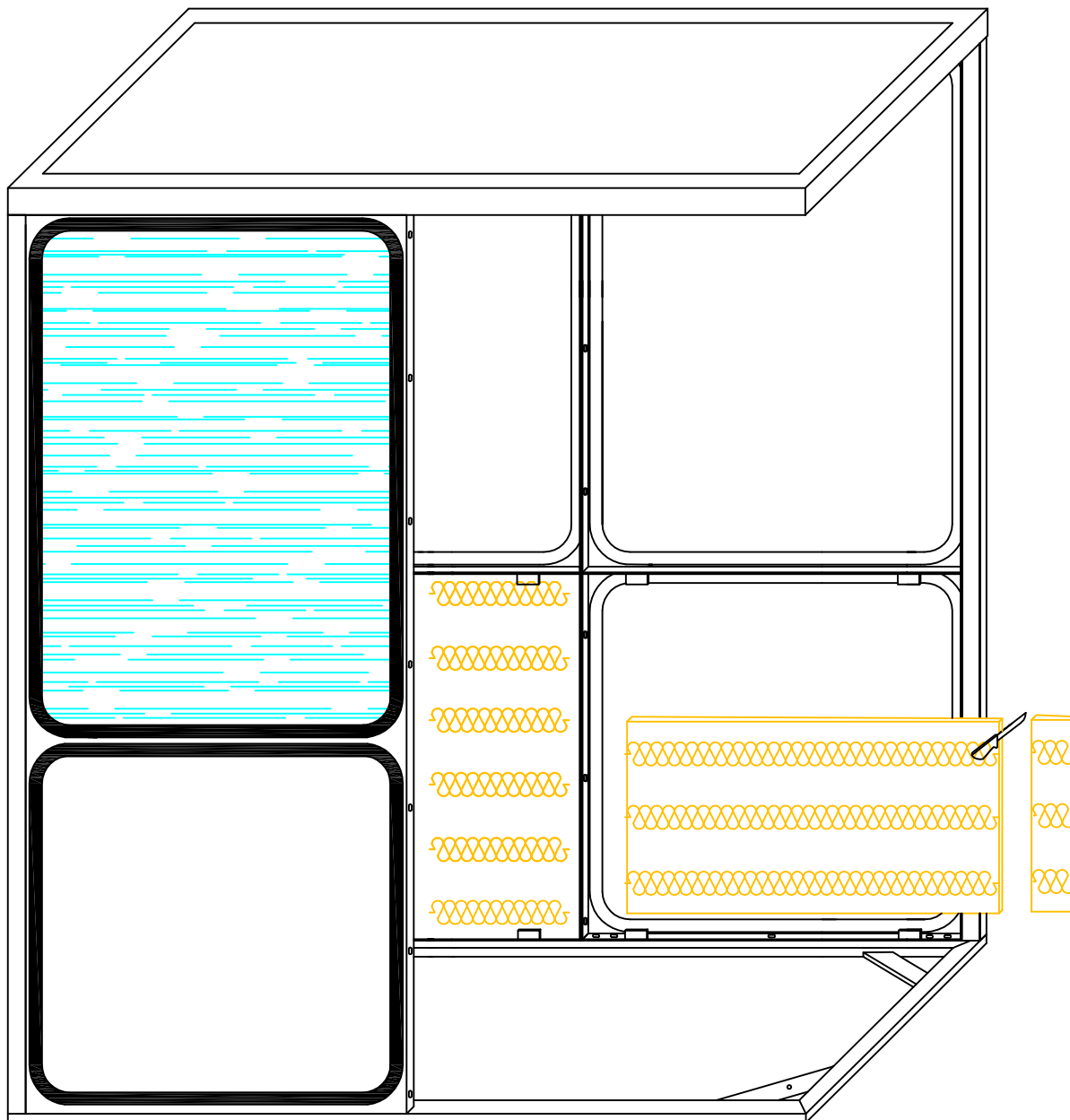

Abbildung 8.0
figure 8.0

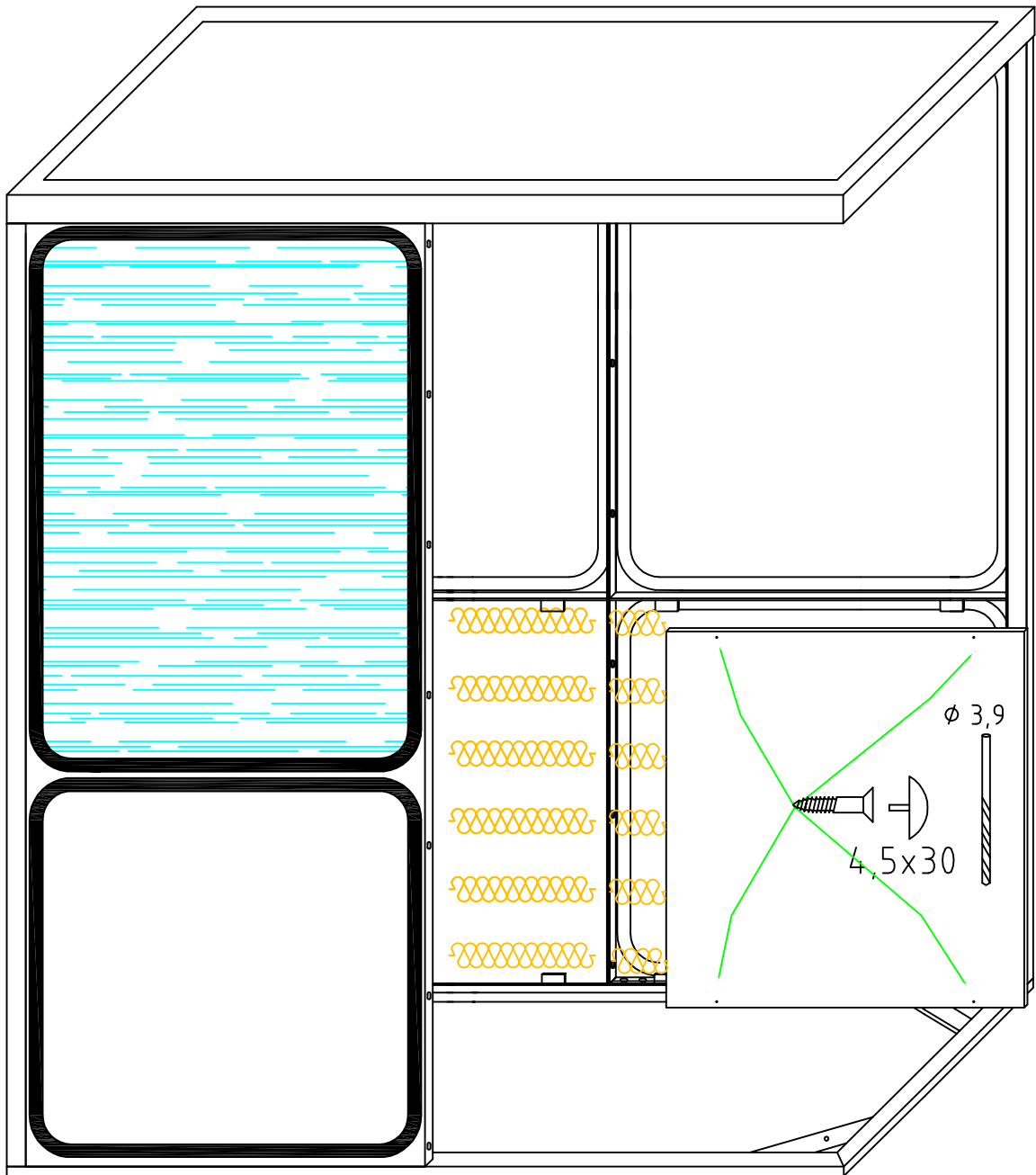

Abbildung 8.1
figure 8.1

Installation Instructions

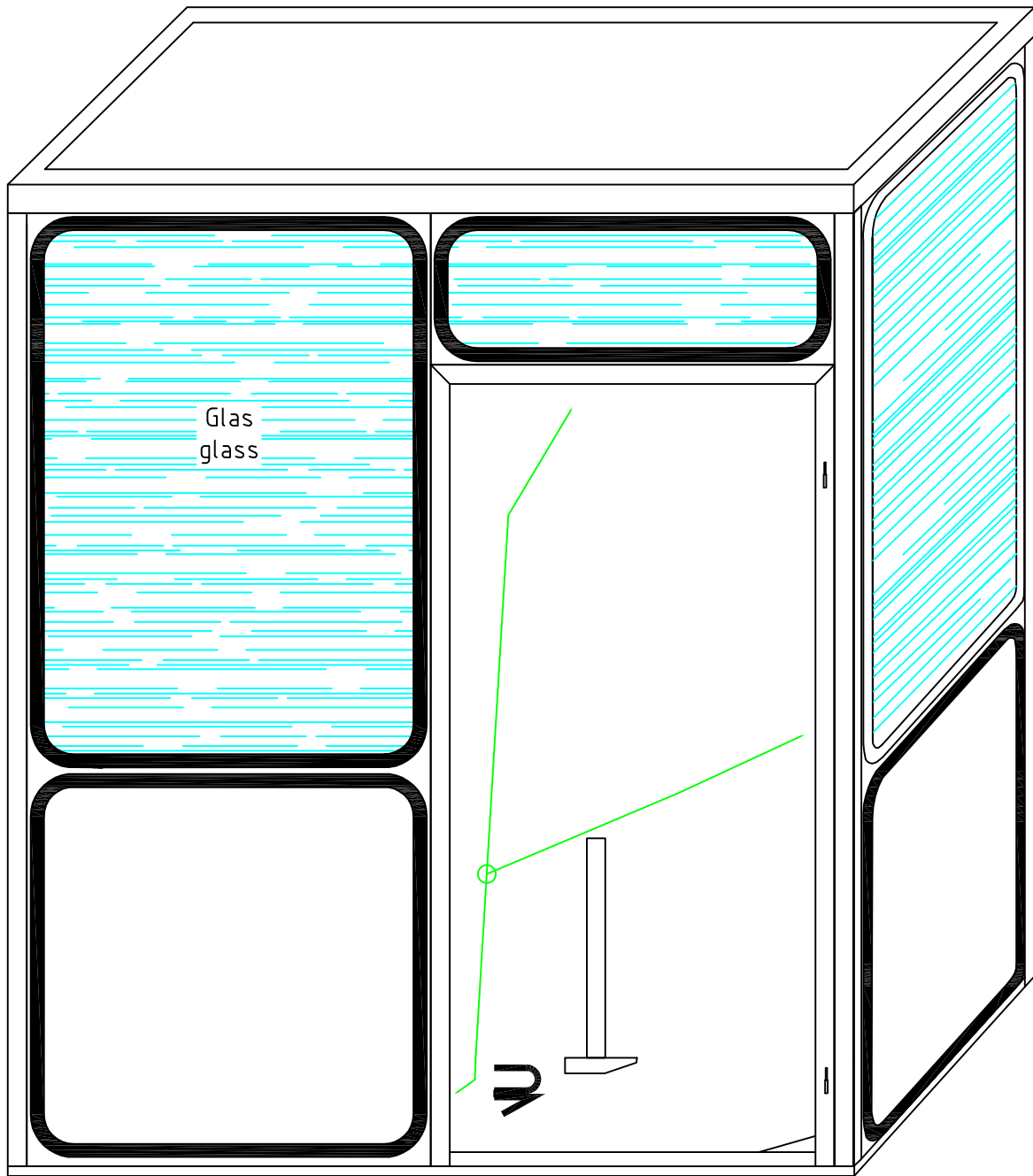
Multipurpose Building
Model with
rounded corners
Type MR

Options:
Floor
Internal cladding

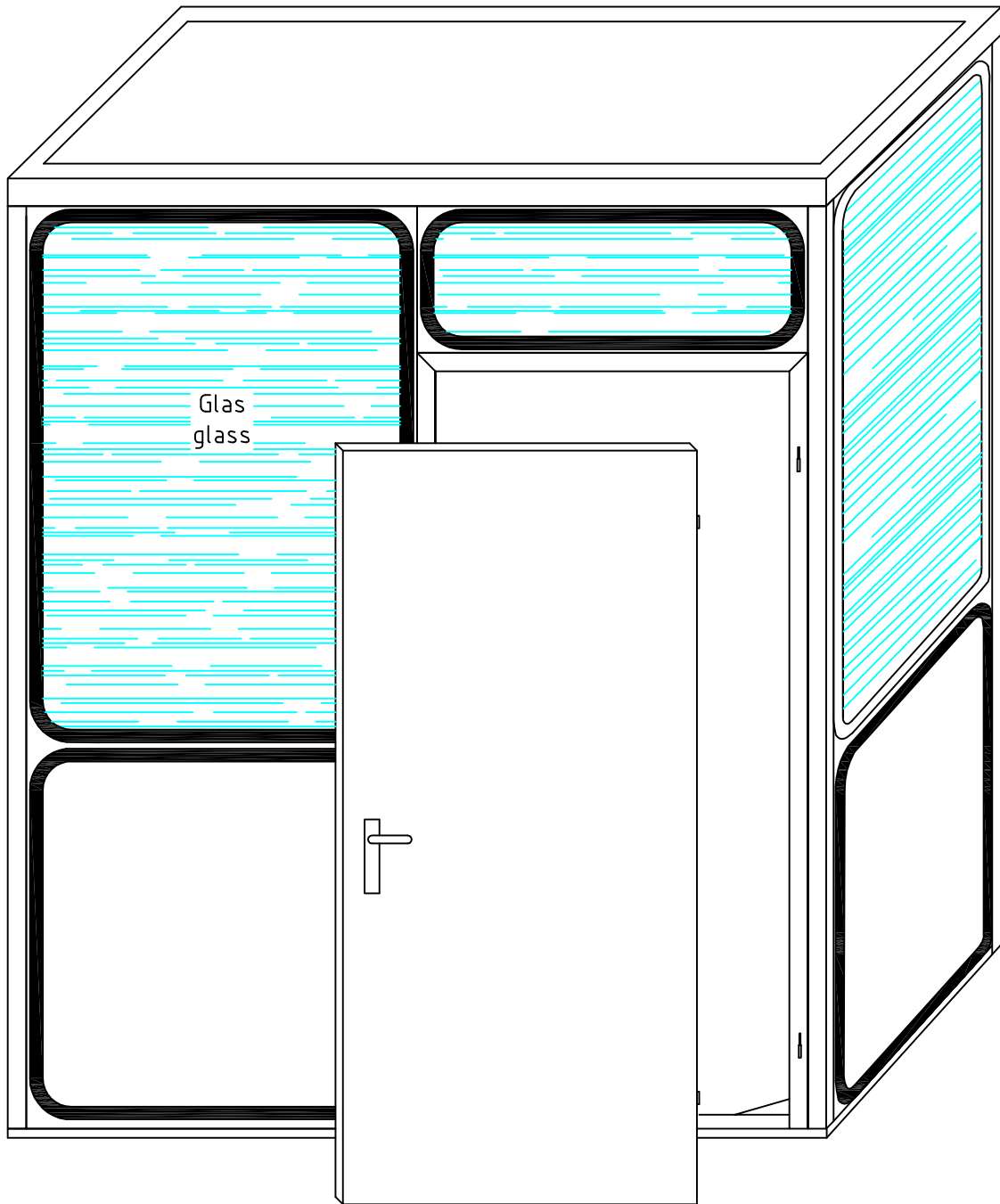
Installation Instructions

Modular Room System

1. Line up bottom frame (assembly frame or optional floor). (fig. 1)
2. Glue sealing tape on frame. (fig. 1)
3. Glue sealing tape on long side of roof elements. (fig. 2)
4. Screw corner post on wall panel using metal screws. (fig. 2)
5. Place wall panel with corner post on bottom frame and screw with metal screws. (fig. 3)
6. Line up wall panels, posts and door frame and screw them together. (fig. 4.0–4.2)
7. Glue sealing tape on top border of wall panels. (fig. 5.0 – 5.1)
8. Put roof frame on wall panels and screw, using metal screws. Indoor roof (fig. 5.0) – outdoor roof (fig. 5.1)
9. Install door. (fig. 8.0 – 8.1)



Internal cladding (panels)

10. Place mineral wool at the interior side of metal panels. (fig. 6)
11. Screw the white chipboard 13 mm with screws 4,5 x 30 mm on wall panels. (fig. 7)
12. Attach skirting.



Design changes are reserved.



Abbildung 1
figure 1



Abbildung 2
figure 2

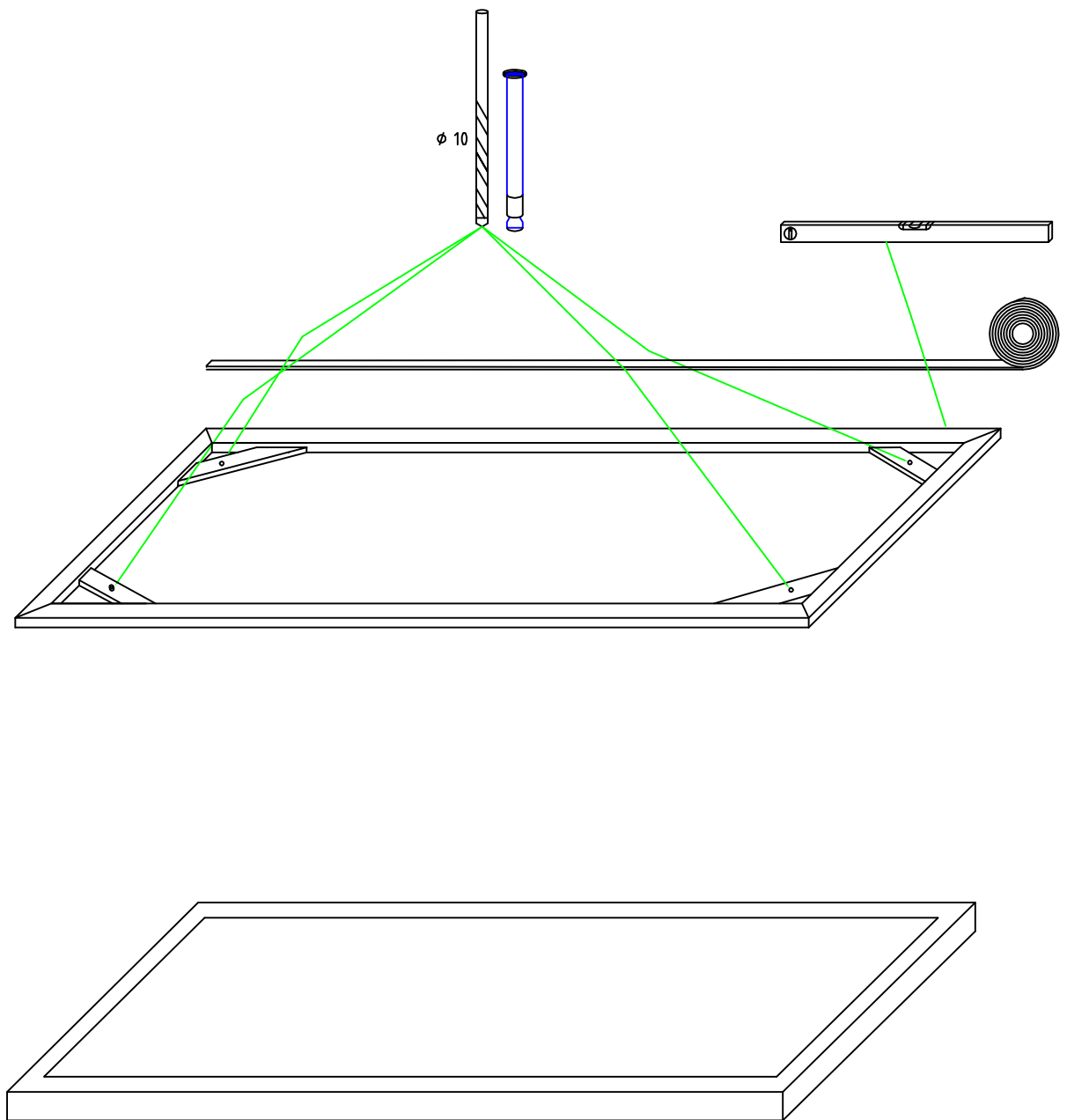

Abbildung 3
figure 3

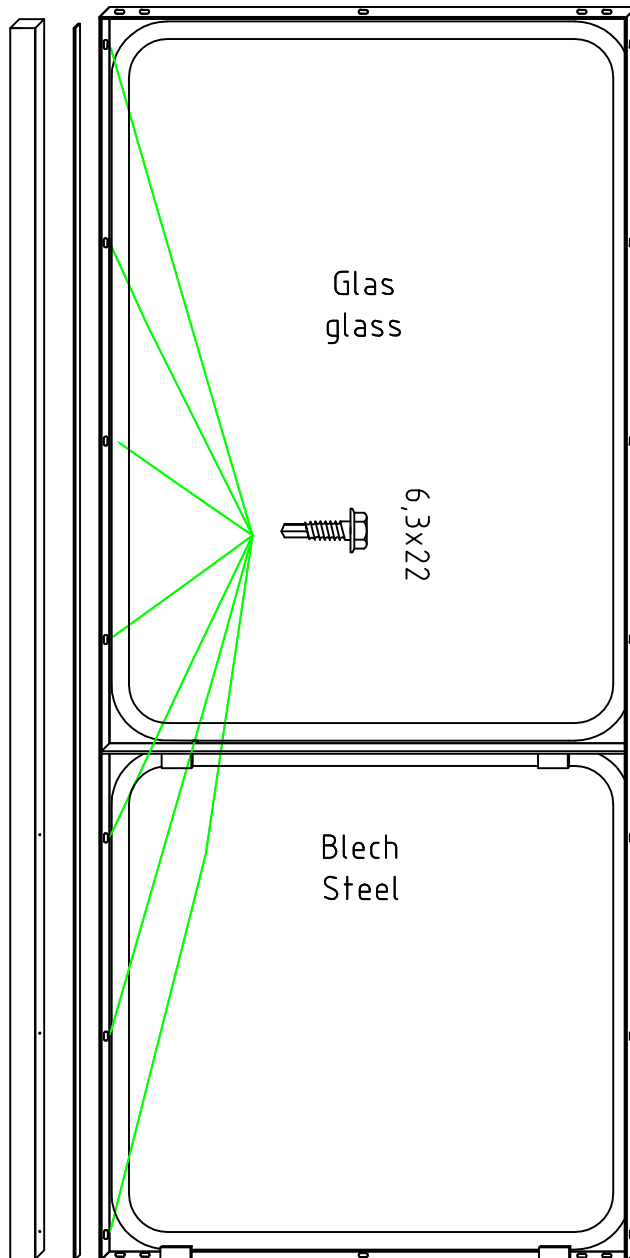

Abbildung 4.0
figure 4.0

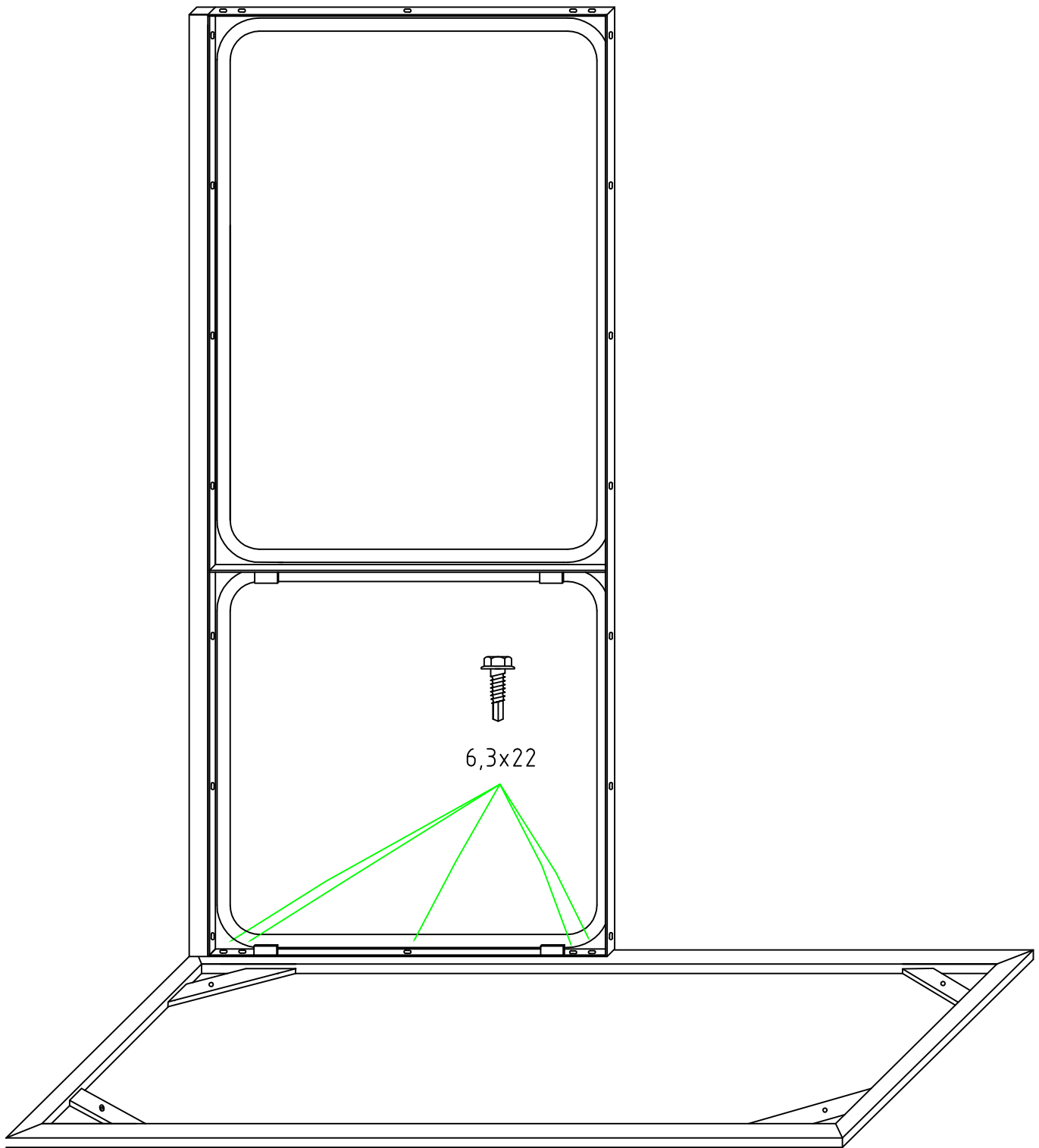

Abbildung 4.1
figure 4.1

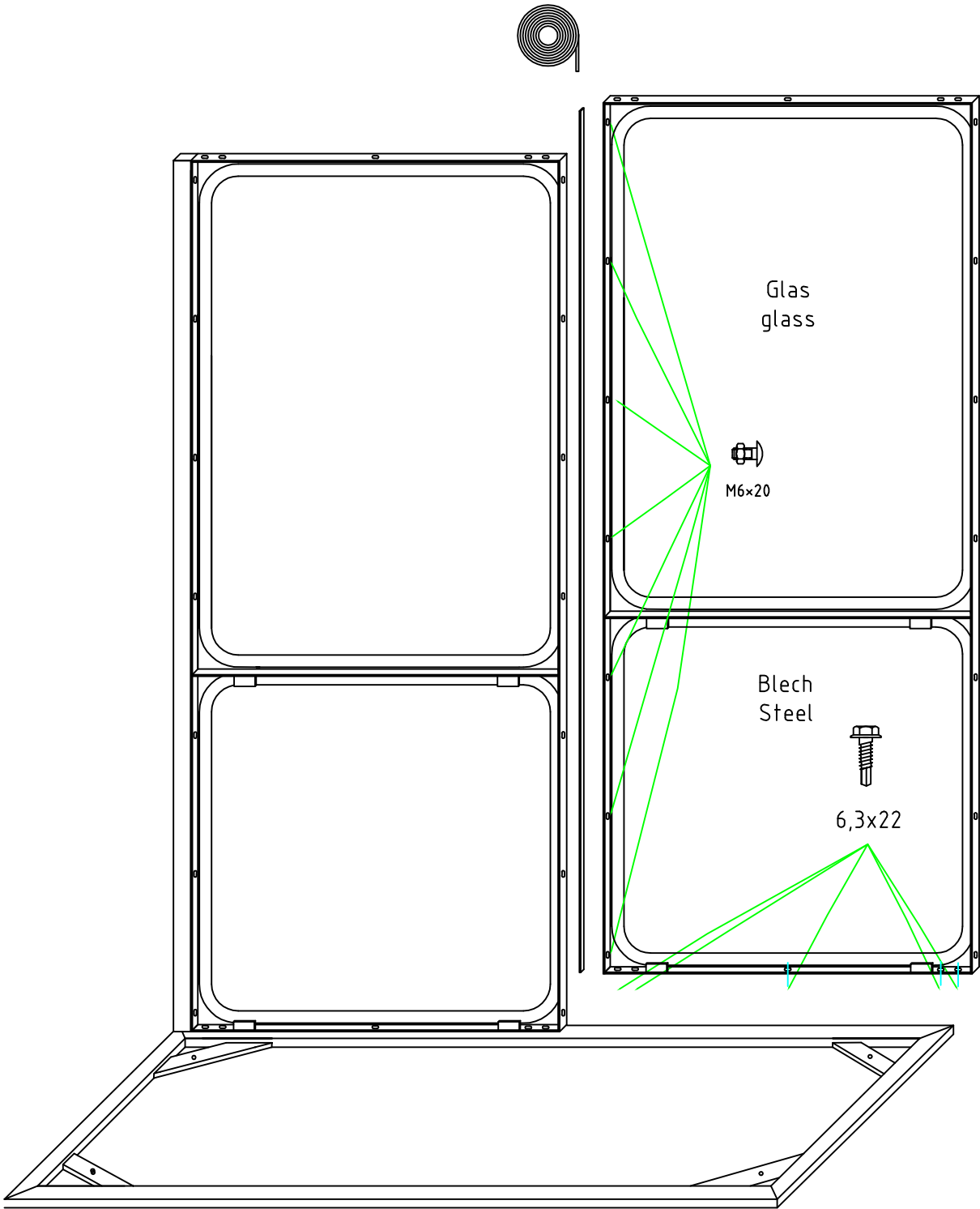

Abbildung 4.2
figure 4.2

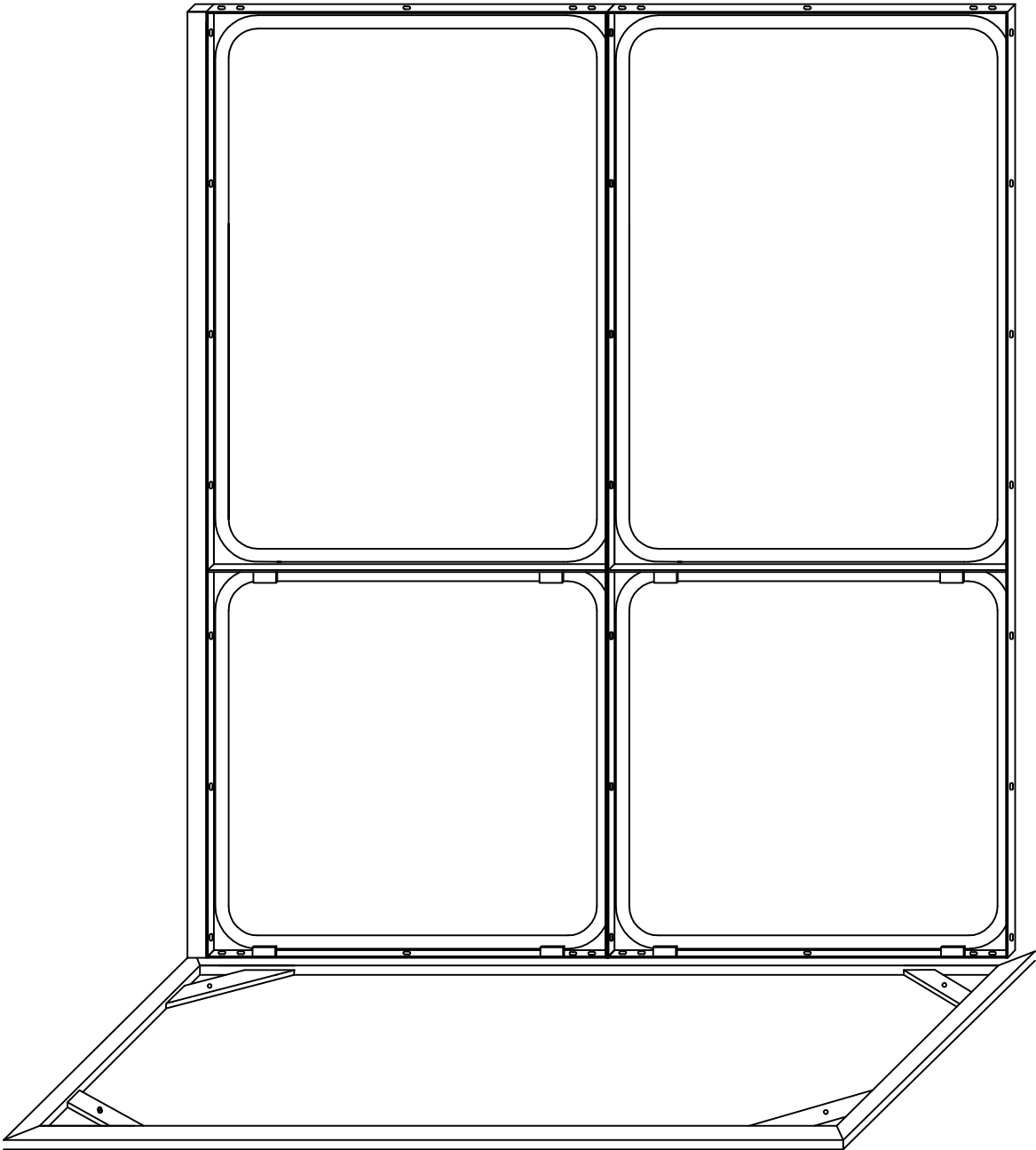

Abbildung 5.0
figure 5.0

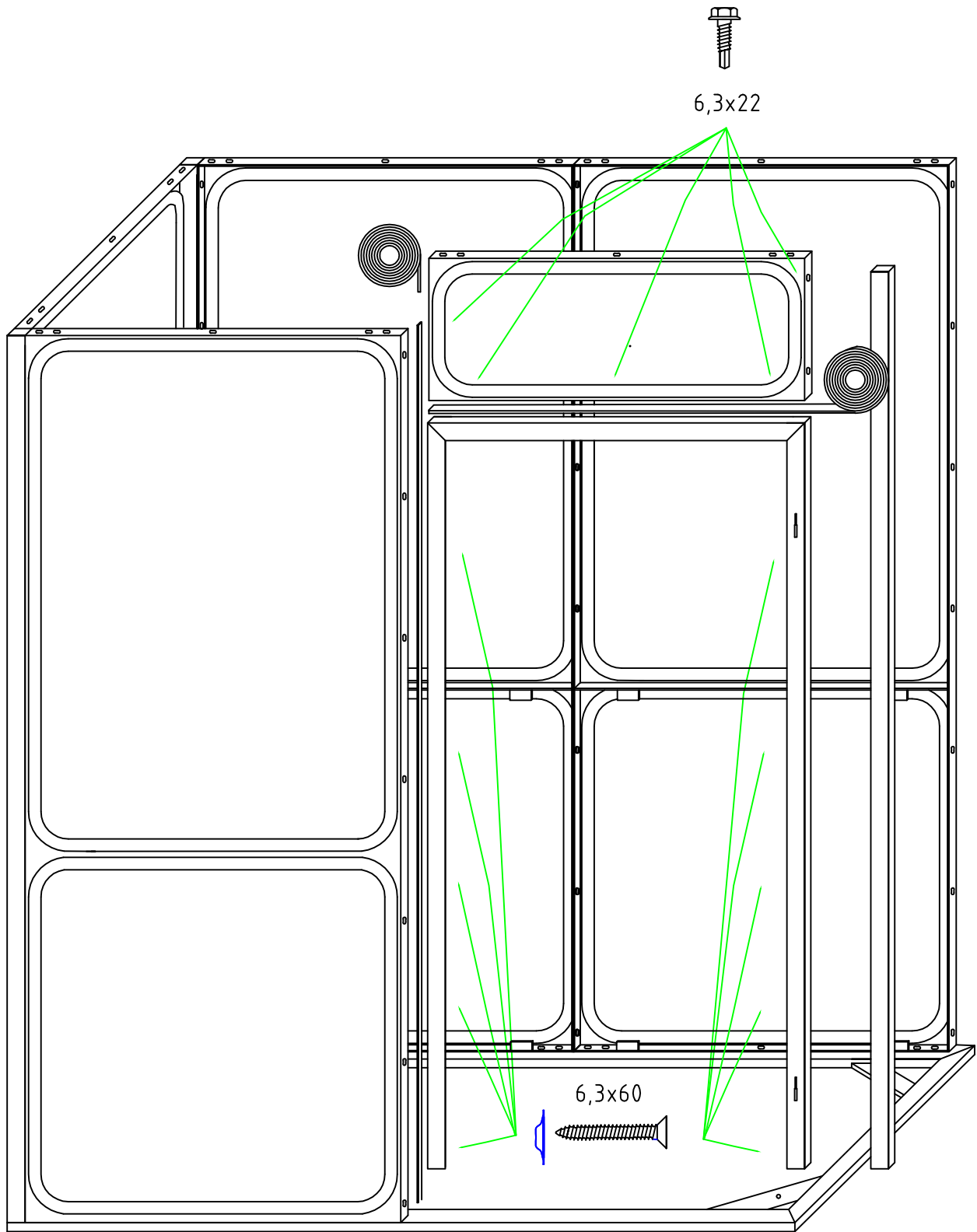

Abbildung 5.1
figure 5.1

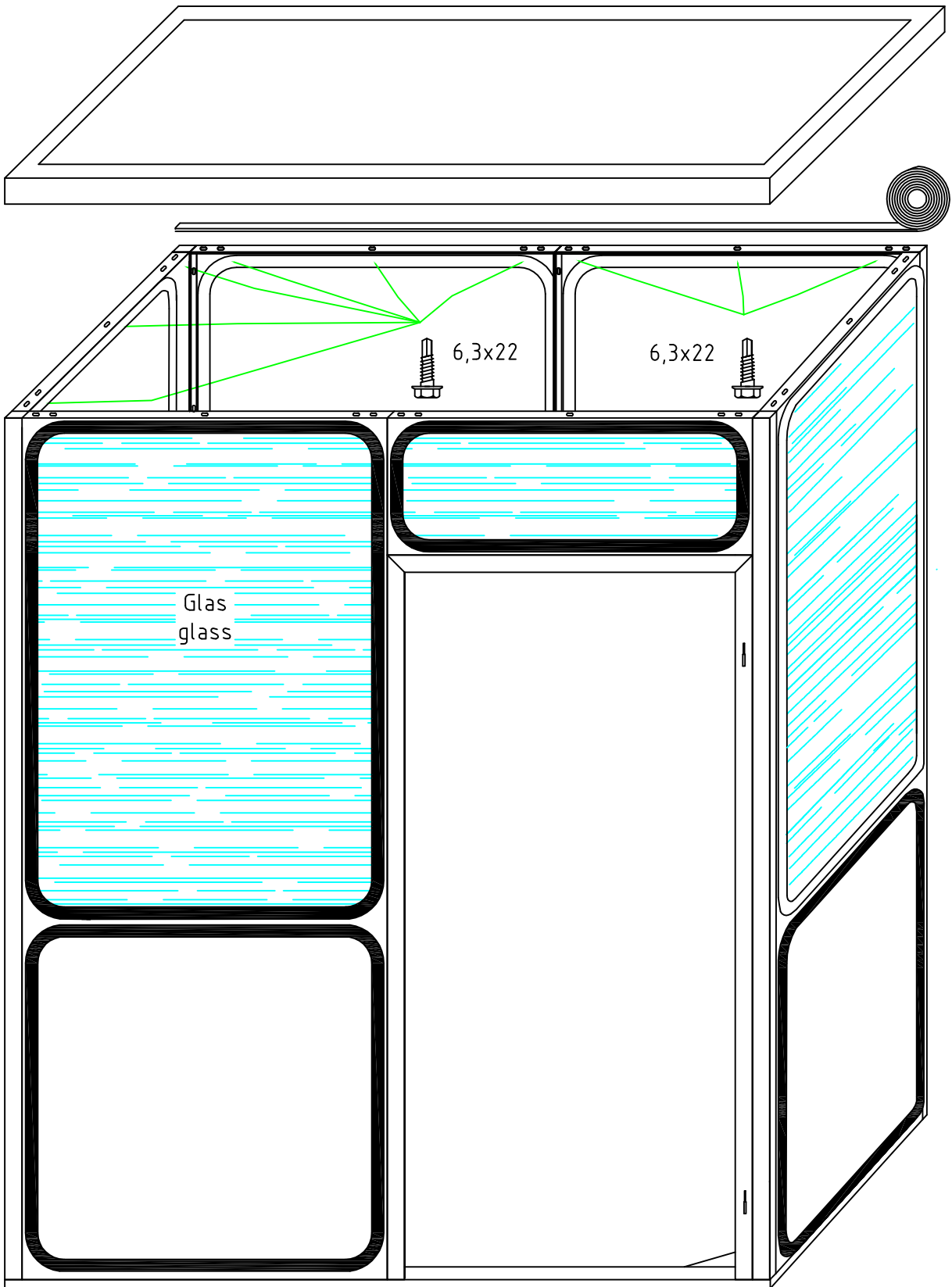

Abbildung 6
figure 6

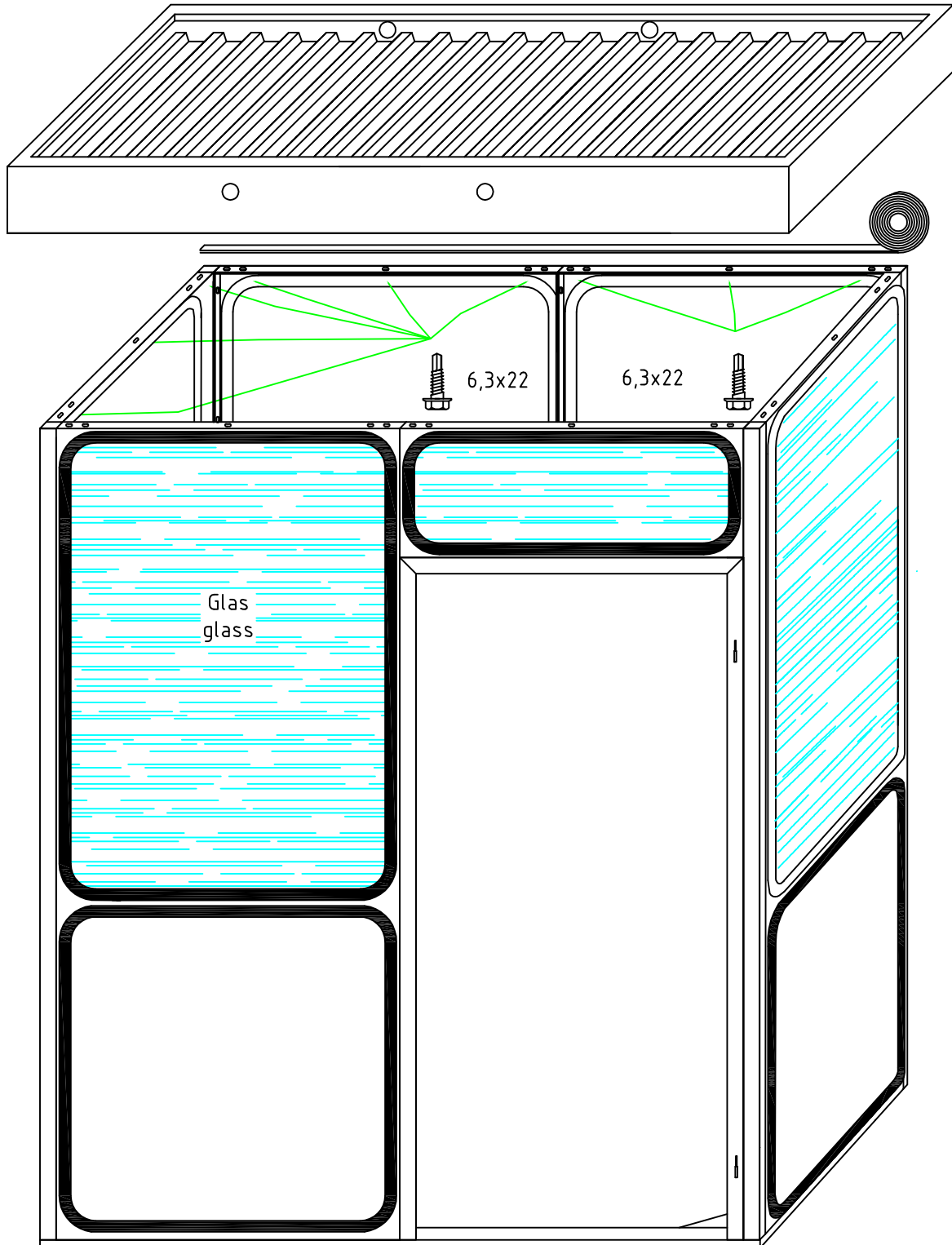

Abbildung 7
figure 7

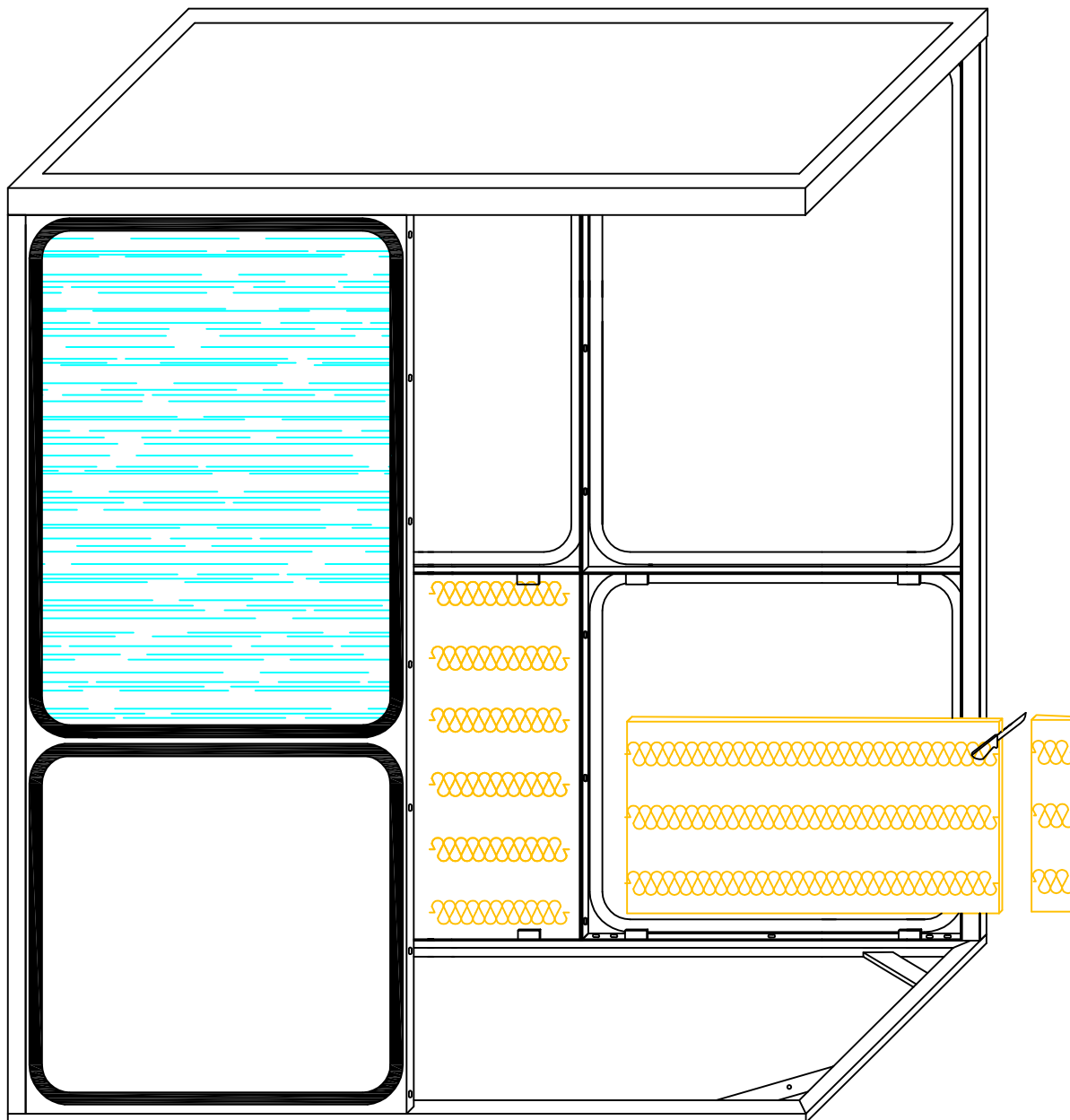

Abbildung 8.0
figure 8.0

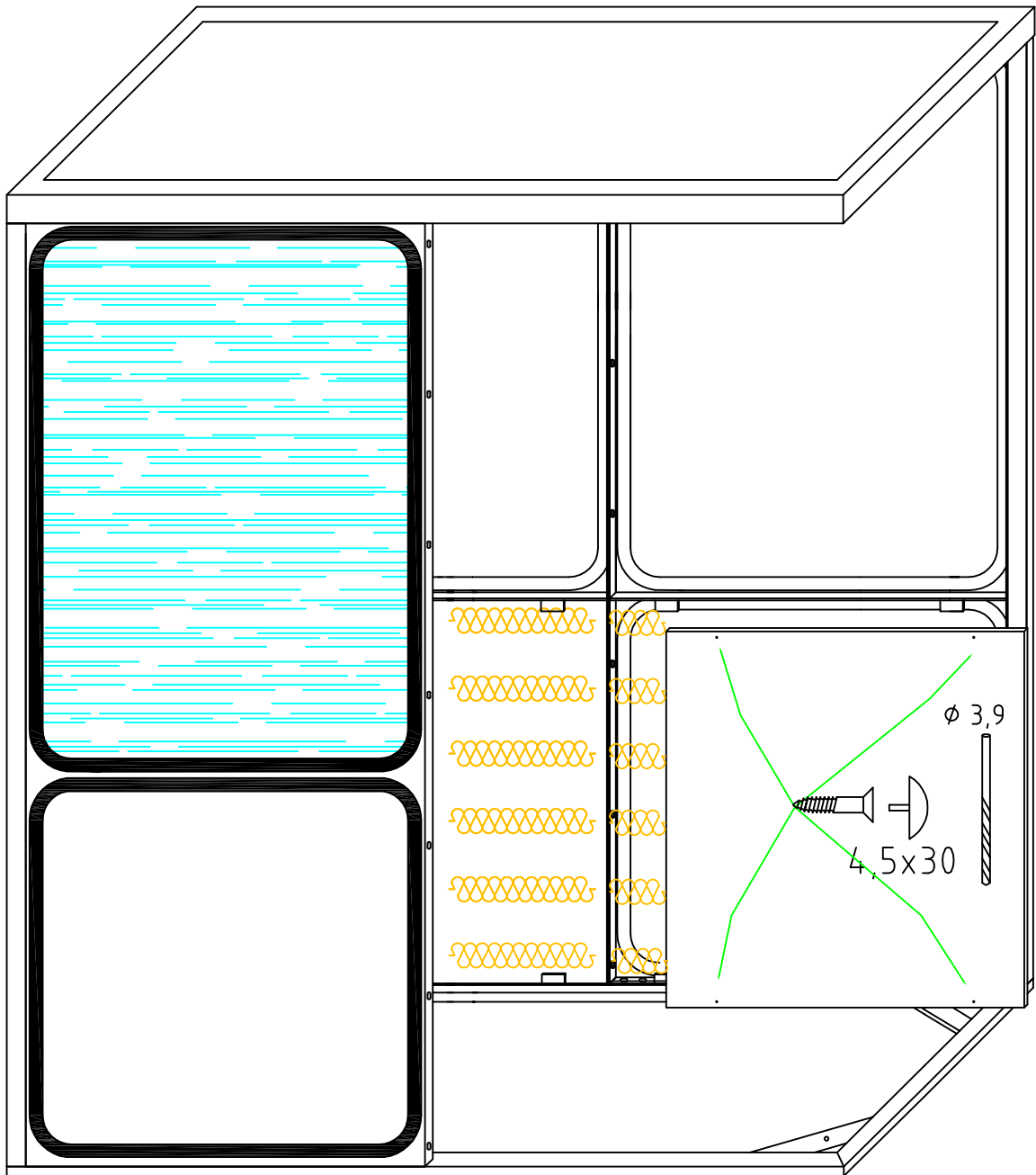

Abbildung 8.1
figure 8.1

Description de Montage

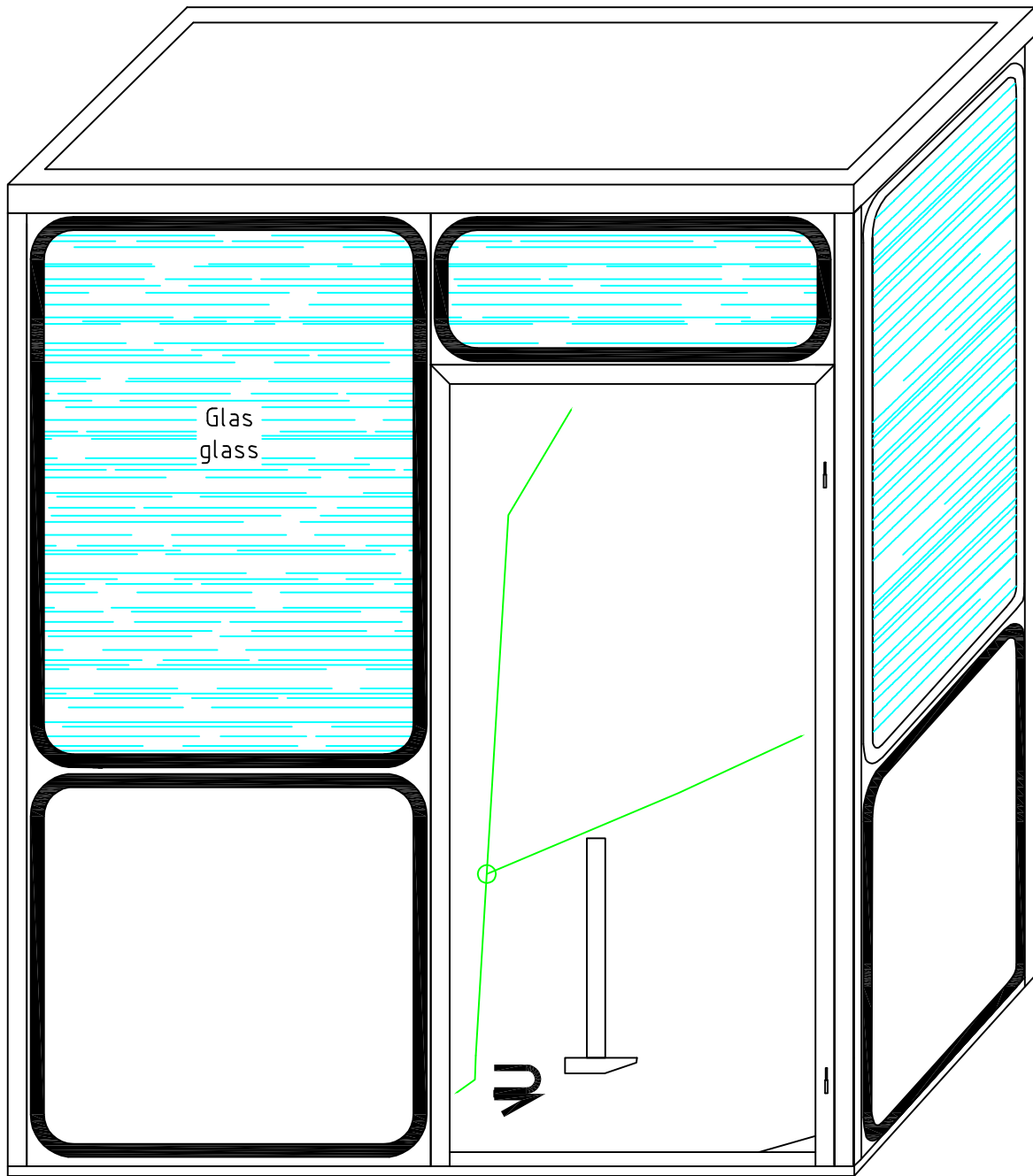
Cabines multi-usages
Modèle á angles arrondis
Type de MR

En option:
Plancher
Habillage intérieur
et isolation

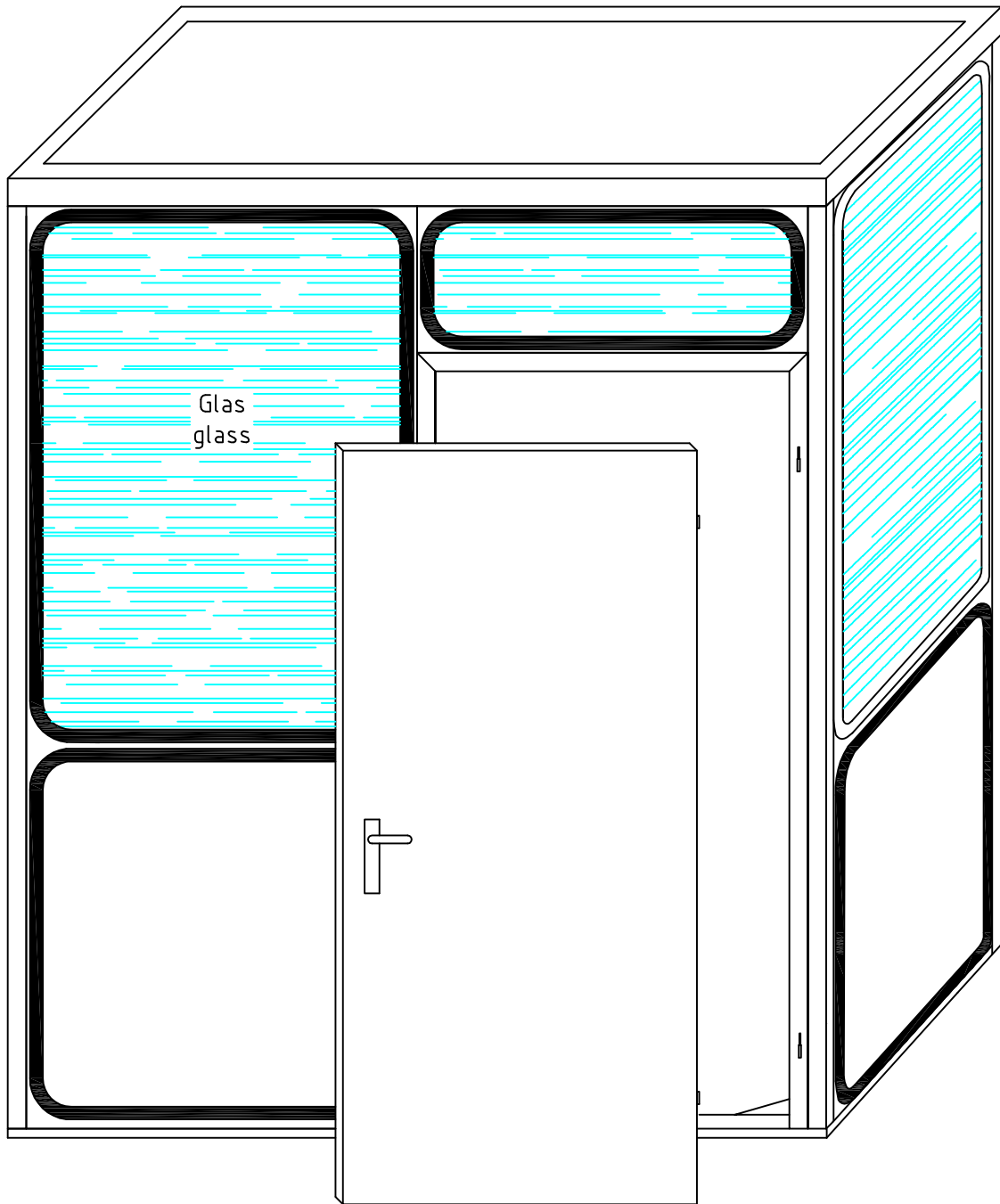
Instructions d'installation

Système de parois modulaires



1. Aligner le cadre de fond (Cadre de montage châssis ou plancher). (Fig. 1)
2. Coller le bandeau de joint sur le cadre. (Fig. 1)
3. Coller le bandeau de joint sur le côté long des éléments de toit. (Fig. 2)
4. Visser le montant d'angle au éléments de parois en utilisant des vis à tôle.(Fig. 2)
5. Positionner la parois avec le montant d'angle sur le cadre de fond et visser à l'aide de vis à tôle. (Fig. 3)
6. Positionner les parois, les montants et la porte, et visser à l'aide de vis à tôle. (Fig. 4.0 – 4.2)
7. Coller le bandeau de joint sur le bord supérieur des parois. (Fig. 5.0 – 5.1)
8. Poser le cadre de toit et visser aux parois. Utiliser vis à tôle. Toit pour l'intérieur (Fig. 5.0) – Toit pour l'extérieur (Fig. 5.1)
9. Montage de porte. (Fig. 8.0 – 8.1)

Revêtement intérieur

10. Placer la isolation en laine minérale à l'intérieur des tôles. (Fig. 6)
11. Visser panneau d'aggloméré 13 mm à l'aide de vis à tôle 4,5 x 30 mm. Les couvrir de coiffes de protection. (Fig. 7)
12. Fixer plinthes.



Les changements de conception sont réservés.



Abbildung 1
Fig. 1



Abbildung 2
Fig. 2

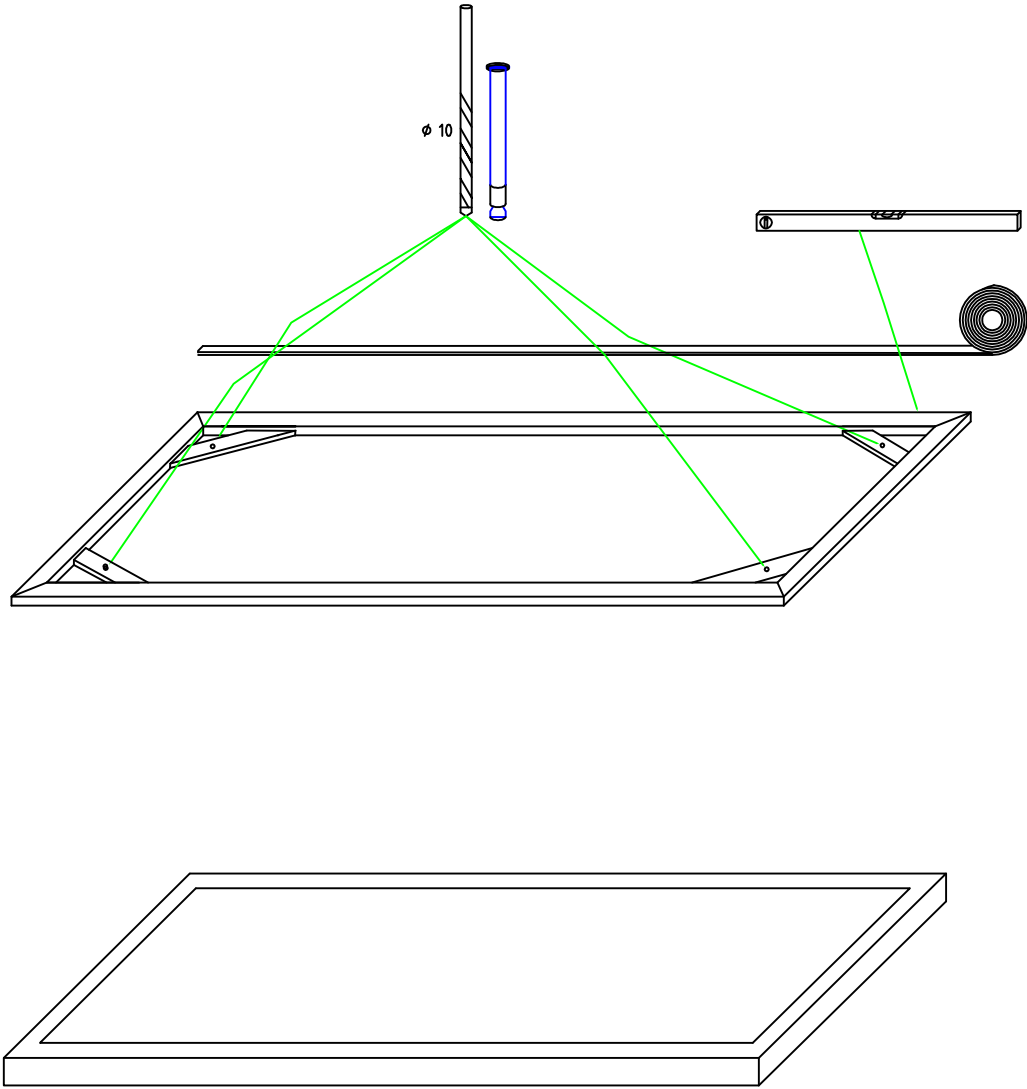

Abbildung 3
Fig. 3

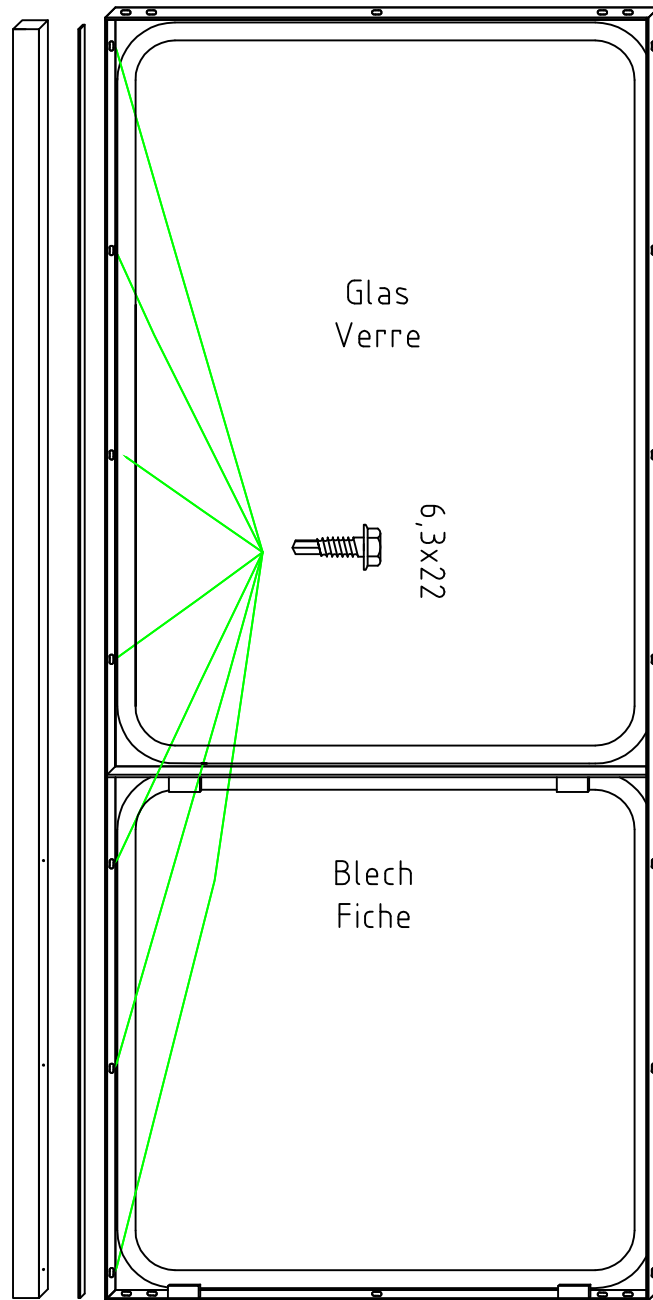

Abbildung 4.0
Fig. 4.0

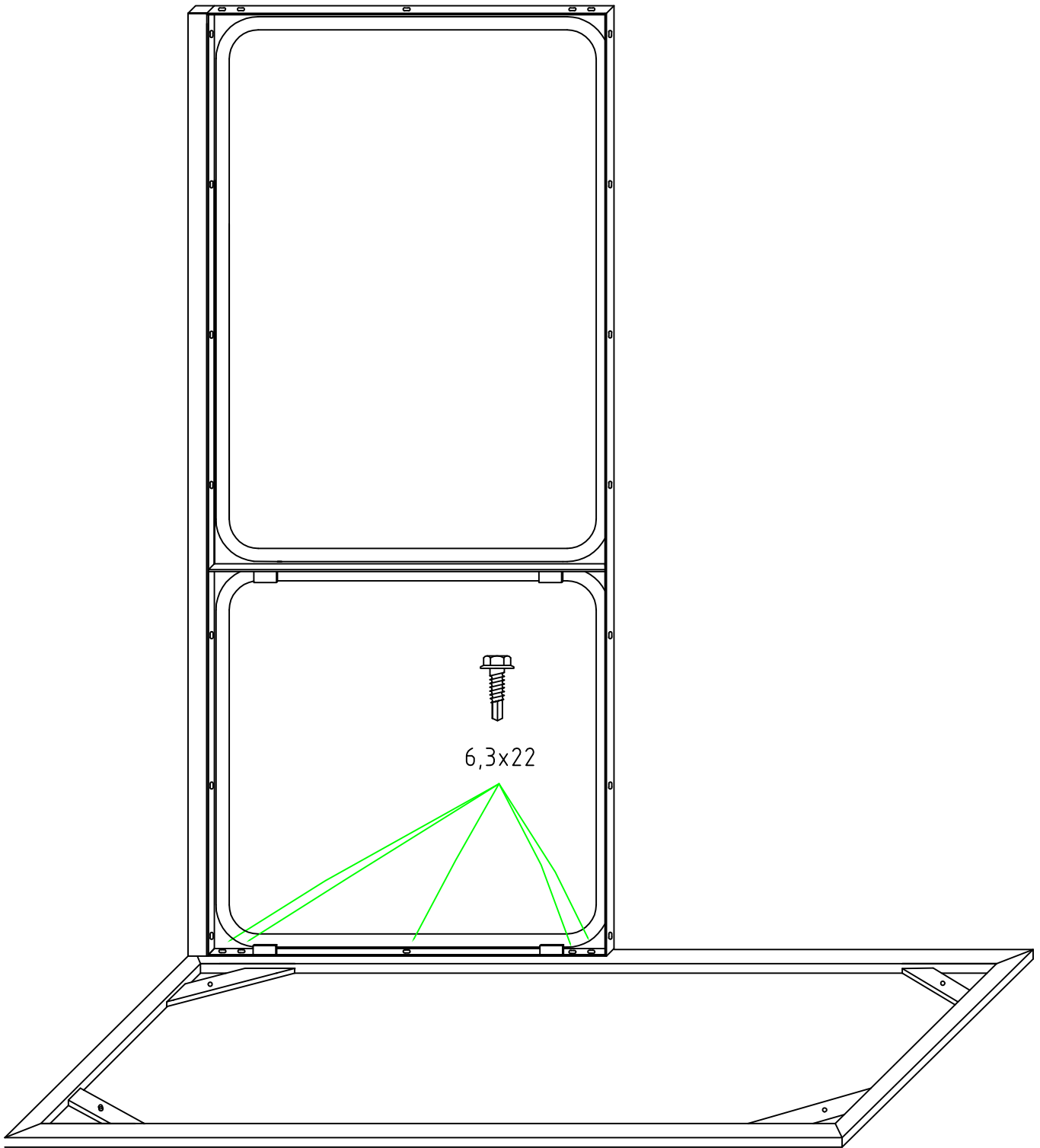

Abbildung 4.1
Fig. 4.1

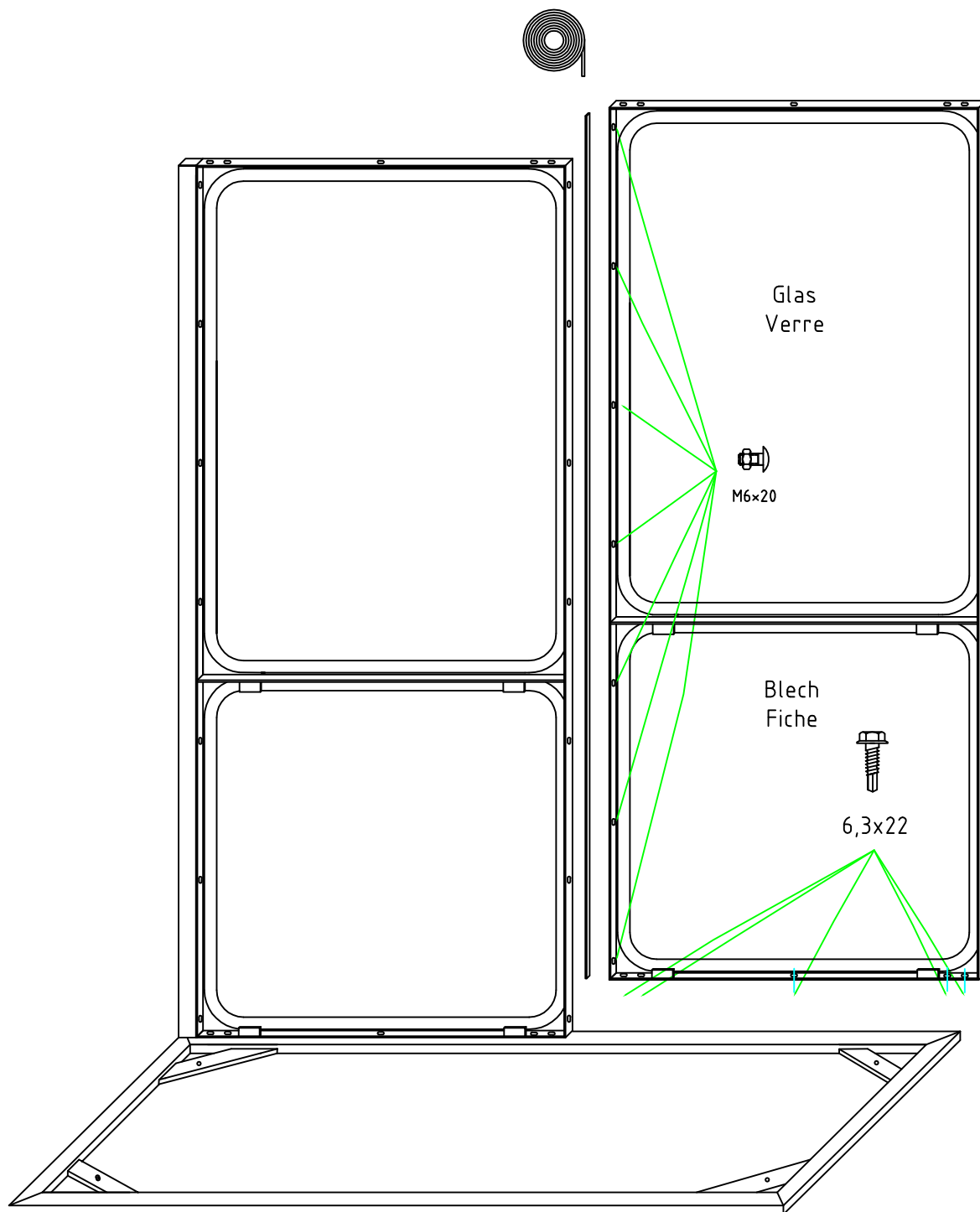

Abbildung 4.2
Fig. 4.2

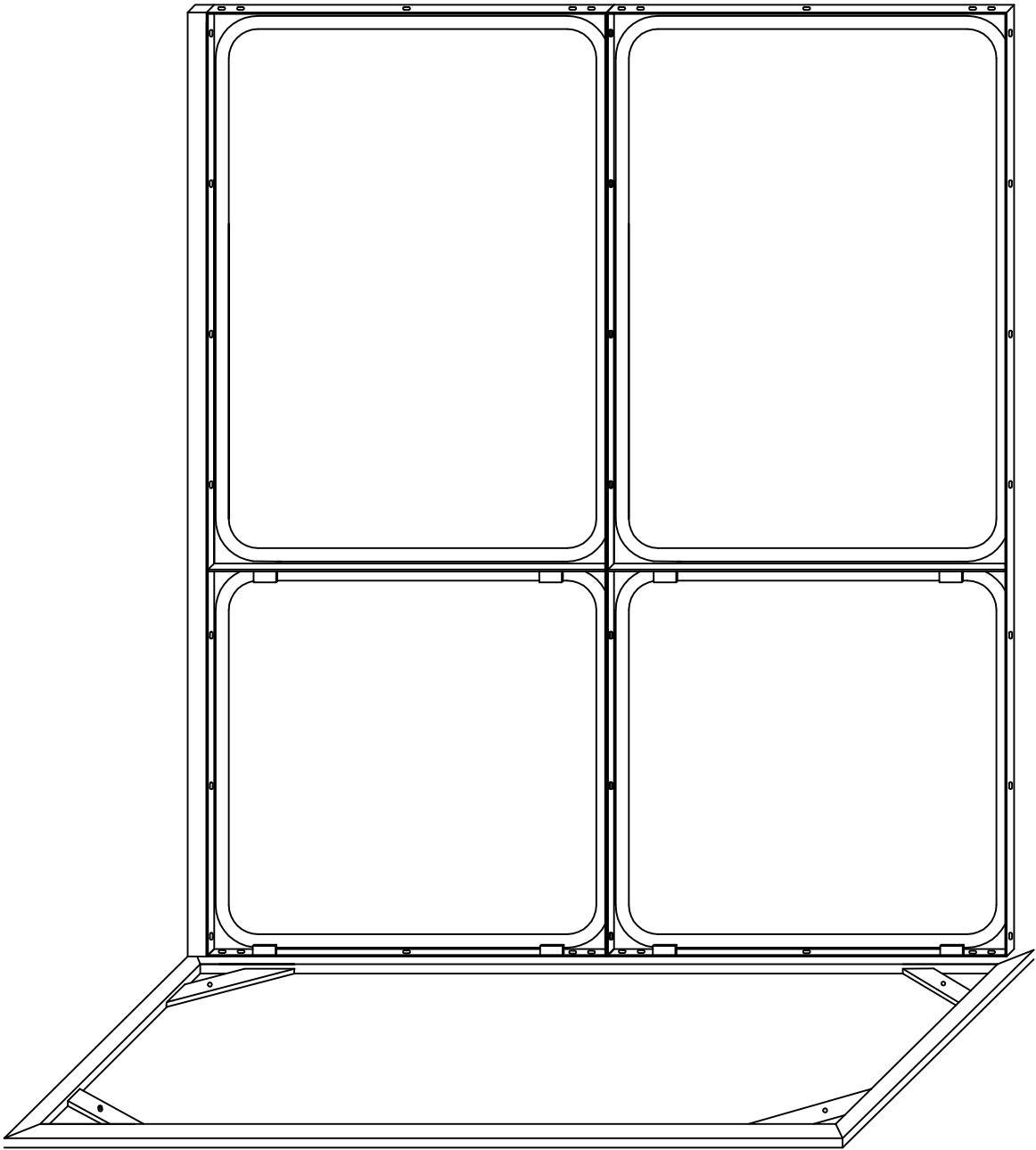

Abbildung 5.0
Fig. 5.0

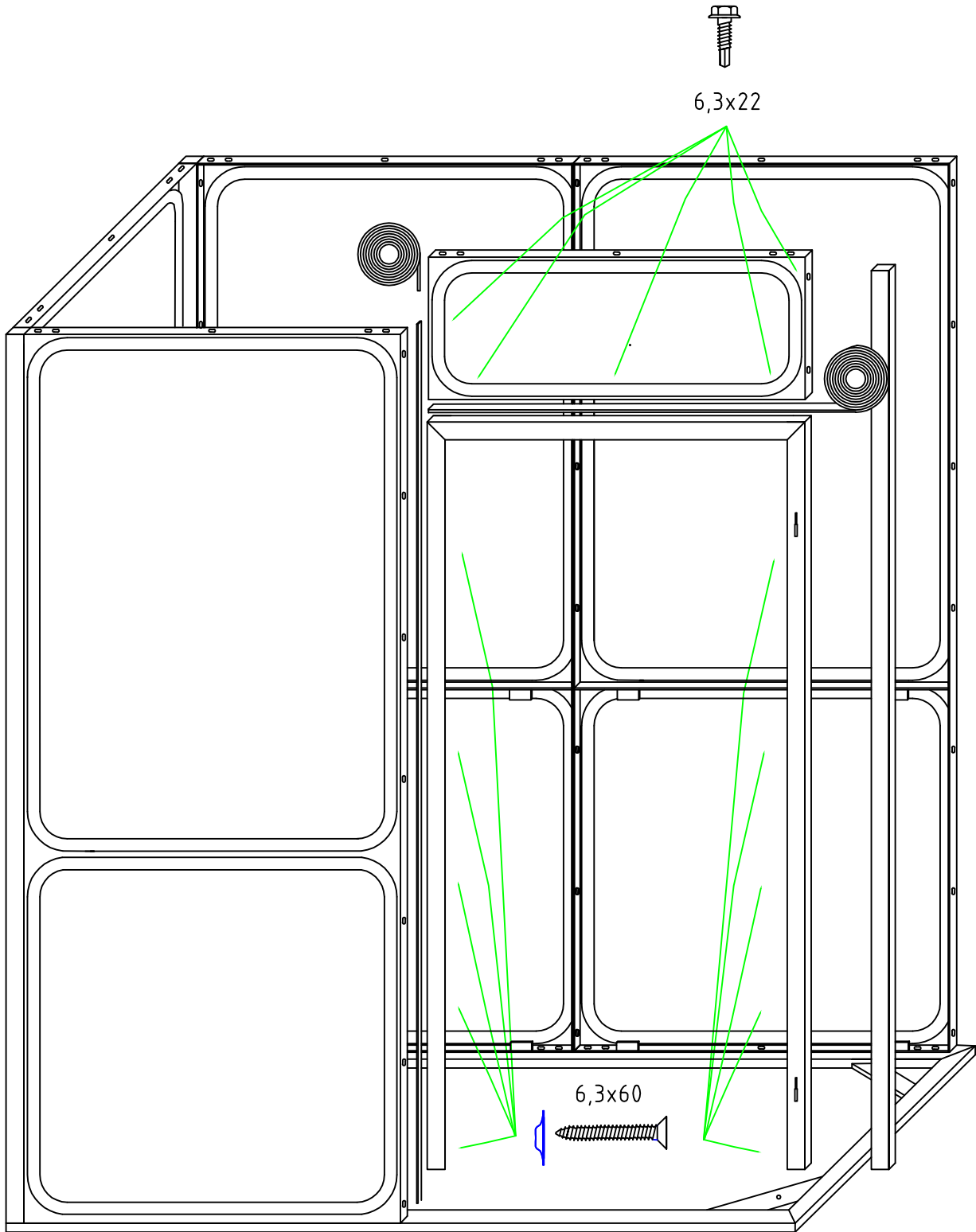

Abbildung 5.1
Fig. 5.1

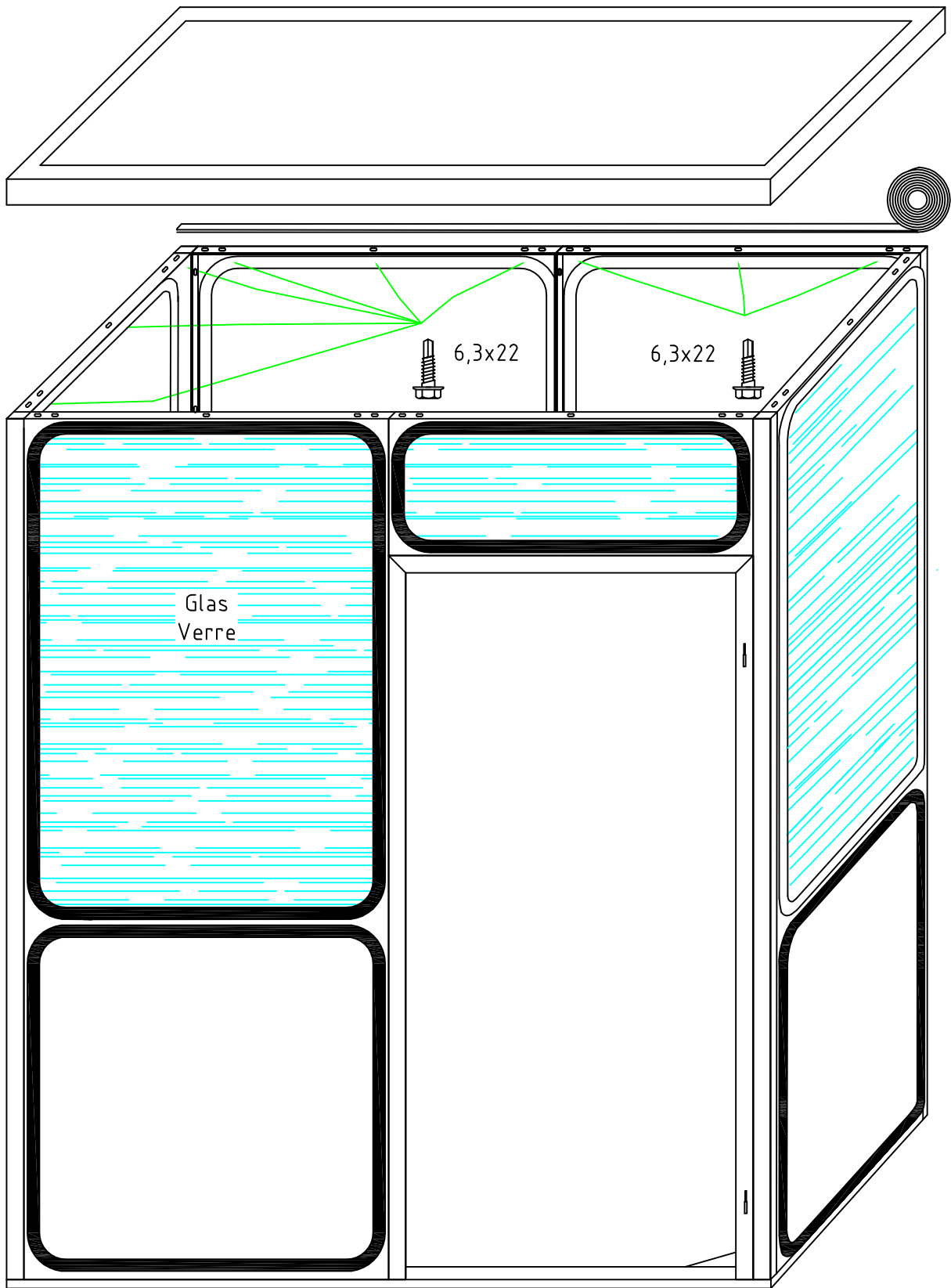

Abbildung 6
Fig. 6

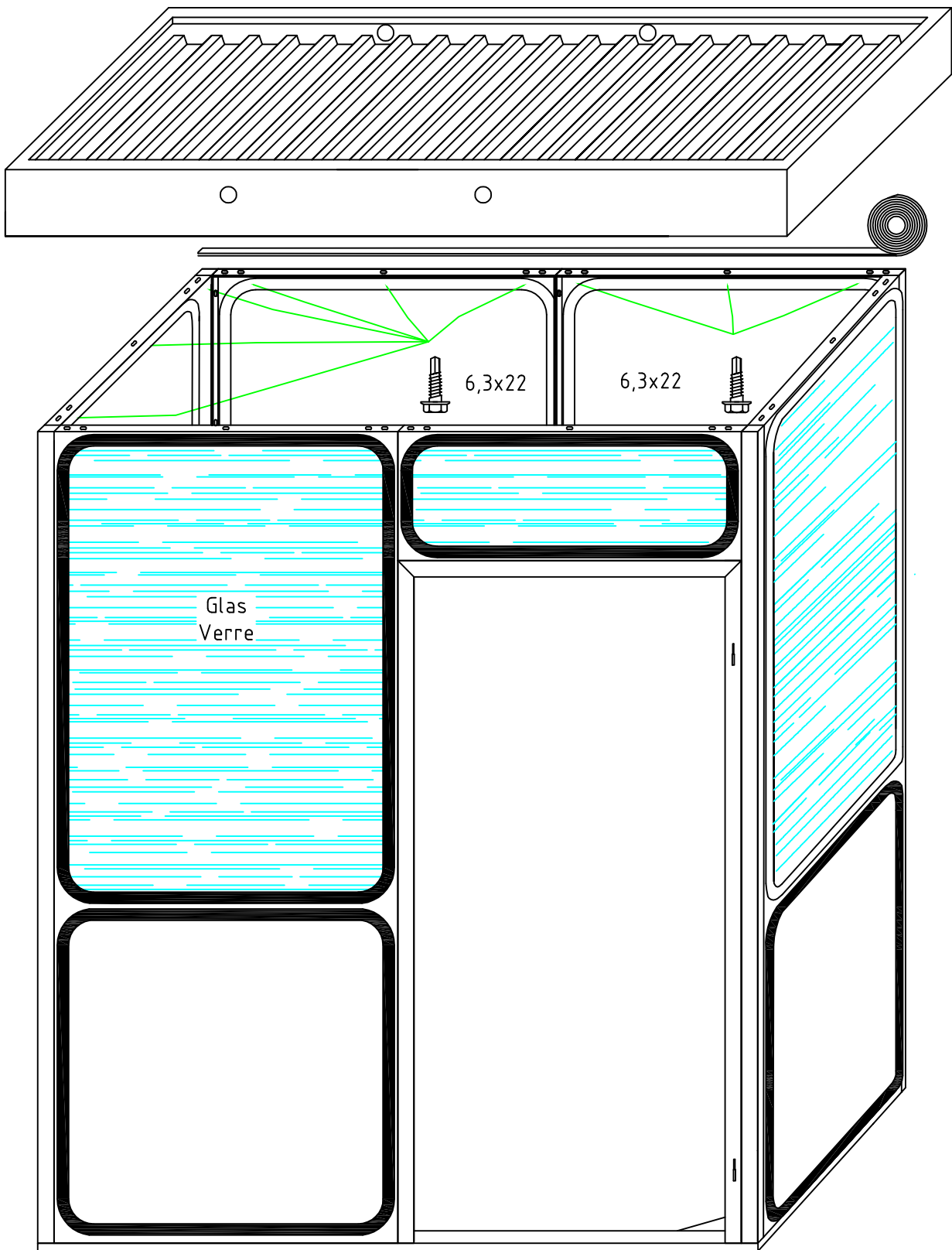

Abbildung 7
Fig. 7

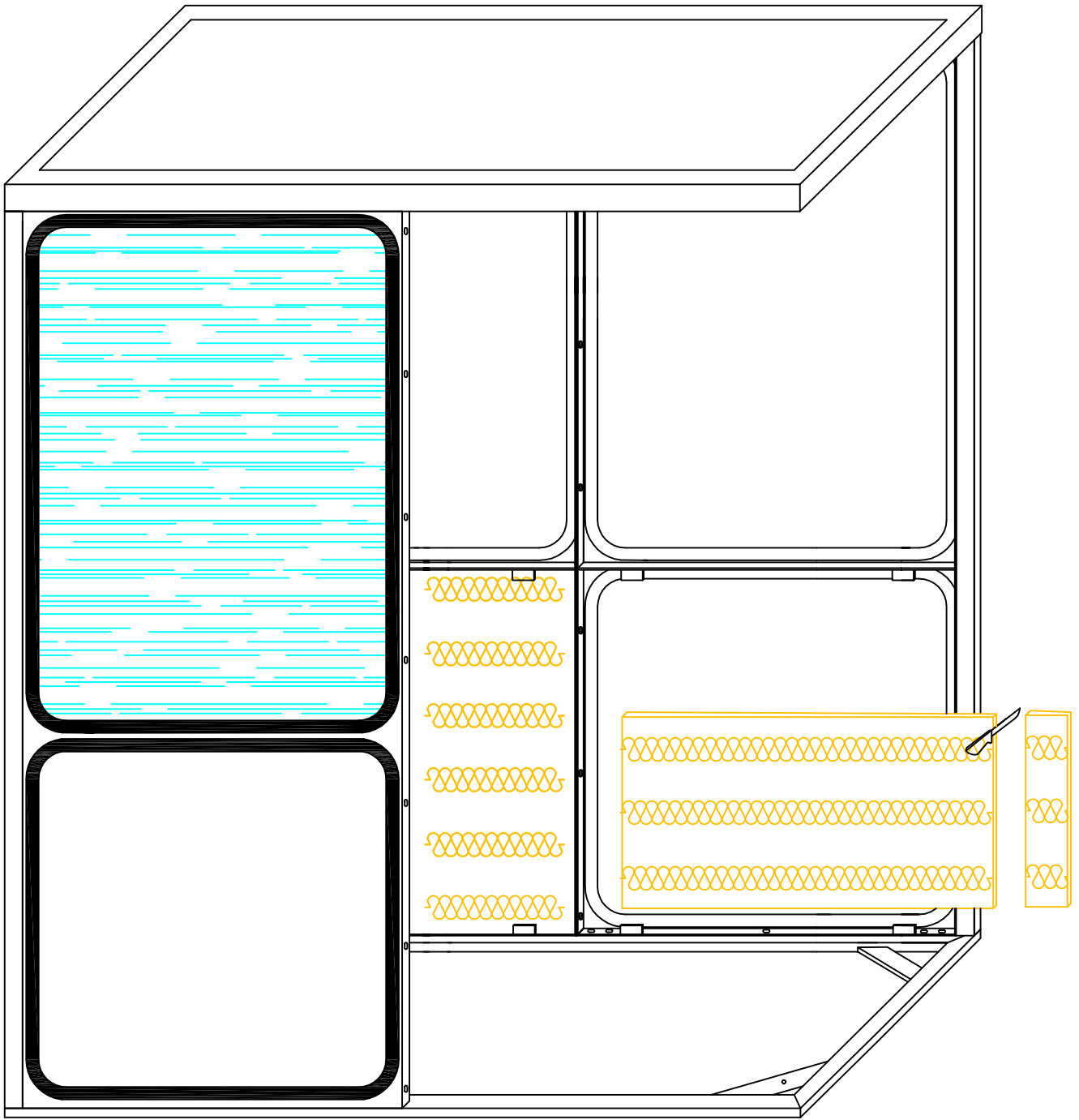

Abbildung 8.0
Fig. 8.0

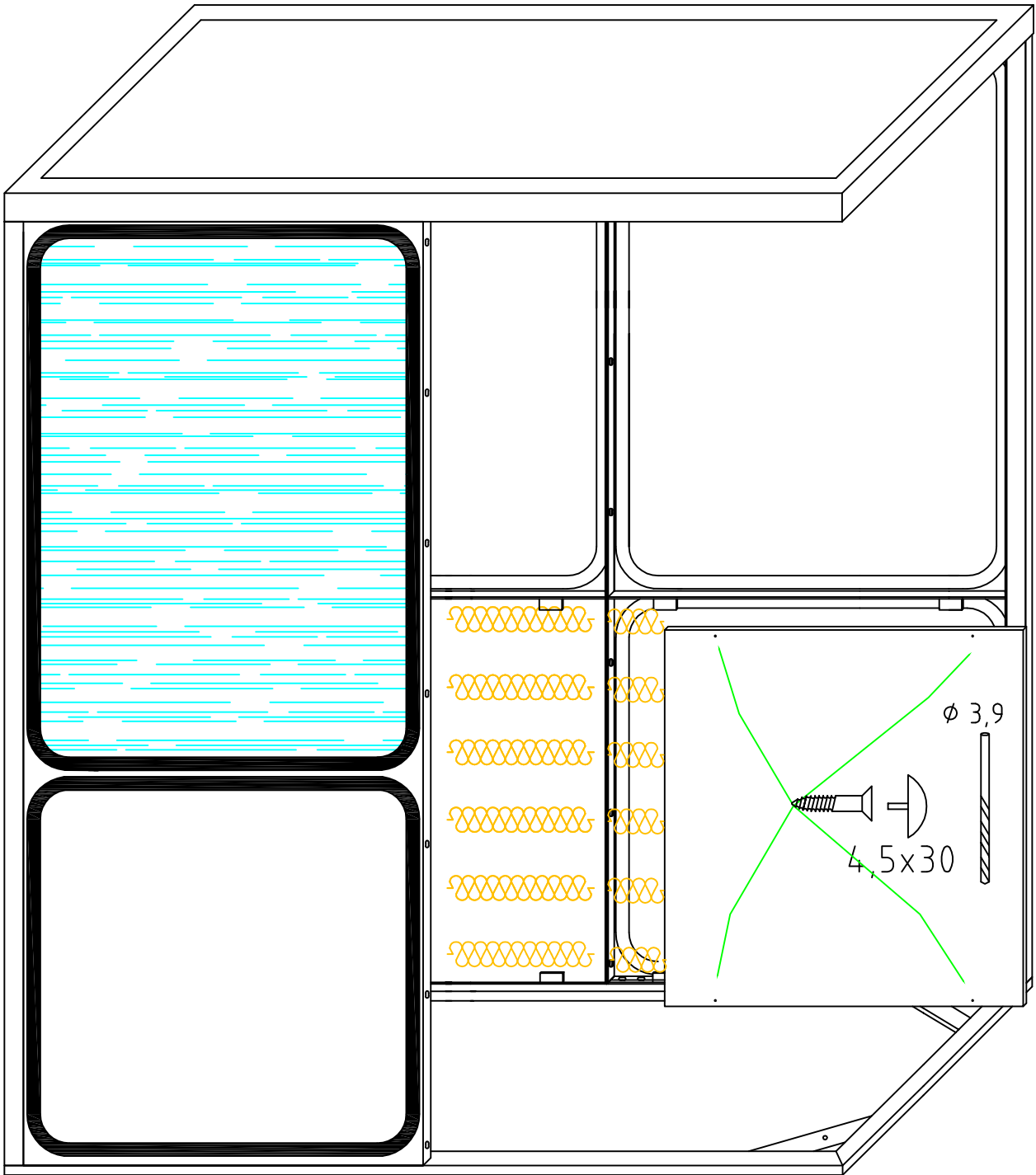

Abbildung 8.1
Fig. 8.1

Instrucciones de instalación

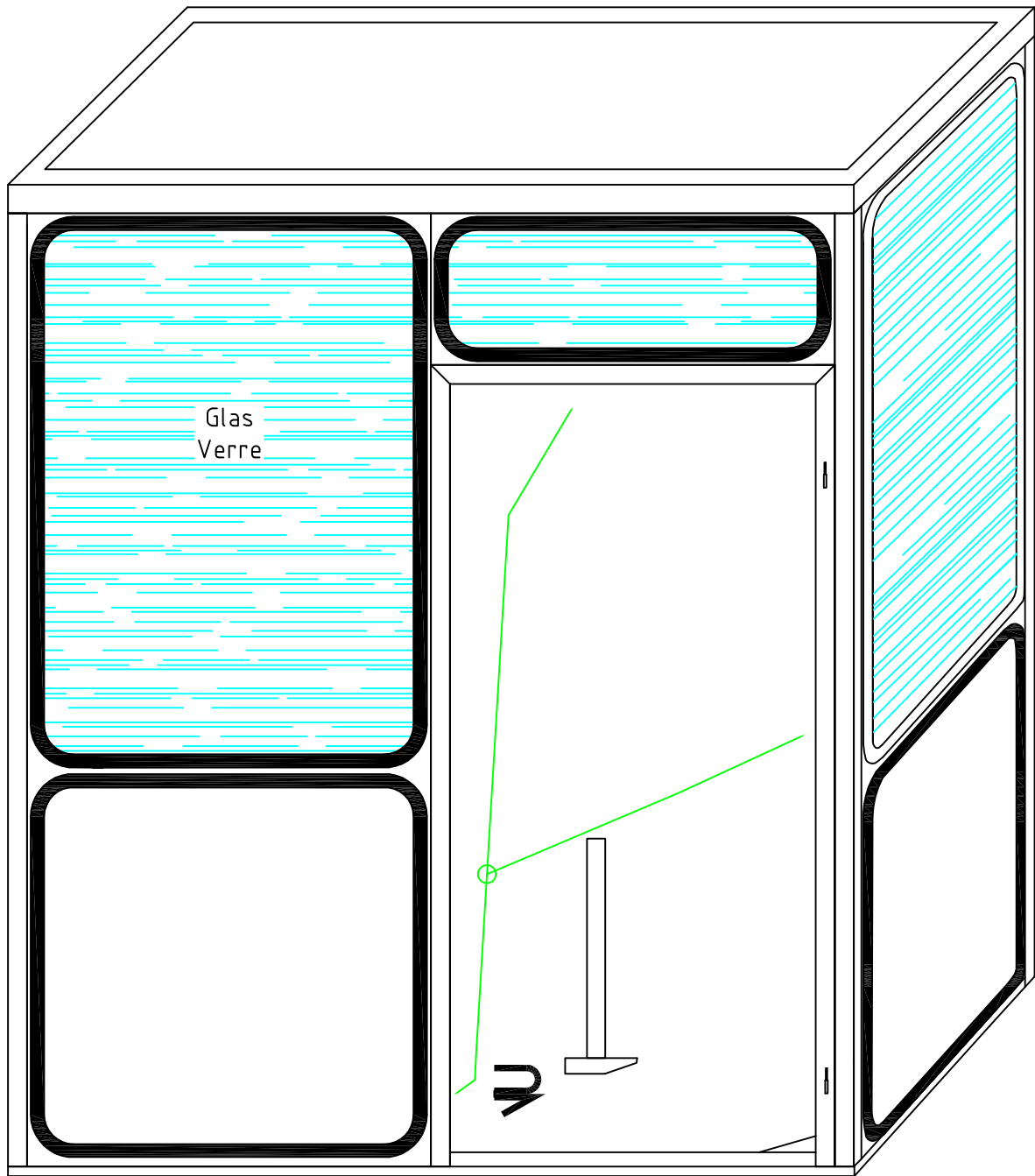
Casetas multiuso
Modelo con esquinas
redondeadas
Tipo MR

Opciones:
Suelo
Revestimiento interior

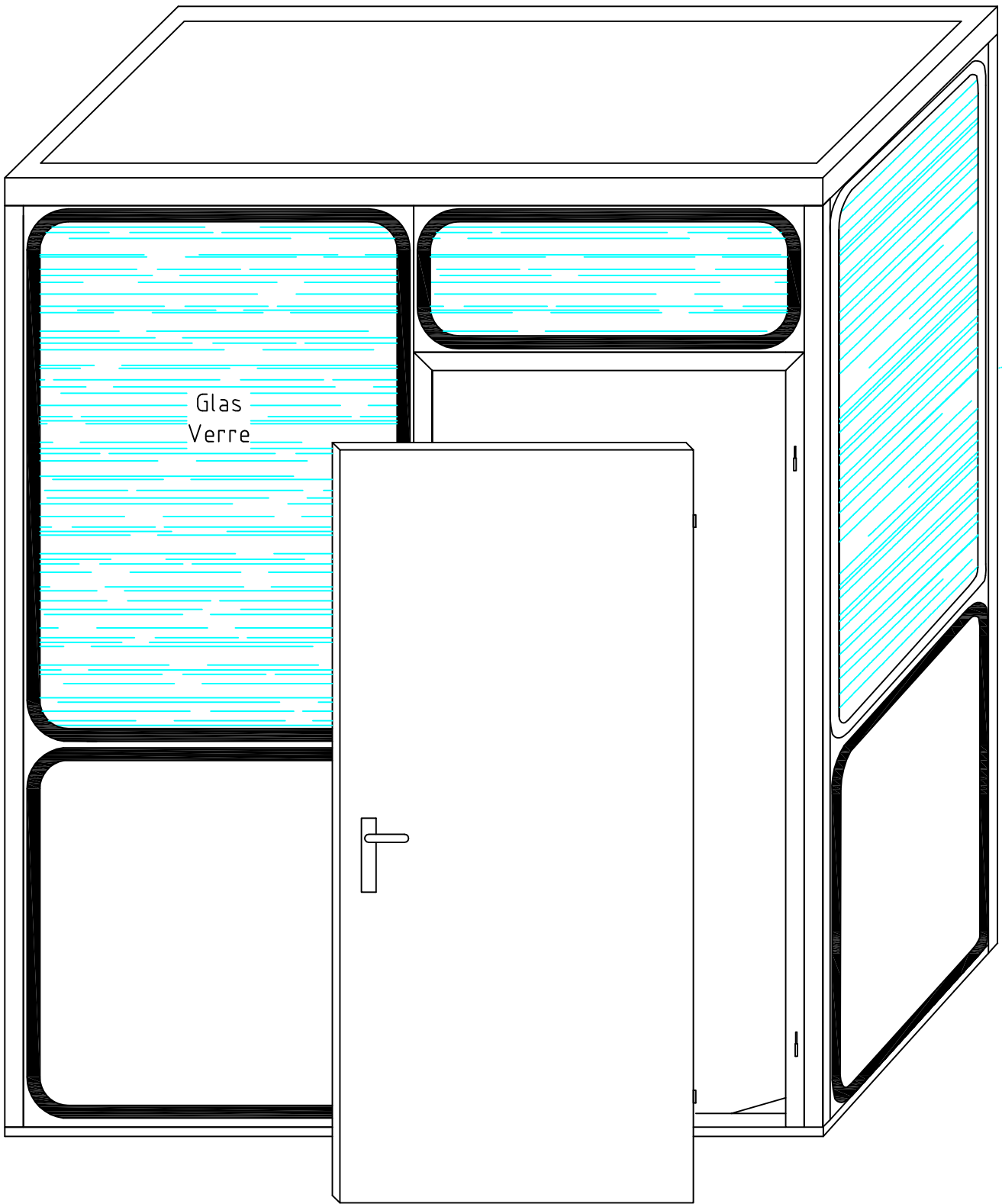
Instrucciones de instalación

Sistema de compartimientos modulares



1. Posicionar bien el marco base (Opcione de suelo o en un marco de montaje). (Fig. 1)
2. Pegar la cinta hermetizadora en el marco tubular. (Fig. 1)
3. Pegar la cinta hermetizadora en los largeros del techno. (Fig. 2)
4. Fijar los esquineros en las paredes, con los tornillos para chapa. (Fig. 2)
5. Montar en el marco base las paredes, conjuntamente con los esquineros, y atornillarlas con los tornillos para chapa. (Fig. 3)
6. Juntar las paredes, los esquineros y las puertas, luego atornillarlas. (Fig. 4.0 – 4.2)
7. Pegar la cinta hermetizadora en la parte superior de las paredes. (Fig. 5.0 – 5.1)
8. Colocar el marco del techno y atornillarlo a las paredes, utilizando los tornillos Para chapa. Modelo para colocar en interiores (Fig. 5.0) – en exteriores (Fig. 5.1)
9. Puerta de montaje. (Fig. 8.0 – 8.1)

Opcione - Revestimiento del techo

10. Colocar la lana mineral, espesor 40 mm, en el lado interior de las chapas. (Fig. 6)
11. Atornillar las planchas de virutas prensadas (espesor 13 mm) con los tornillos 4,5 x 30 mm. Meter las tapitas en los orificios de los tornillos. (Fig. 7)
12. Planta de montaje de barras.



Los cambios de disseno están reservados.



Abbildung 1
Fig. 1



Abbildung 2
Fig. 2

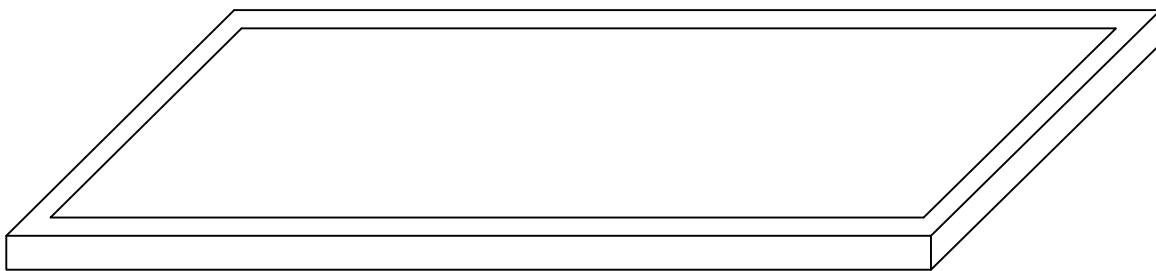
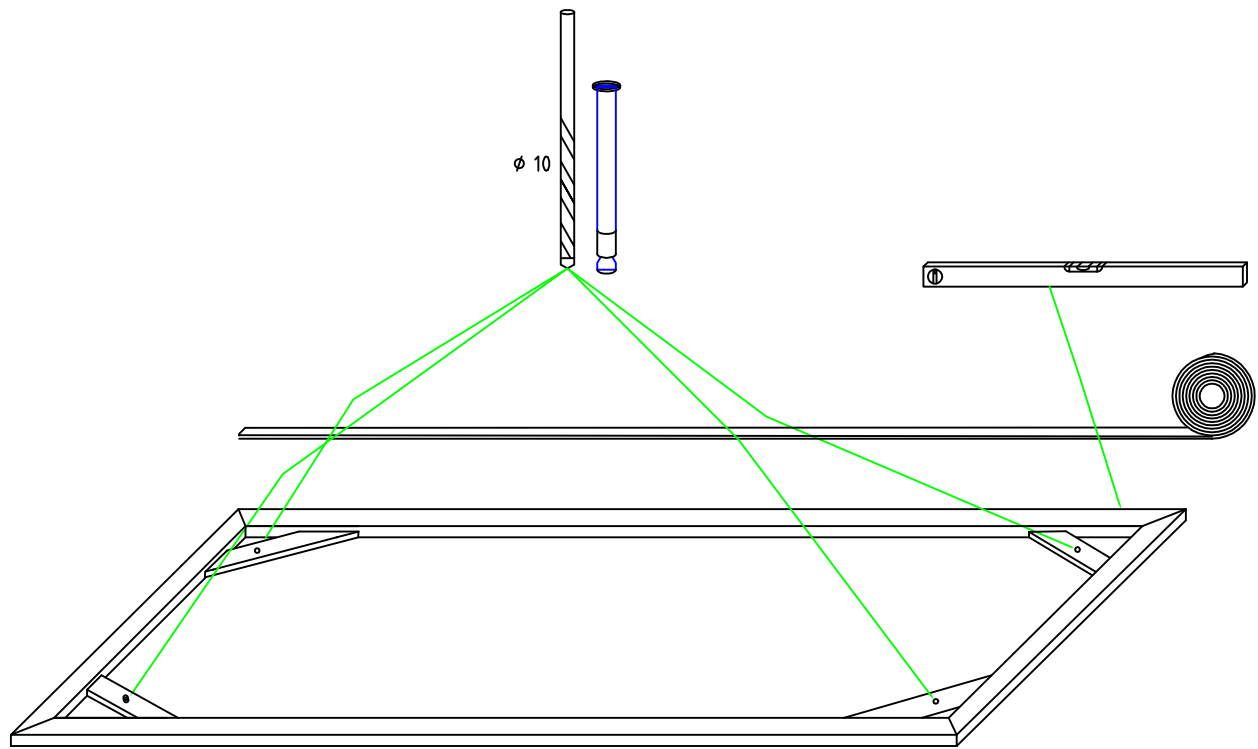

Abbildung 3
Fig. 3

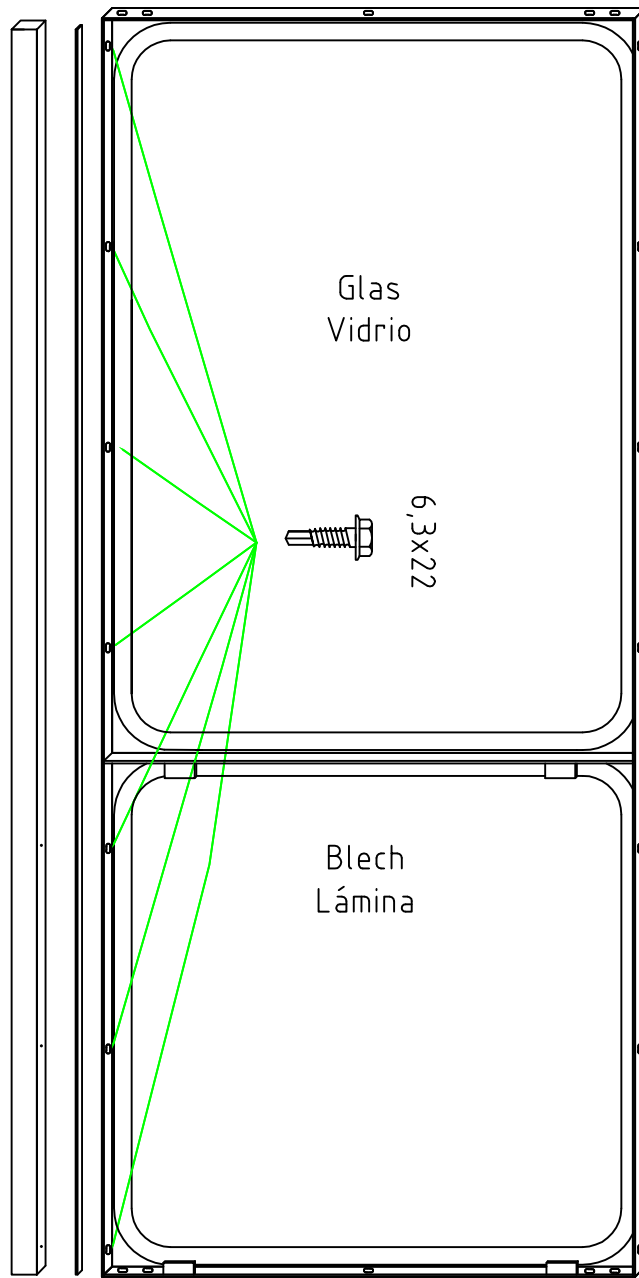

Abbildung 4.0
Fig. 4.0

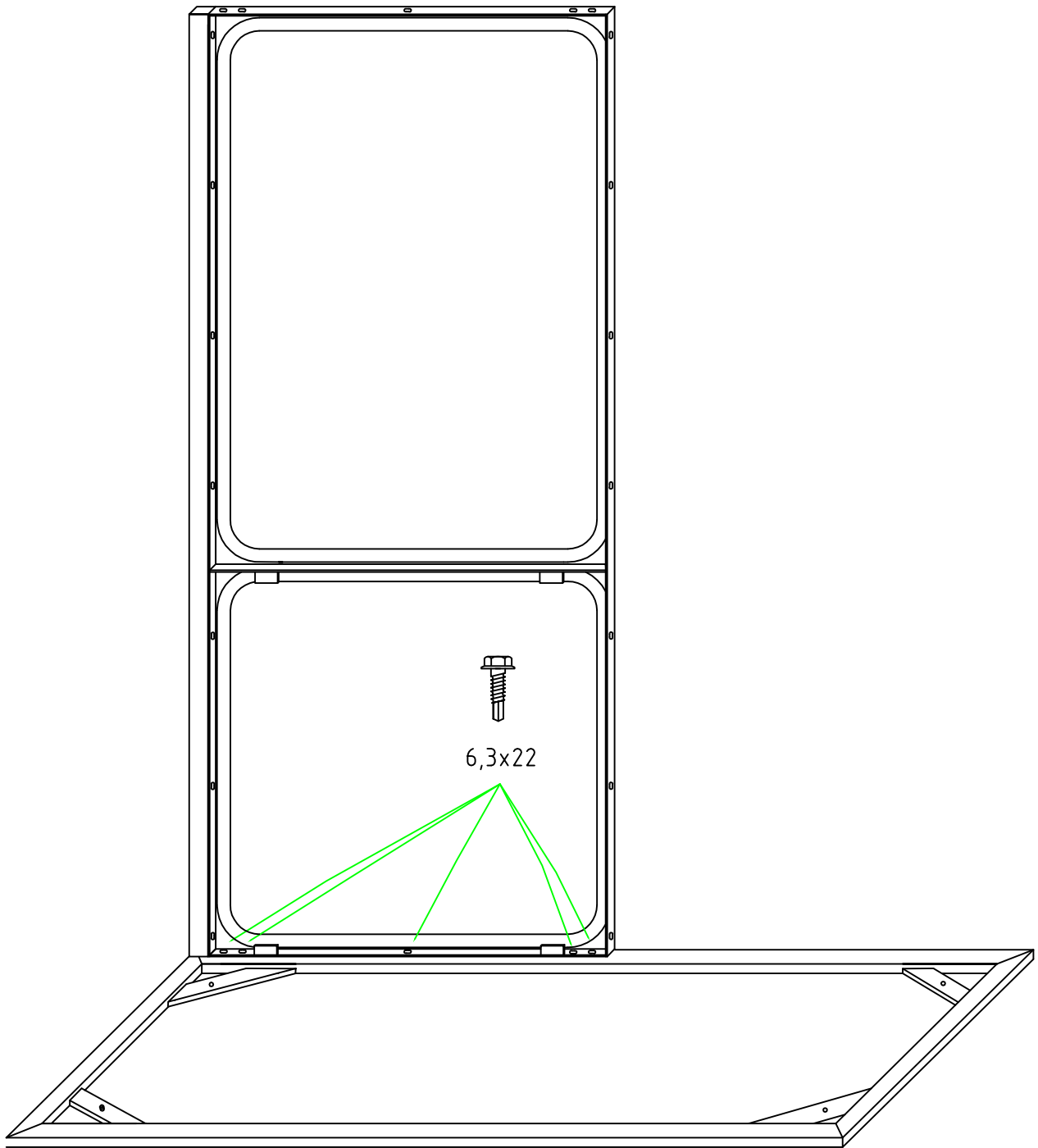

Abbildung 4.1
Fig. 4.1

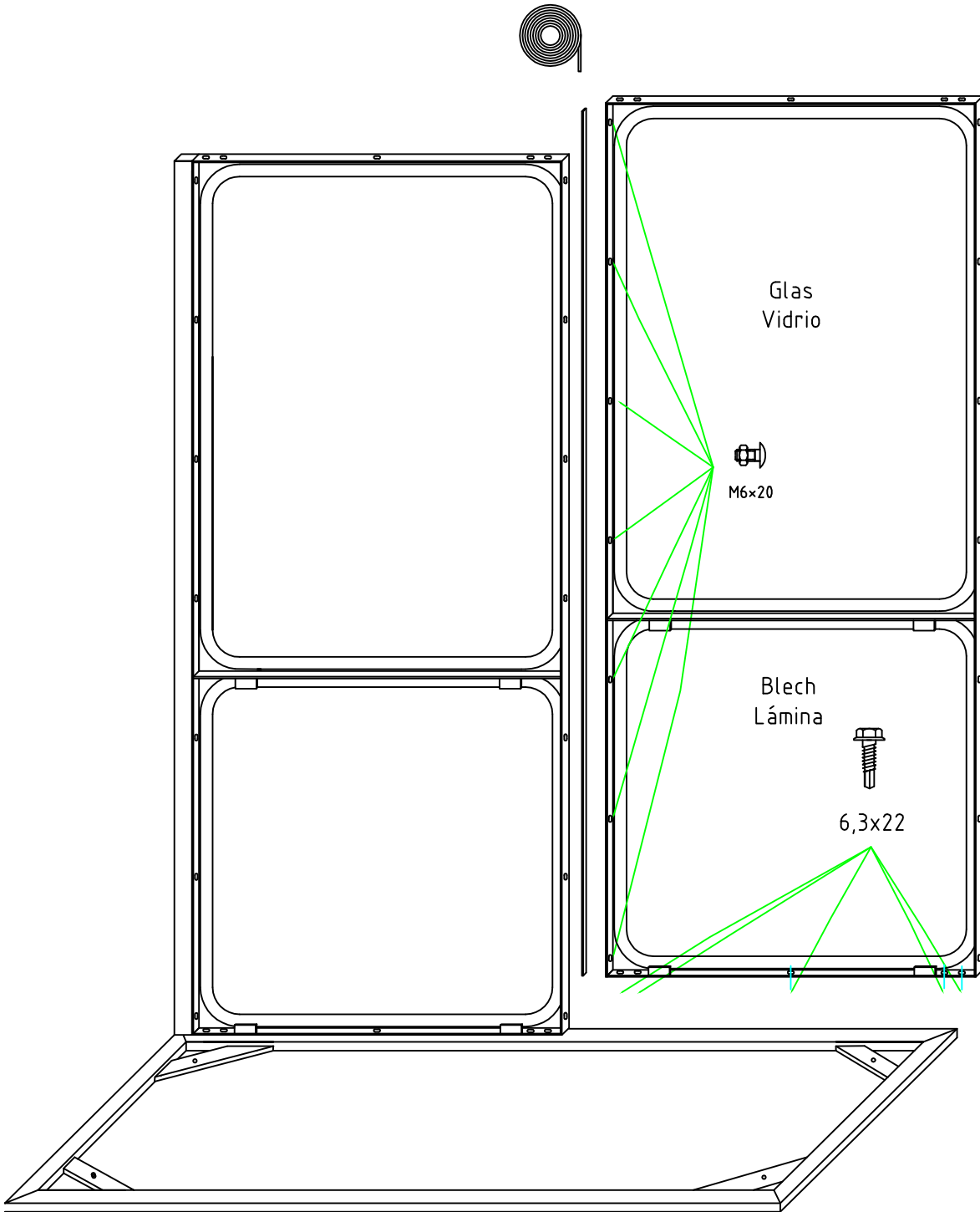

Abbildung 4.2
Fig. 4.2

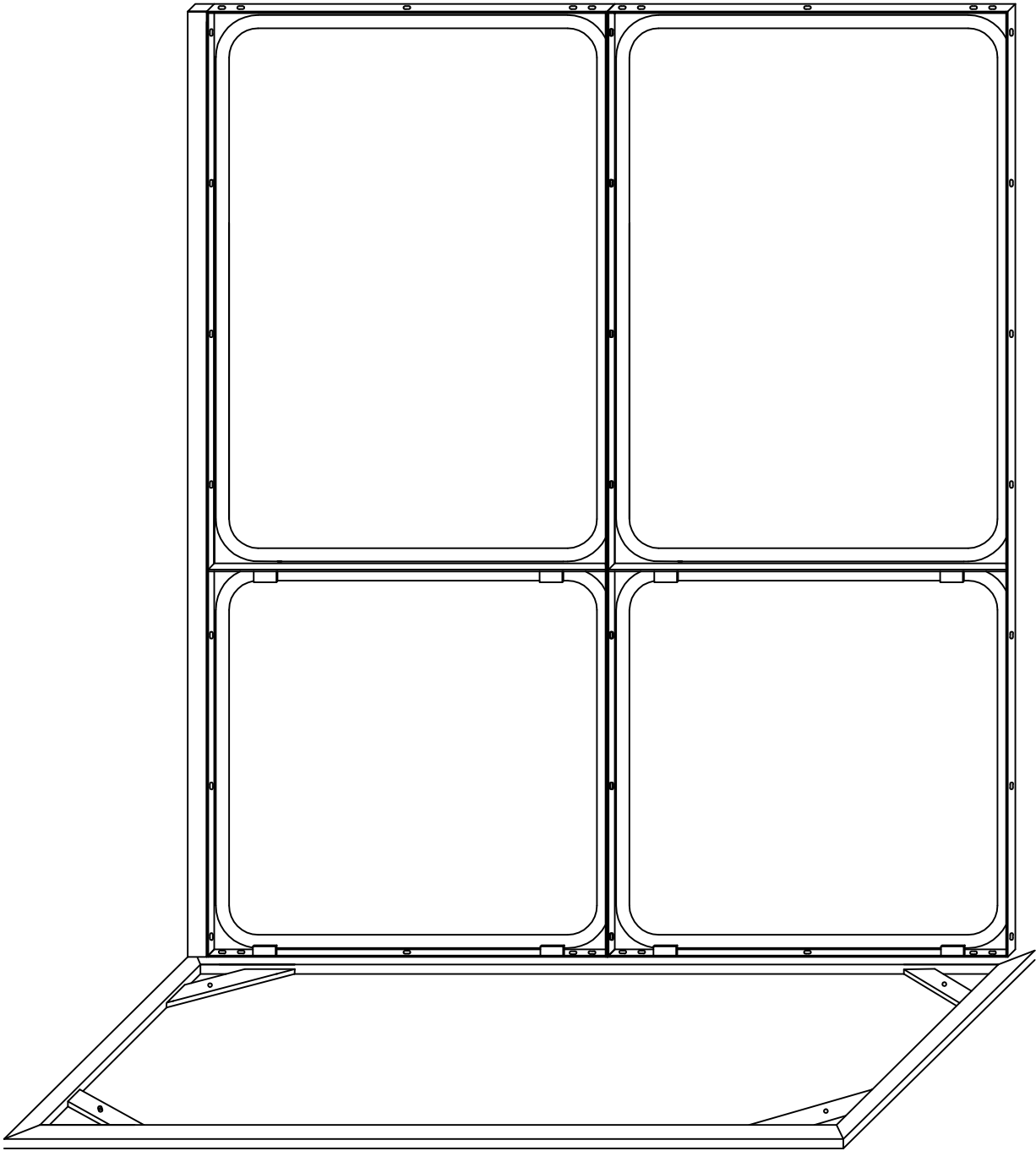

Abbildung 5.0
Fig. 5.0

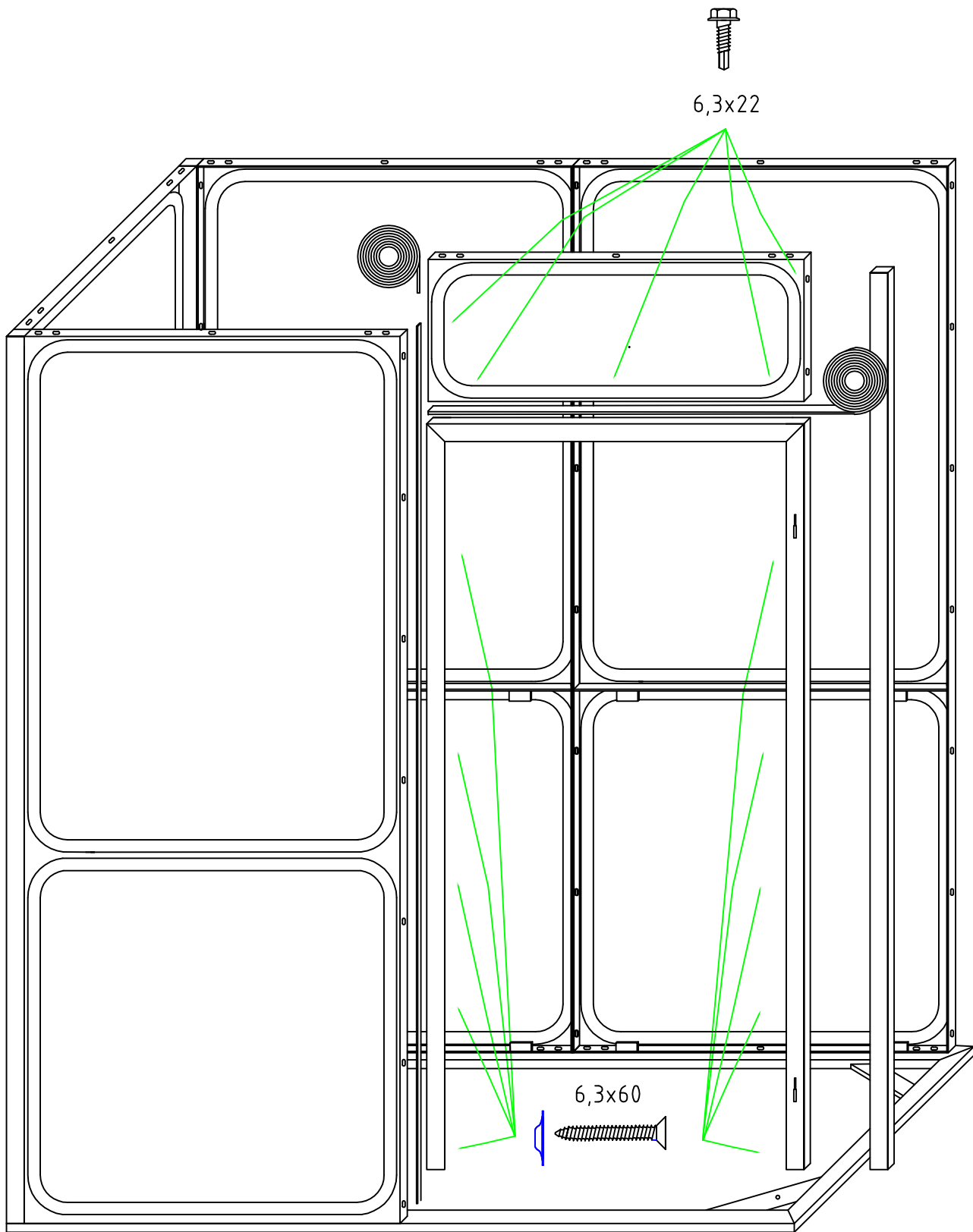

Abbildung 5.1
Fig. 5.1

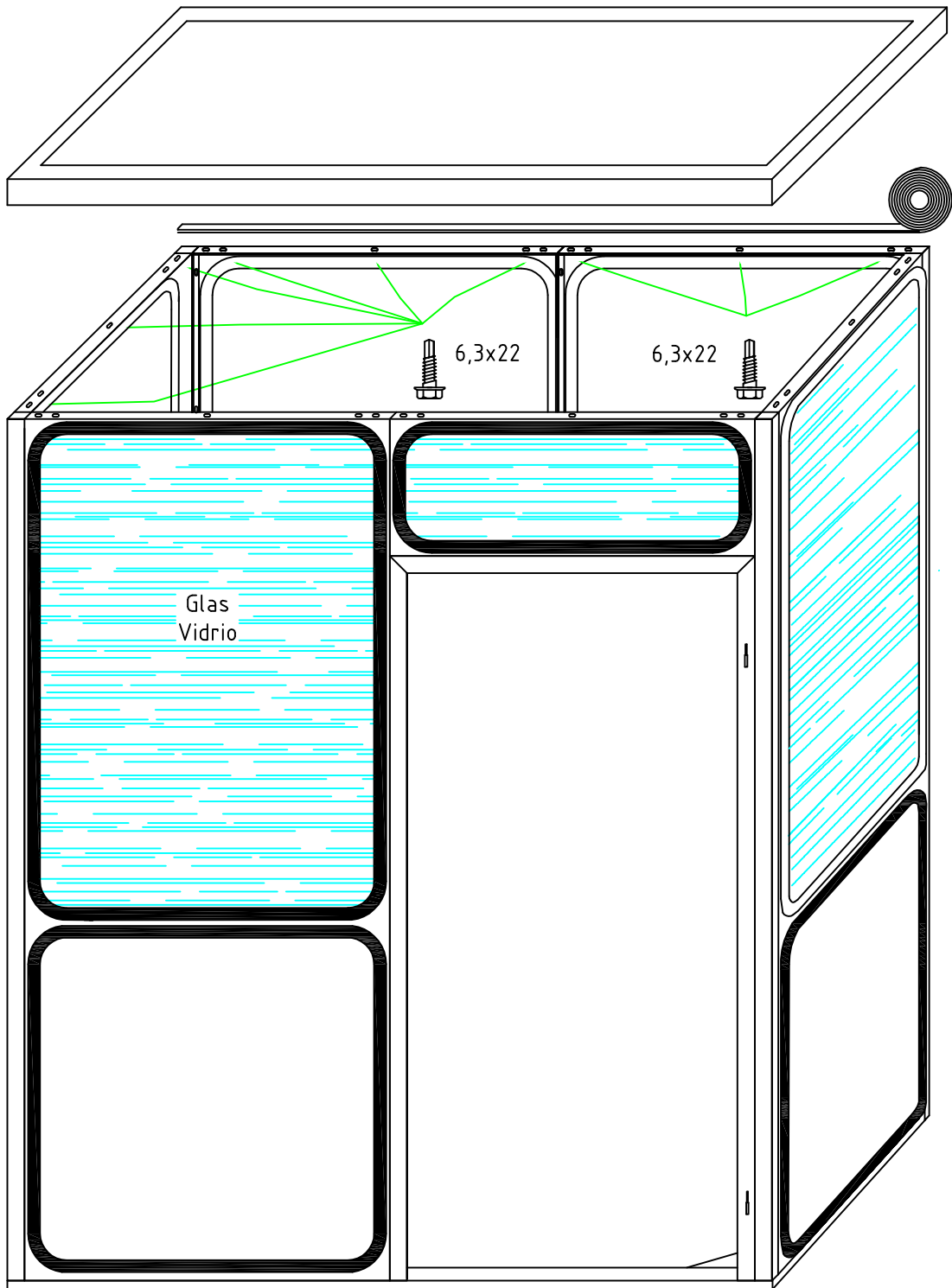

Abbildung 6
Fig. 6

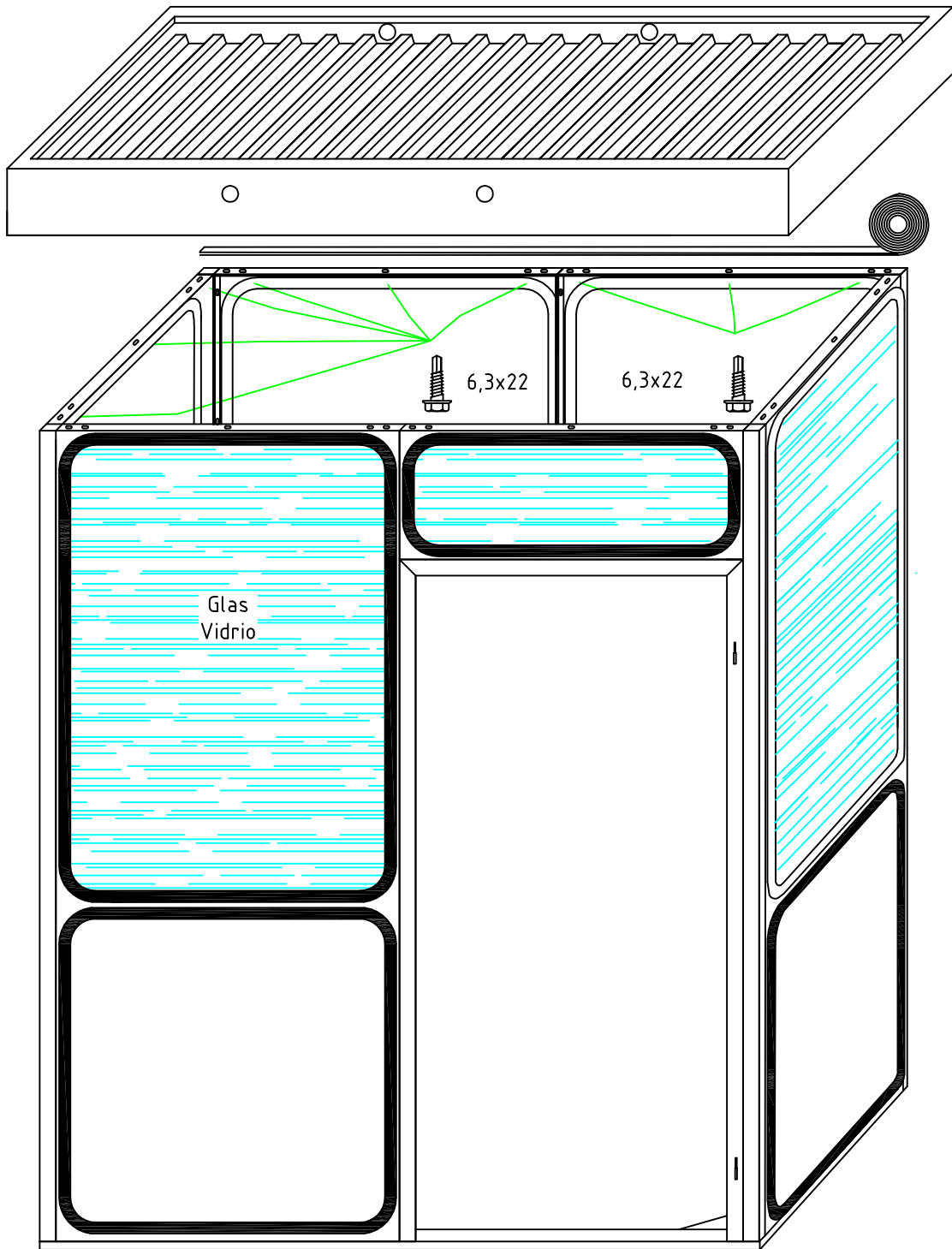

Abbildung 7
Fig. 7

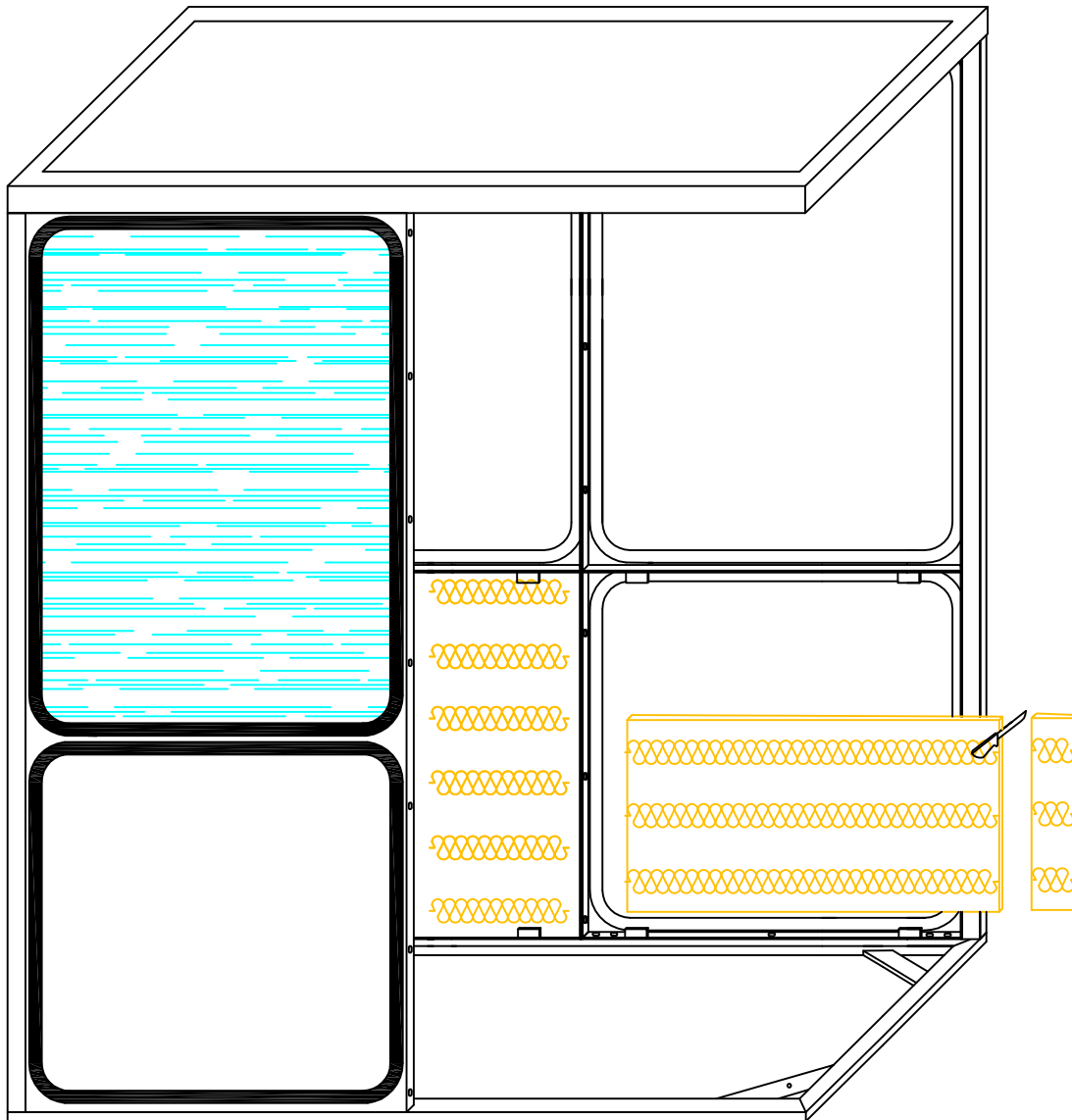

Abbildung 8.0
Fig. 8.0

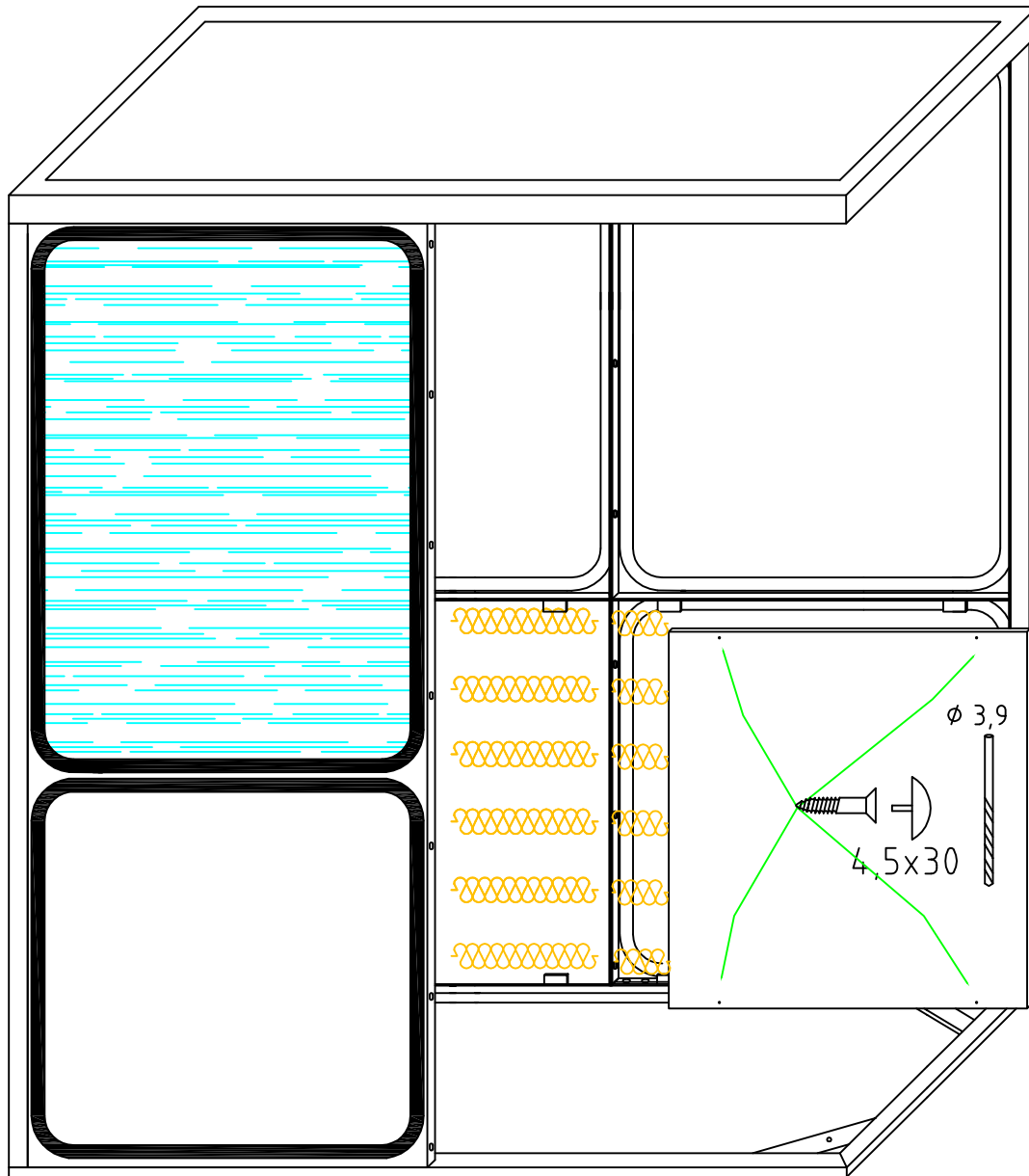

Abbildung 8.1
Fig. 8.1

Instruções de montagem

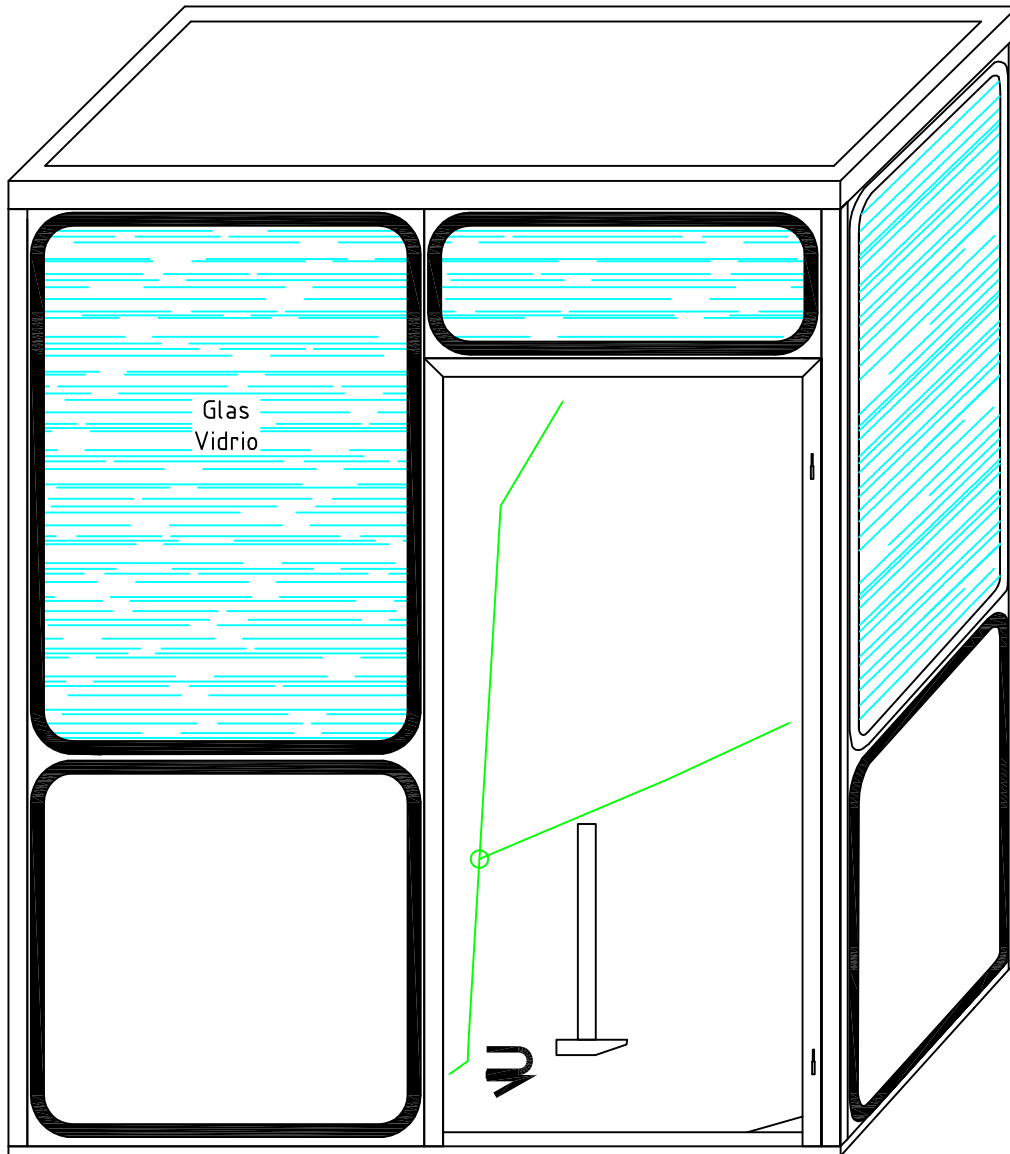
Cabines multiusos

Versão de cantos

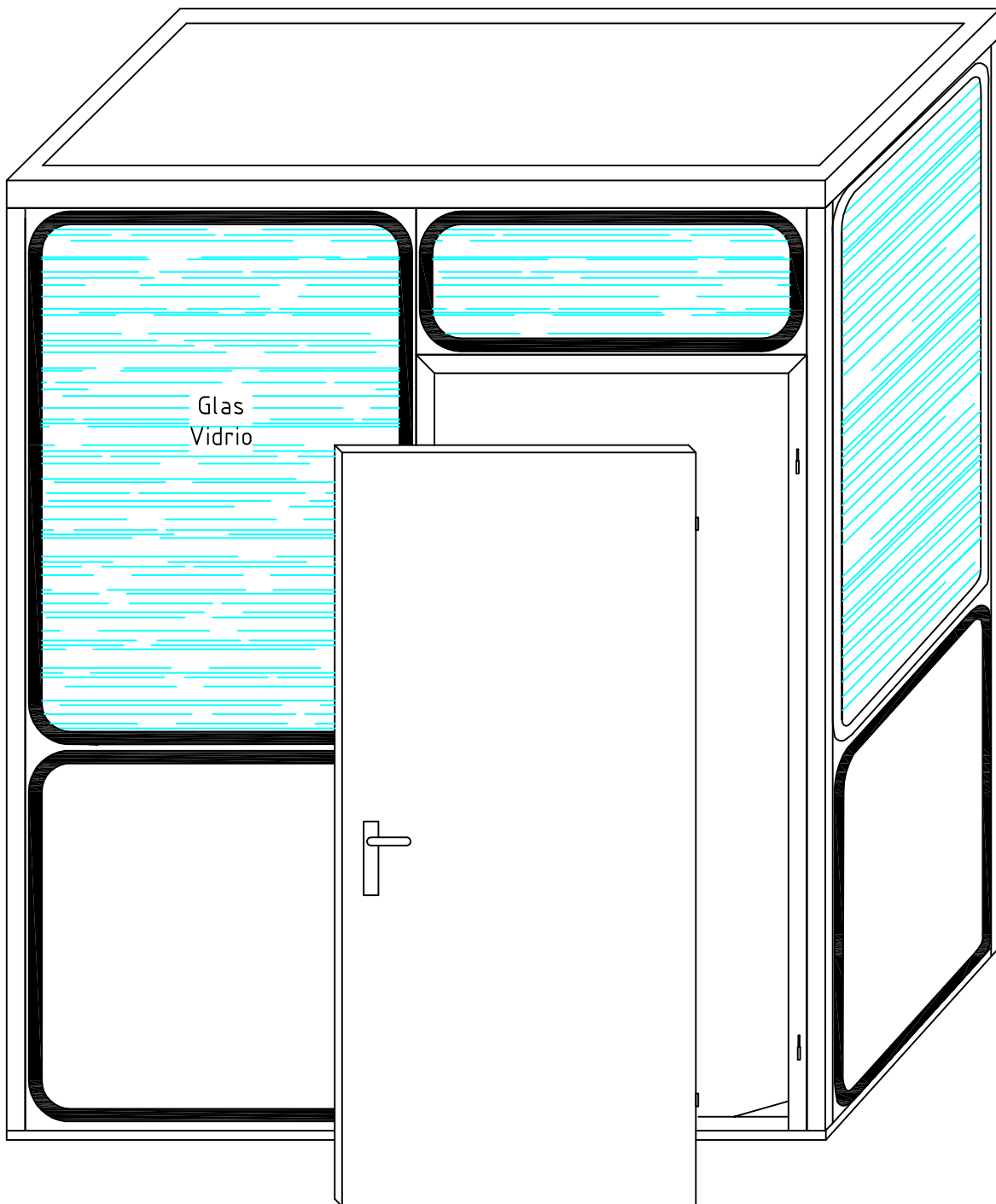
redondos

Tipo MR

Opções:

Chão

Revestimento interior

Instruções de montagem

Sistema modular de recinto



1. Alinhar a armação de fundamento (Opção de chão ou armação de montagem). (Fig. 1)
2. Colar a fita de vedação na armação tubular. (Fig. 1)
3. Colar a fita de vedação nos lados longitudinais dos elementos de teto. (Fig. 2)
4. Aparafusar montante de canto ao painel de parede, mediante parafusos para chapa. (Fig. 2)
5. Colocar painel de parede com o montante de canto na armação de fundamento e Fixá-lo por meio dos parafusos para chapa. (Fig. 3)
6. Colocar juntos os painéis de parede, montantes de canto e portas e aparafusá-los. (Fig. 4.0 – 4.2)
7. Colar a fita de vedação na parte superior do painéis de parede.(Fig. 5.0 – 5.1)
8. Colocar a armação de teto e aparafusá-la com os painéis de parede. Utilizar parafusos para chapa.
Versão para colocação em interiores (Fig. 5.0) – em exteriores (Fig. 5.1)
9. Montagem porta(s). (Fig. 8.0 – 8.1)

Opção - Revestimento interior

10. Aplicar a lã mineral de 40 mm de dentro às placas de chapa. (Fig. 6)
11. Aparafusar placa de aglomerado de madeira de 13 mm mediante parafuso de cabeça embutida 4,5 x 30 mm. Colocar as capas introduzindo-as nos furos existentes nas cabeças dos parafusos. (Fig. 7)
12. Fixar o rodapé com pregos.



Alterações de design são reservados.



Abbildung 1
Fig. 1



Abbildung 2
Fig. 2

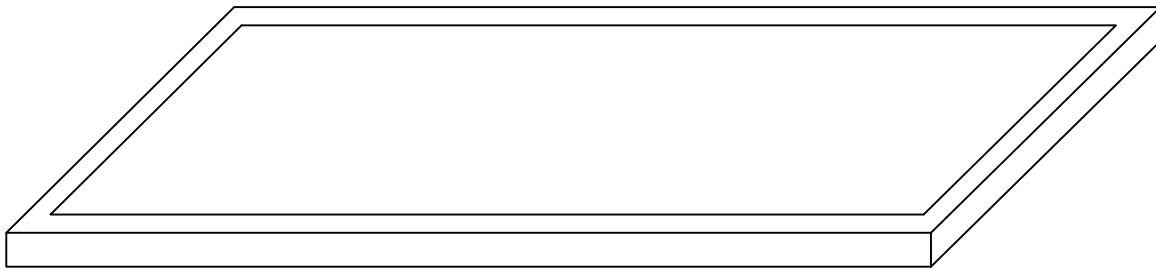
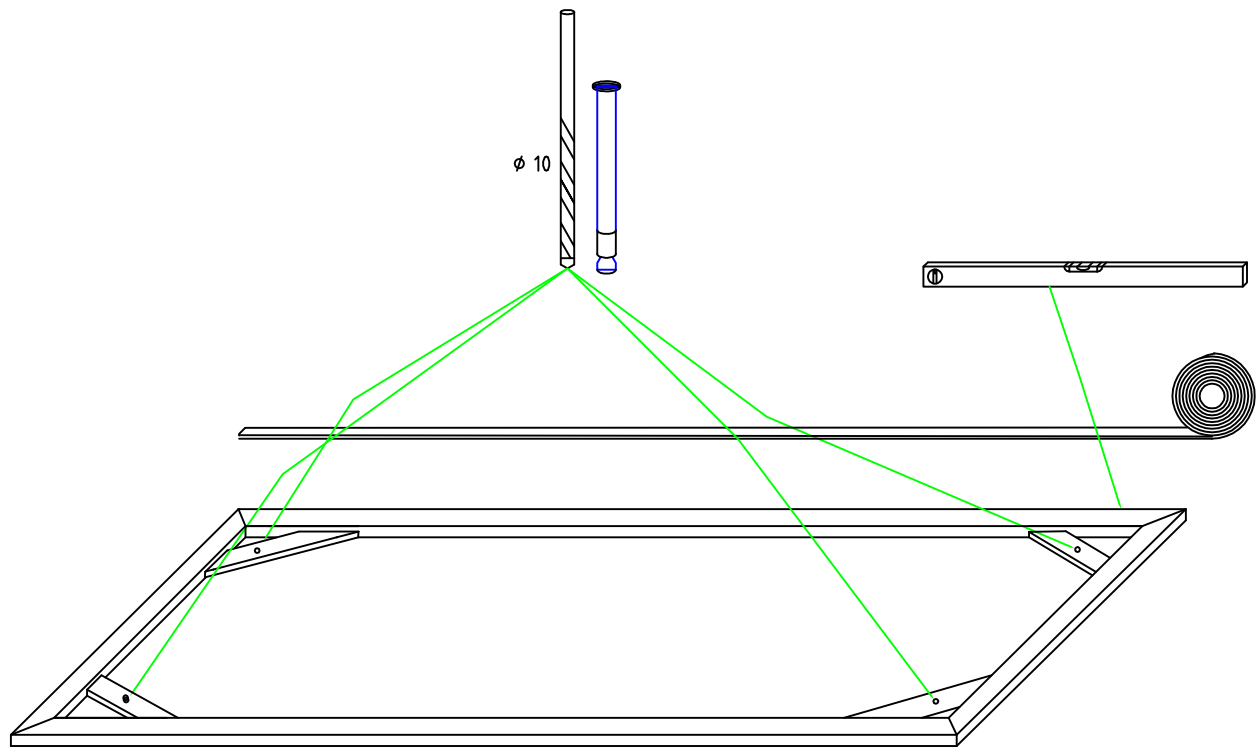

Abbildung 3
Fig. 3

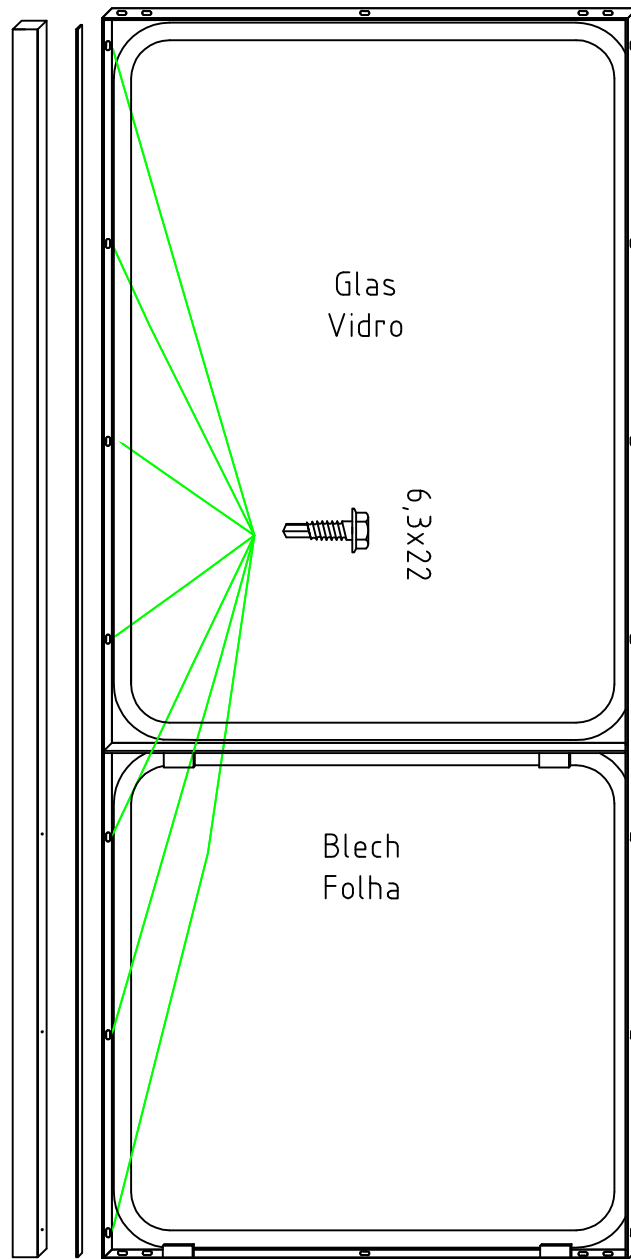

Abbildung 4.0
Fig. 4.0

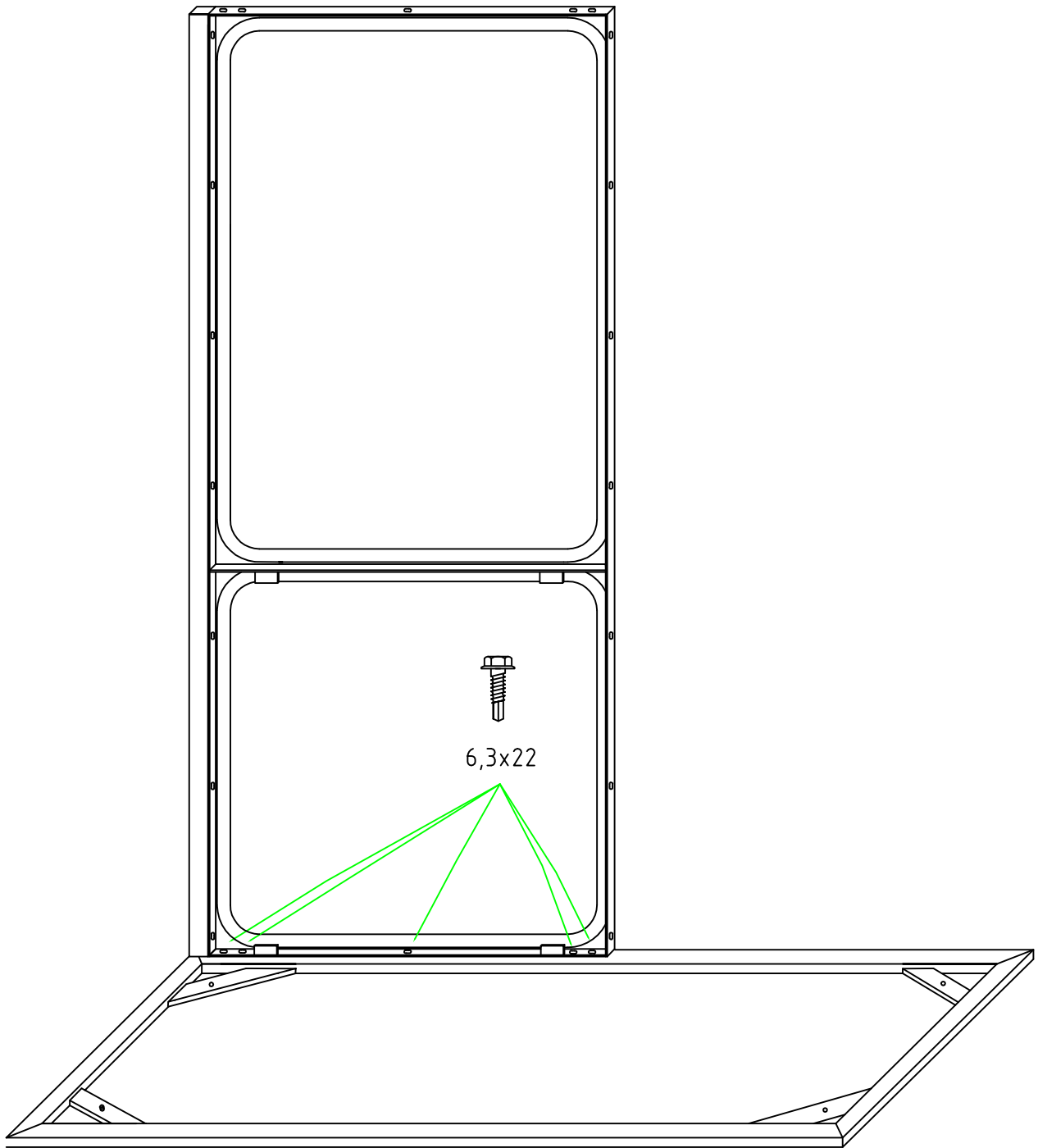

Abbildung 4.1
Fig. 4.1

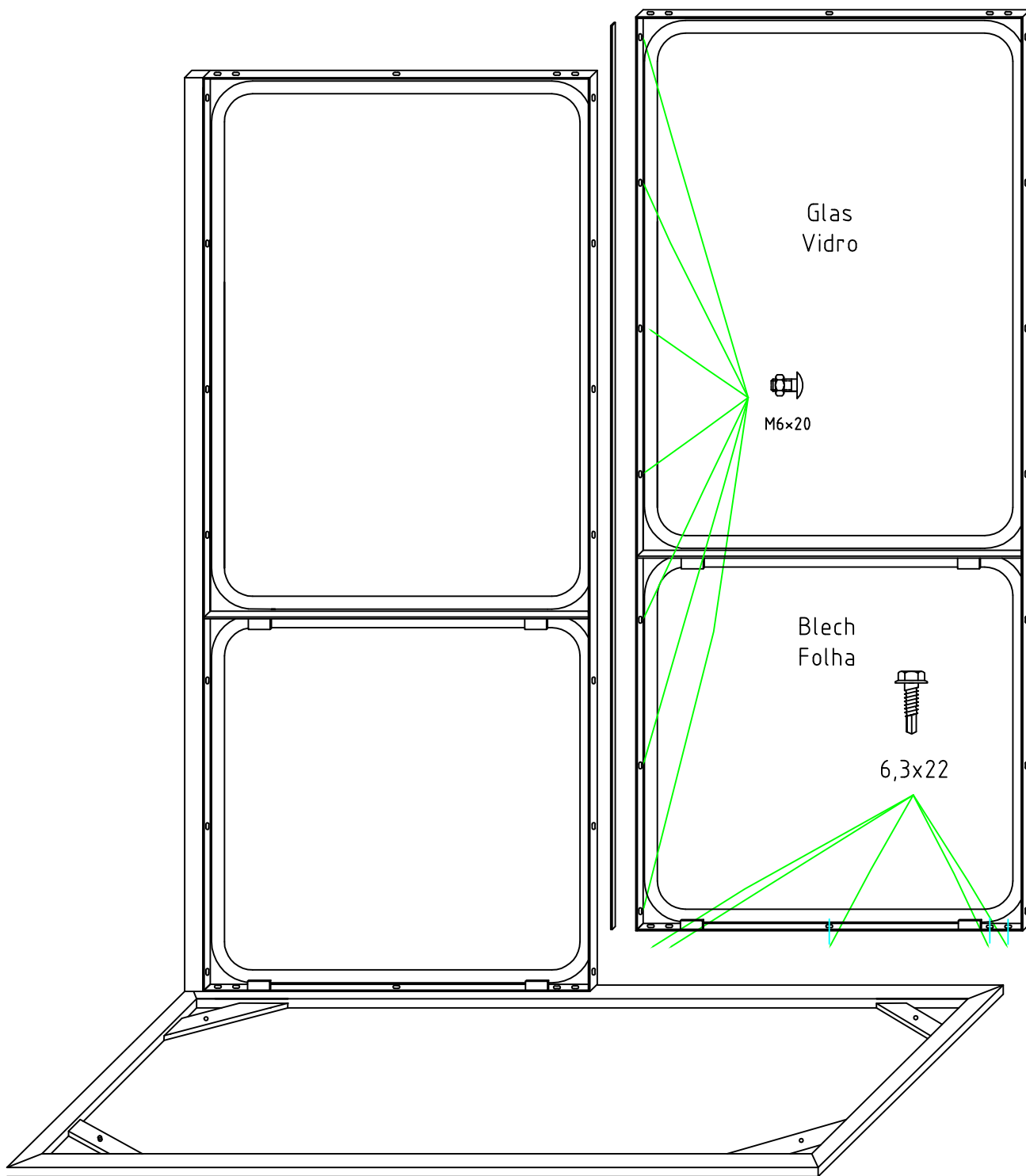

Abbildung 4.2
Fig. 4.2

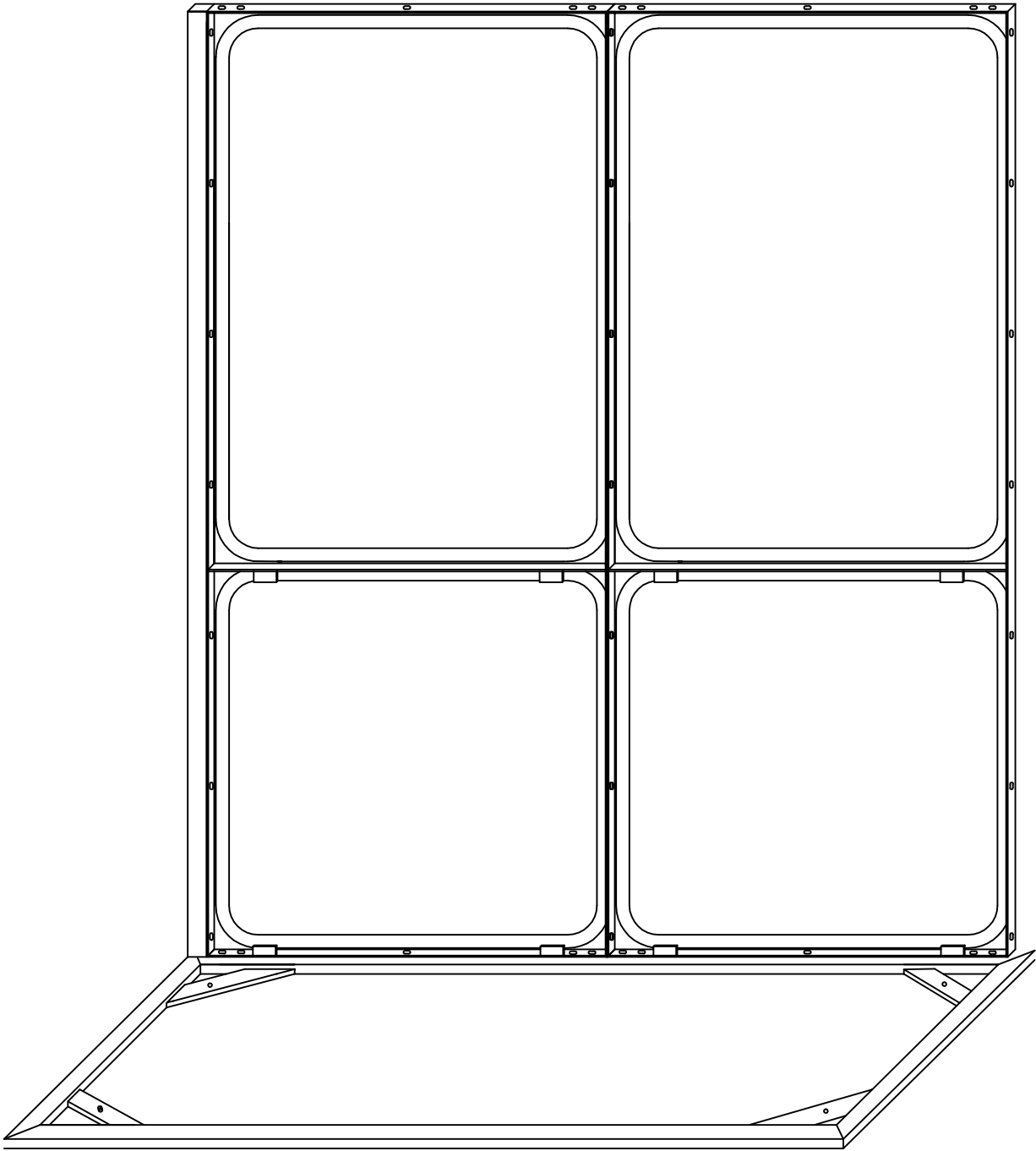

Abbildung 5.0
Fig. 5.0

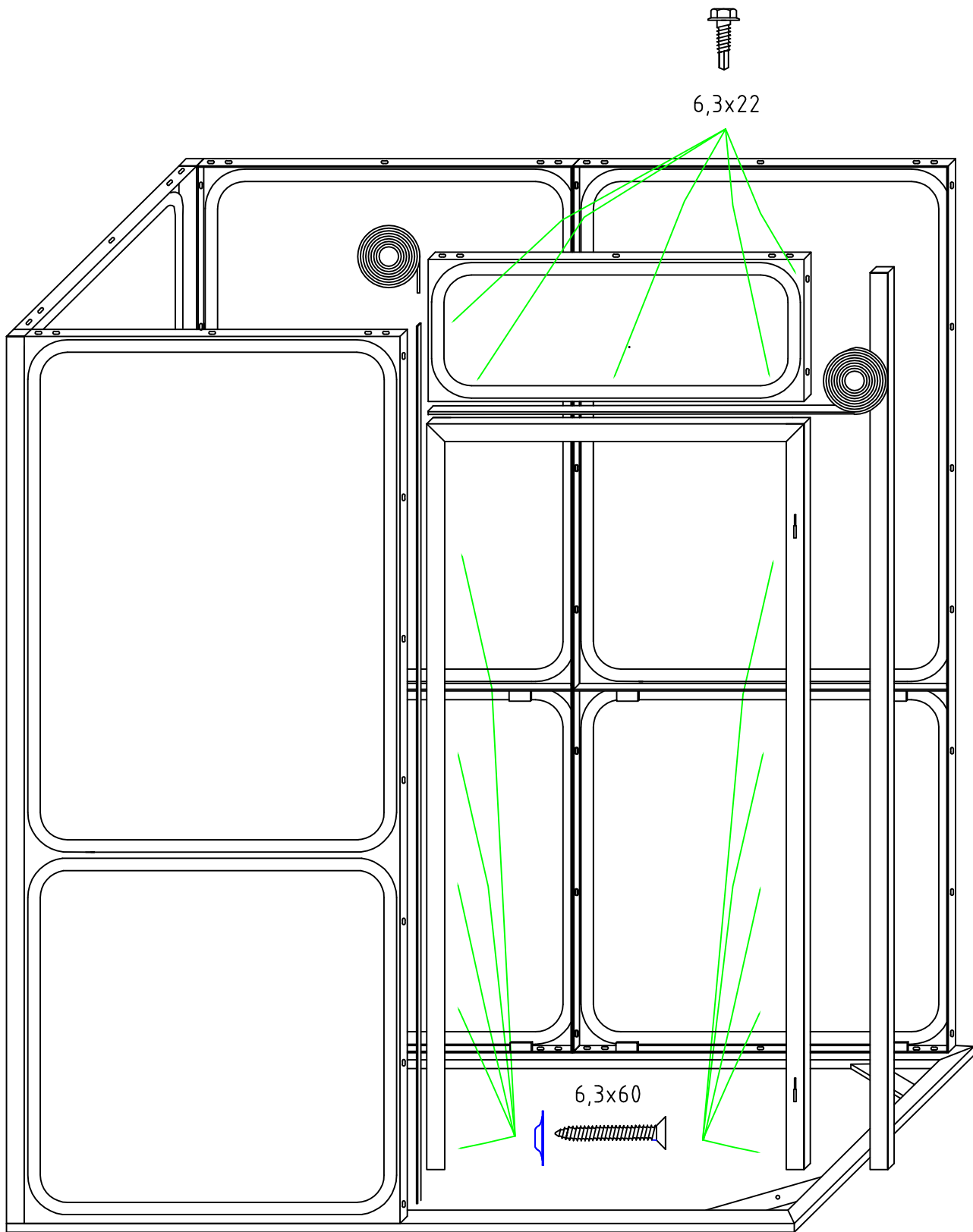

Abbildung 5.1
Fig. 5.1

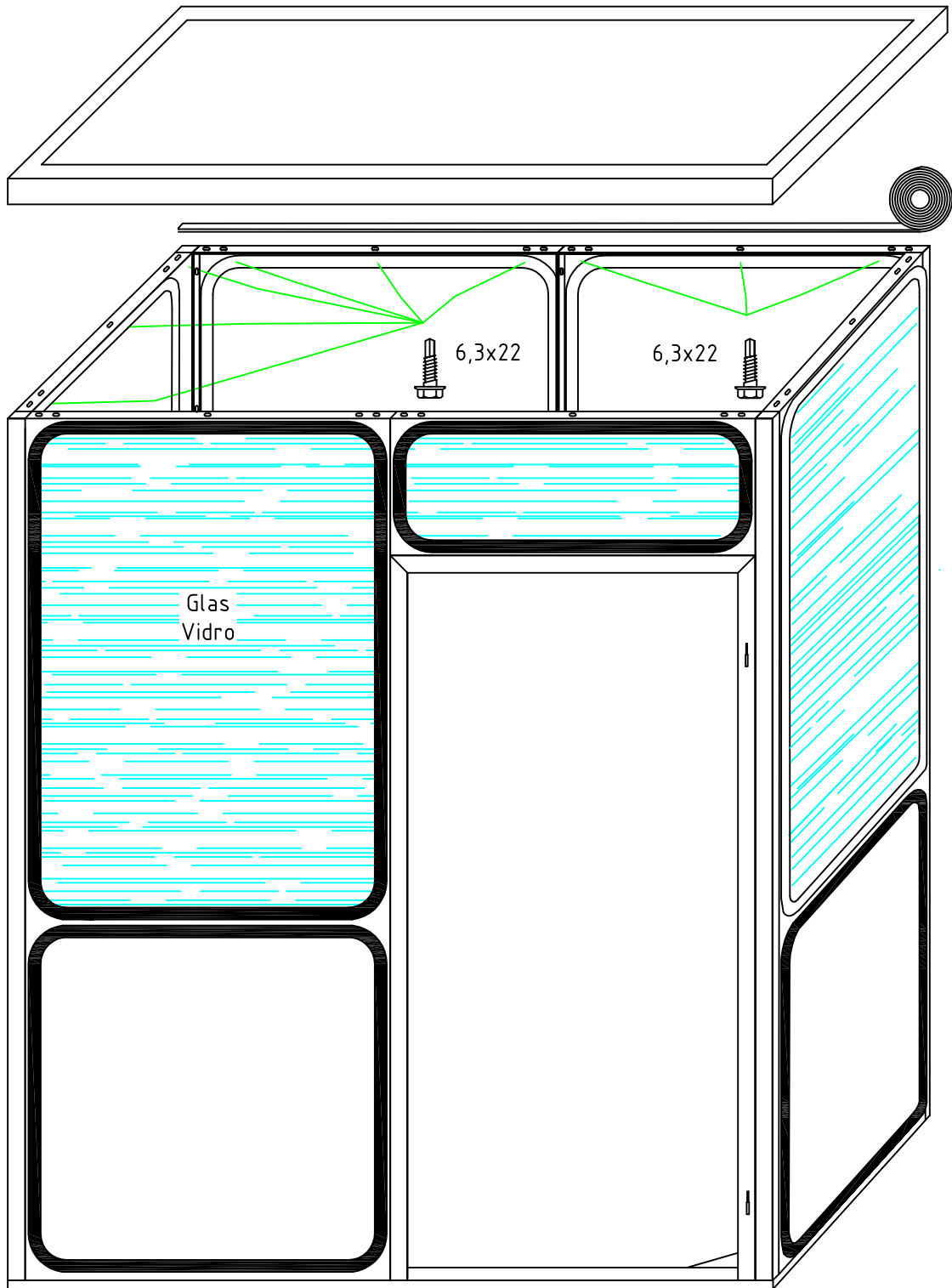

Abbildung 6
Fig. 6

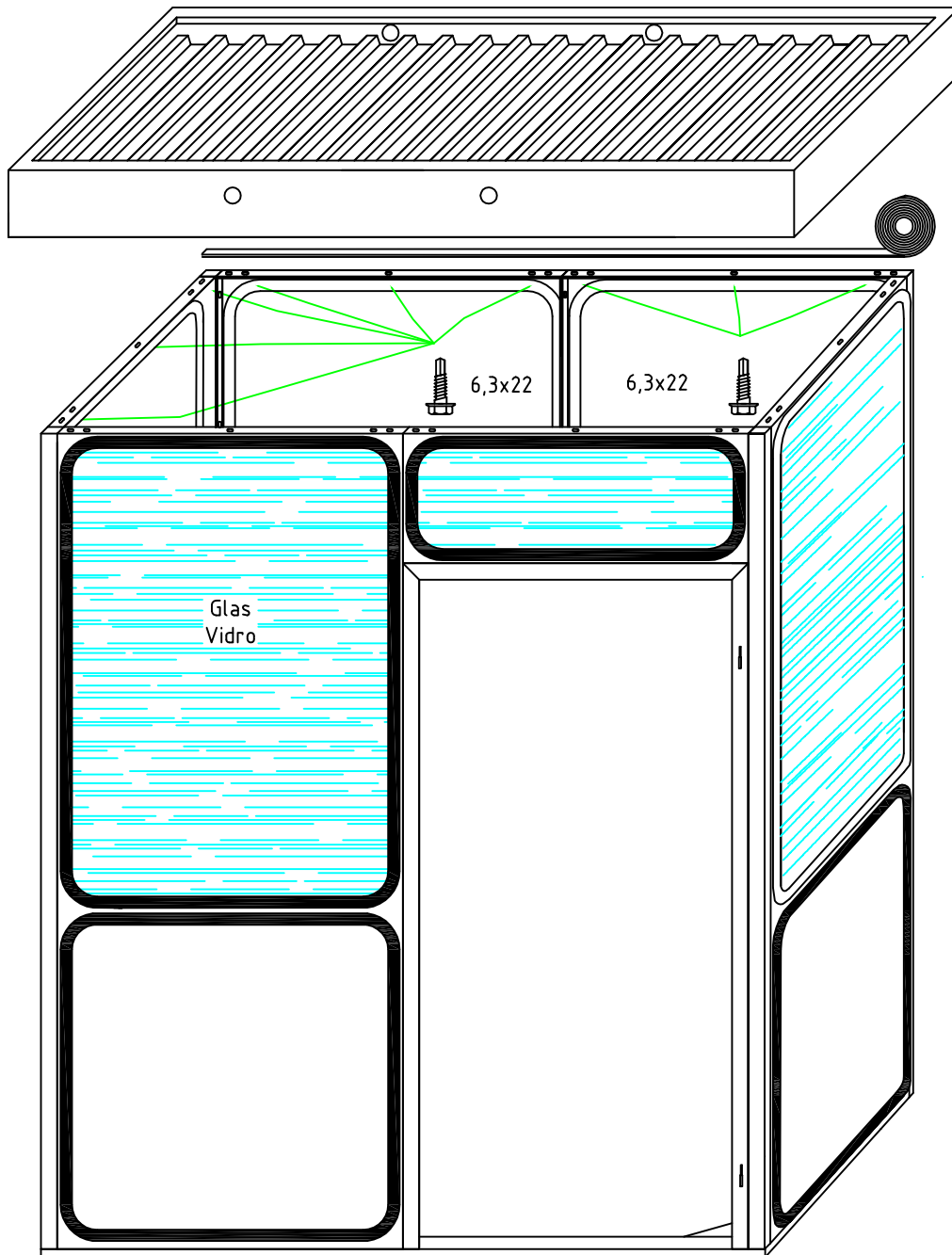

Abbildung 7
Fig. 7

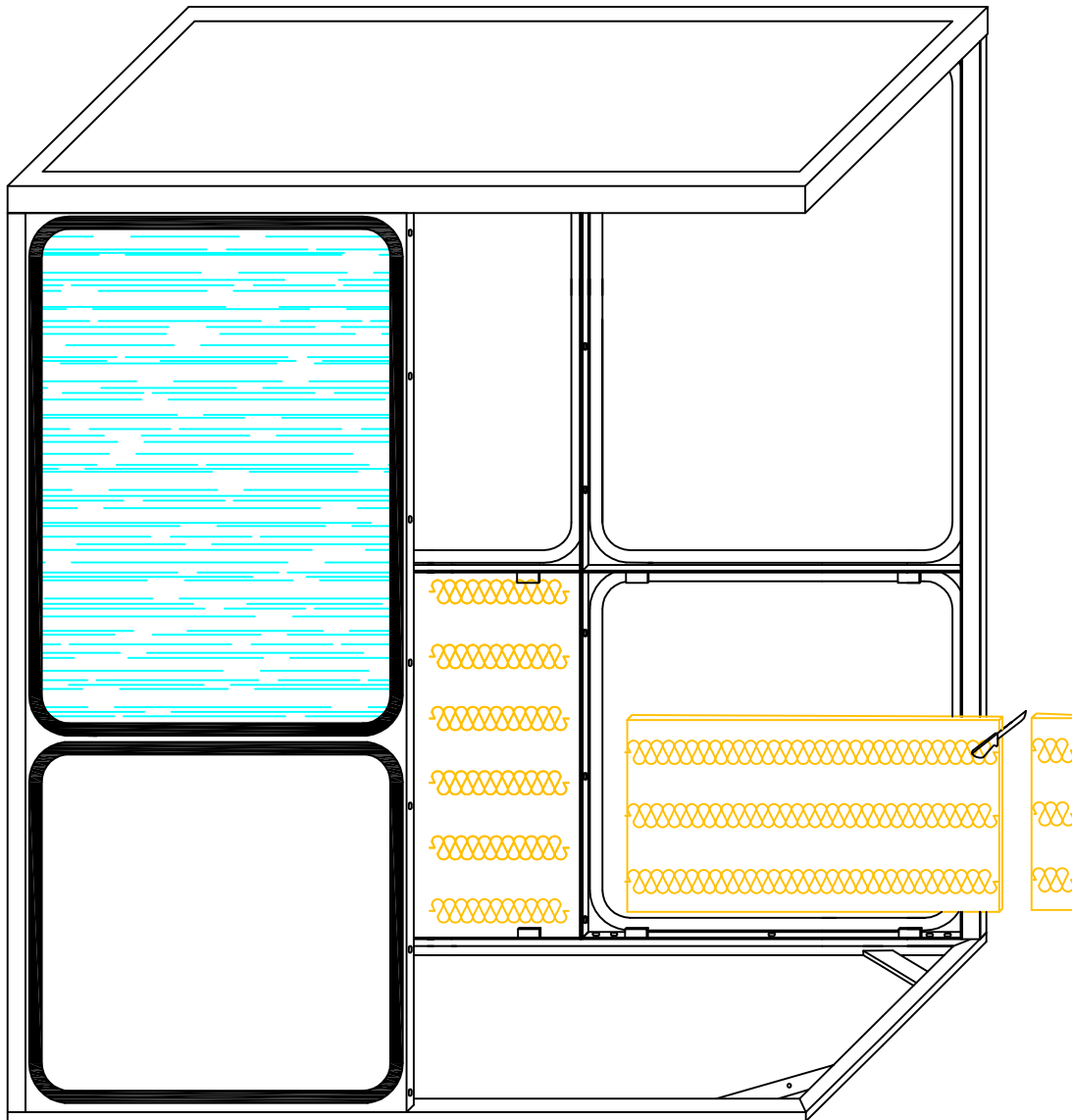

Abbildung 8.0
Fig. 8.0

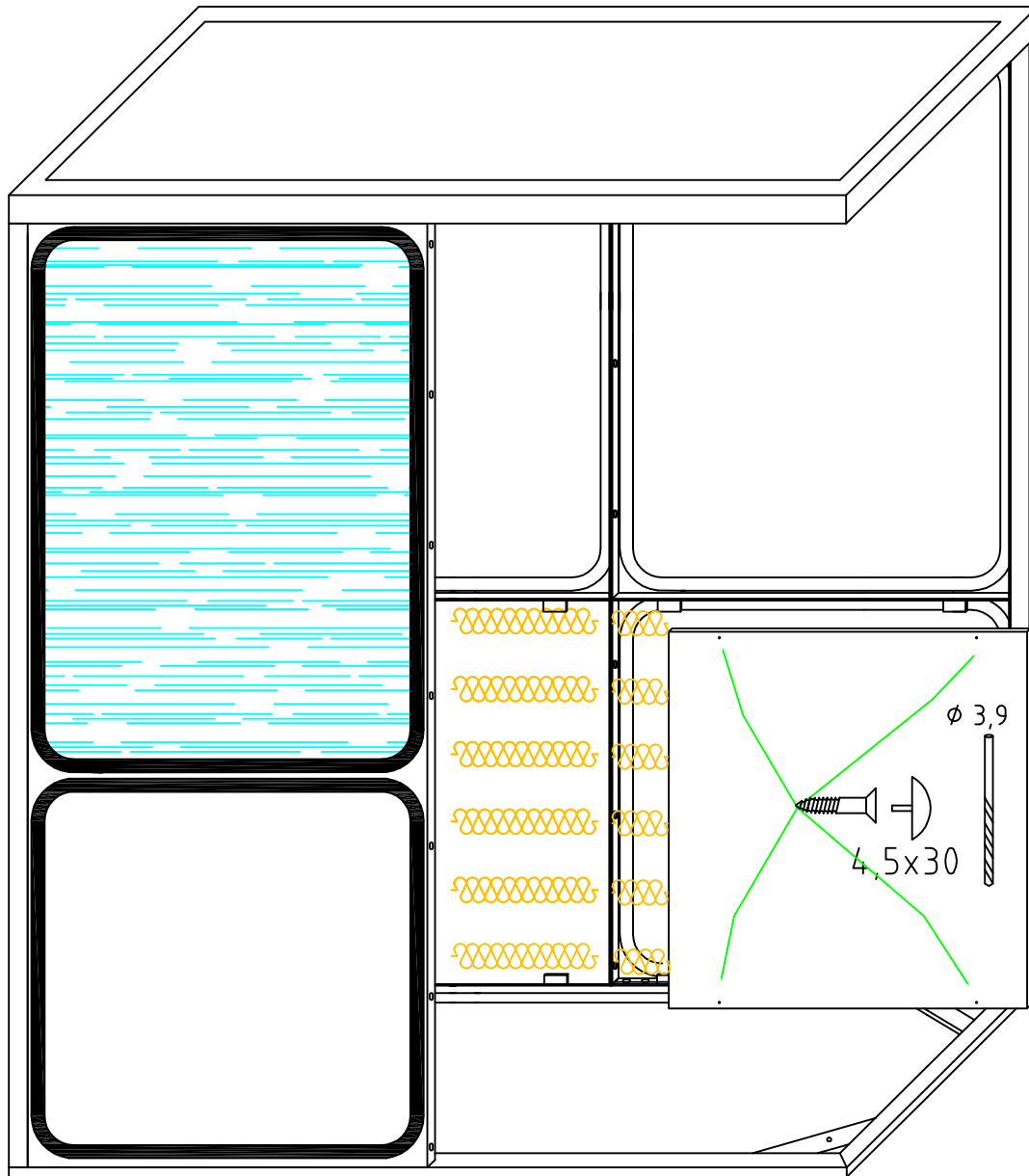

Glas
Vidro

Abbildung 8.1
Fig. 8.1

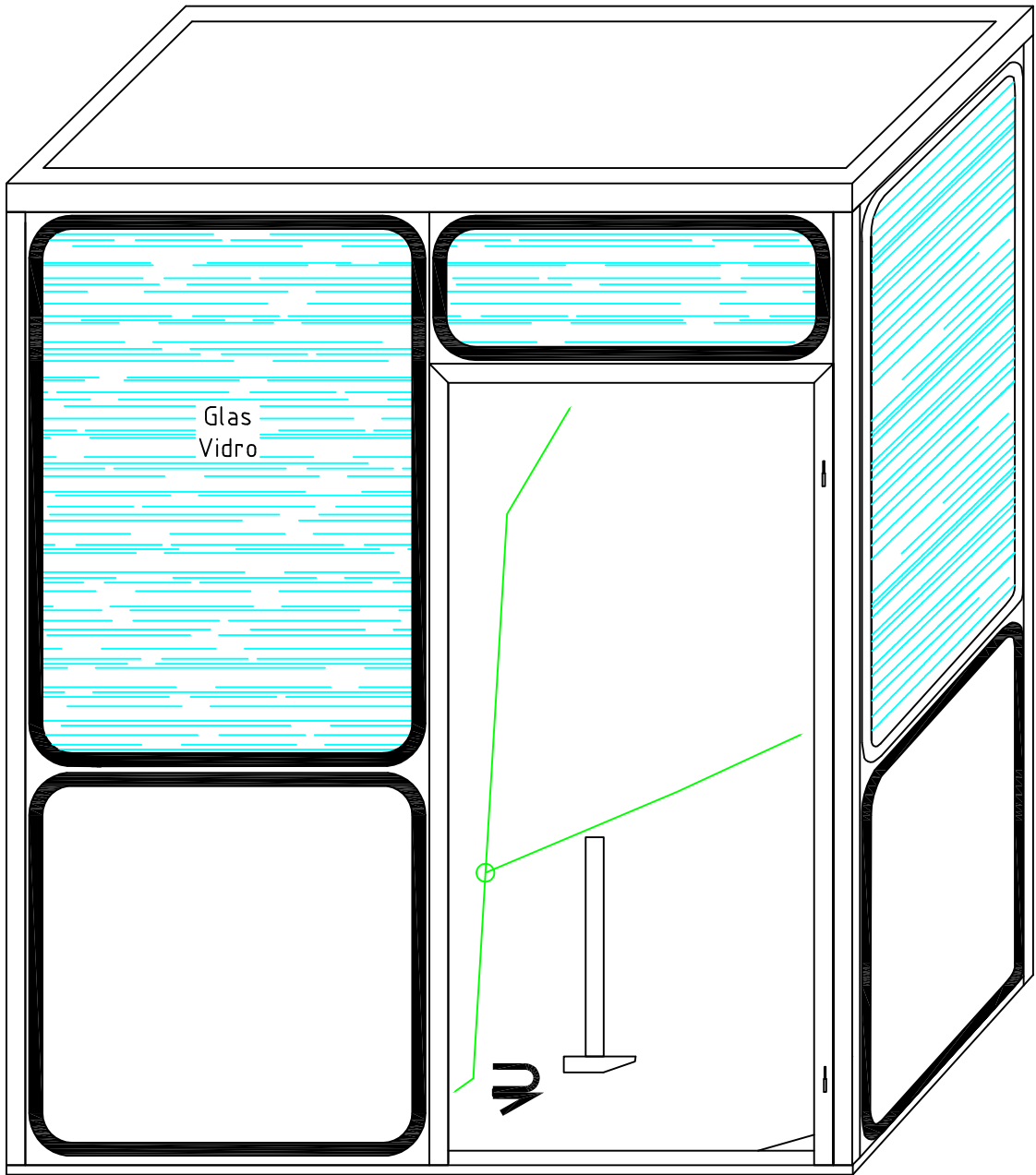
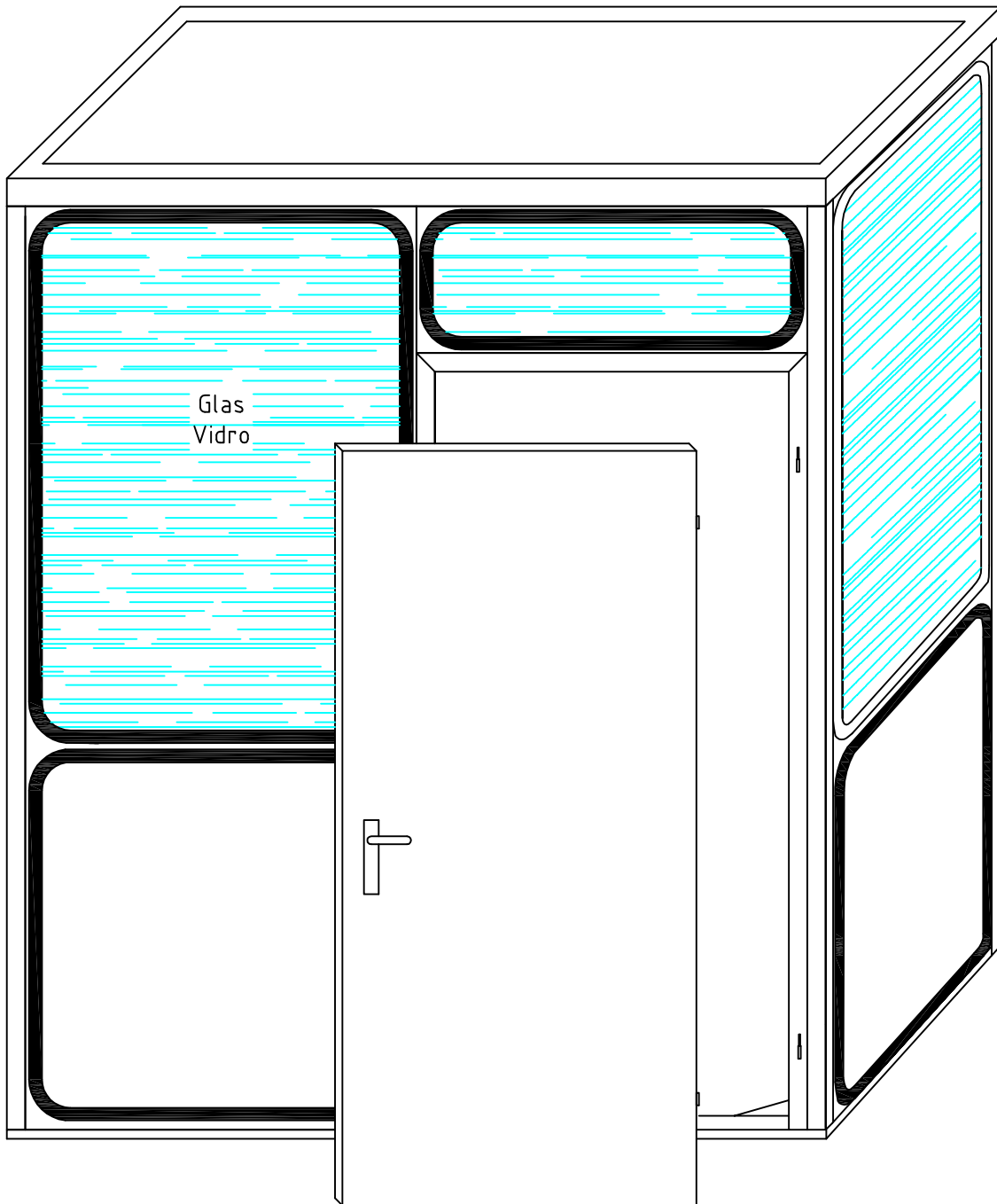
Istruzioni di montaggio

Prefabbricati
multifunzionali

Versione con angolari
arrotondati
Tipo MR

Opzioni:
Pavimento
Rivestimento interno

Istruzioni di montaggio

Sistema modulare di recinto

1. Allineare il telaio di fondamento (Opzionale telaio di montaggio o pavimento). (Fig. 1)
2. Appiccicare il nastro di guarnizione sul telaio tubolare. (Fig. 1)
3. Appiccicare il nastro di guarnizione sui lati longitudinali degli elementi di tetto. (Fig. 2)
4. Avvitare il montante angolare al pannello murale per mezzo delle viti per lamiera. (Fig. 2)
5. Collocare il pannello murale col montante angolare sul telaio di fondamento o di pavimento e avvitare per mezzo delle vite per lamiera. (Fig. 3)
6. Porre insieme i pannelli murali, montanti angolari e porte ed avvitarli. (Fig. 4.0 – 4.2)
7. Appiccicare il nastro di guarnizione sul lato superiore dei pannelli murali. (Fig. 5.0 – 5.1)
8. Collocare il telaio di tetto ed avvitarlo coi pannelli murali. Prefabbricati multifunzionali per interni (Fig. 5.0) – per esterni (Fig. 5.1)
9. Installare porte. (Fig. 8.0 – 8.1)



Optione Rivestimento interno

10. Mettere la lana minerale di 40 mm dal di dentro alle Piastre de lamiera. (Fig. 6)
11. Avvitare i pannelli di masonite, bianco, di 13 mm per mezzo delle viti a testa svasata 4,5 x 30 mm. Spingere le cappe all'interno dei fori situati nelle teste delle viti. (Fig. 7)
12. Pavimento bar montare e fissare.



Le specifiche sono soggette a modifiche.



Abbildung 1
Fig. 1



Abbildung 2
Fig. 2

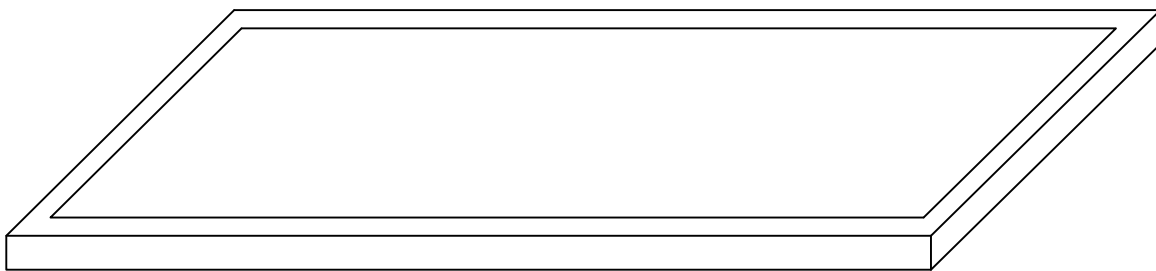
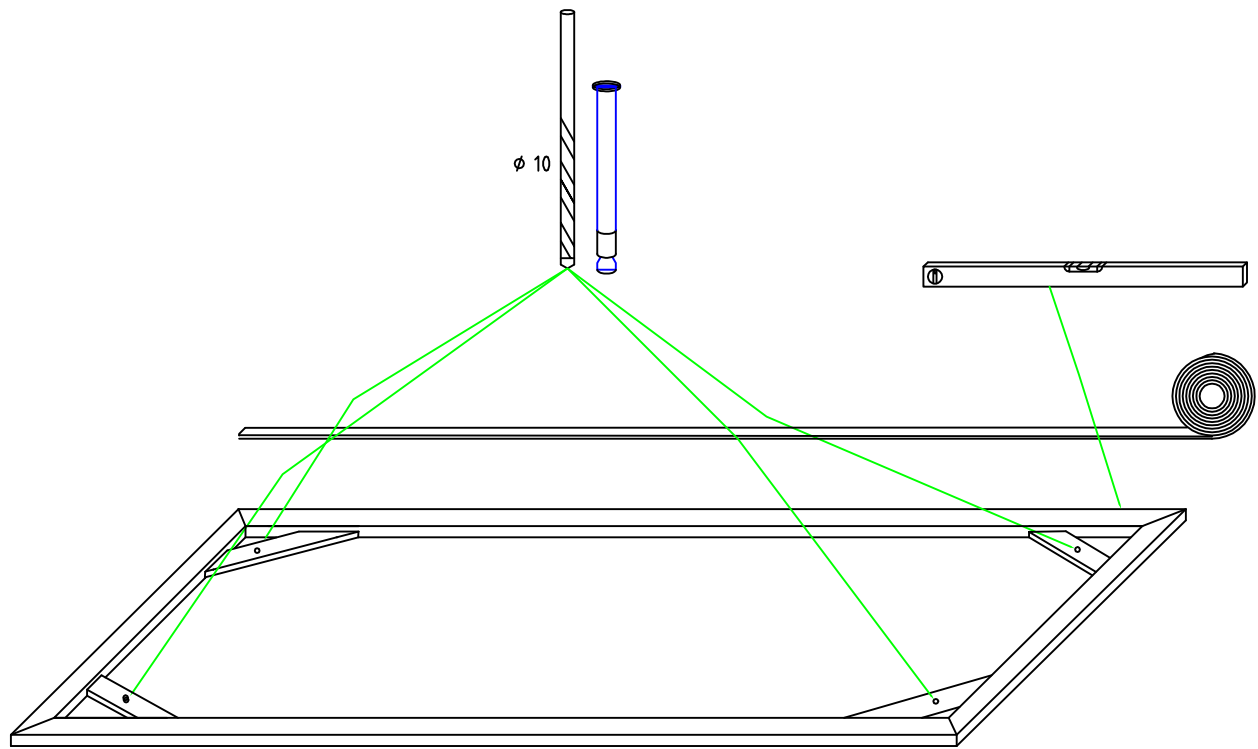

Abbildung 3
Fig. 3

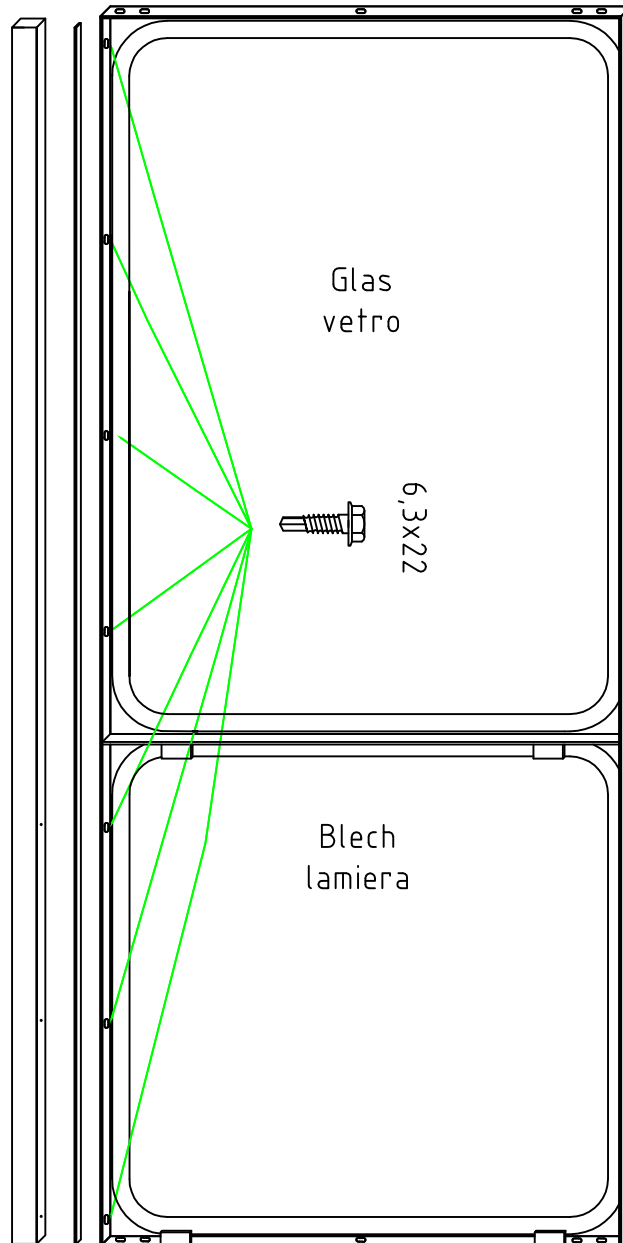

Abbildung 4.0
Fig. 4.0

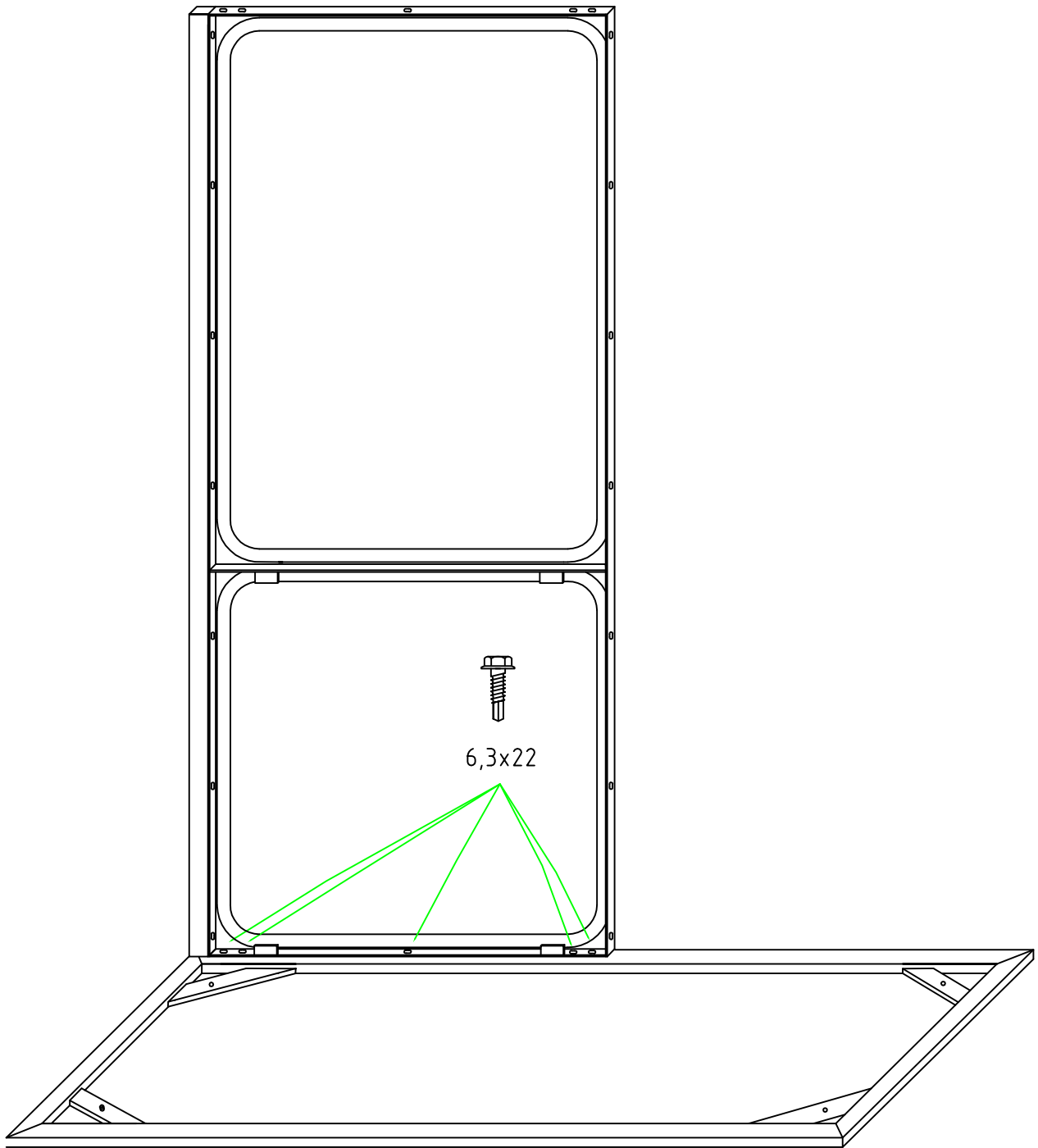

Abbildung 4.1
Fig. 4.1

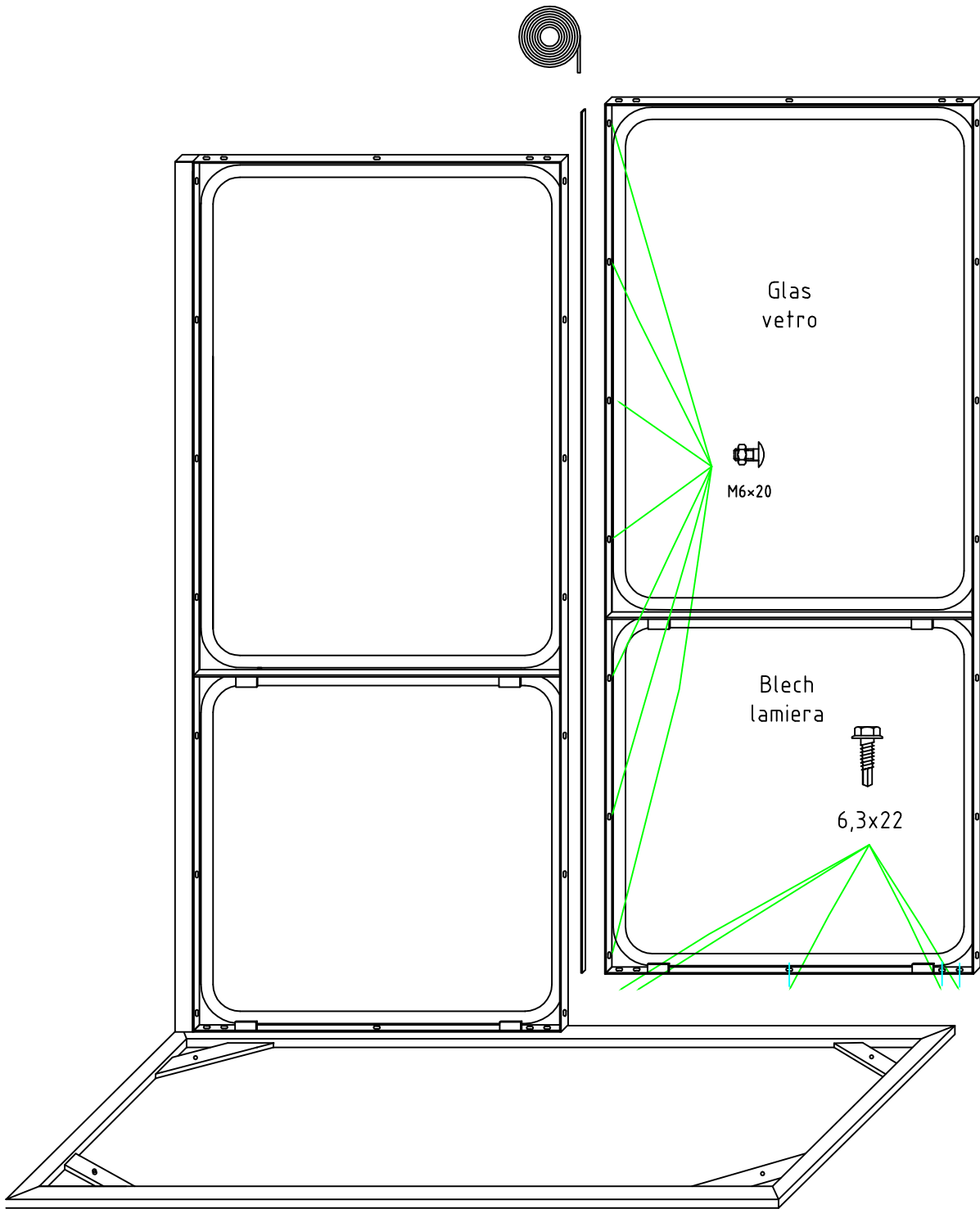

Abbildung 4.2
Fig. 4.2

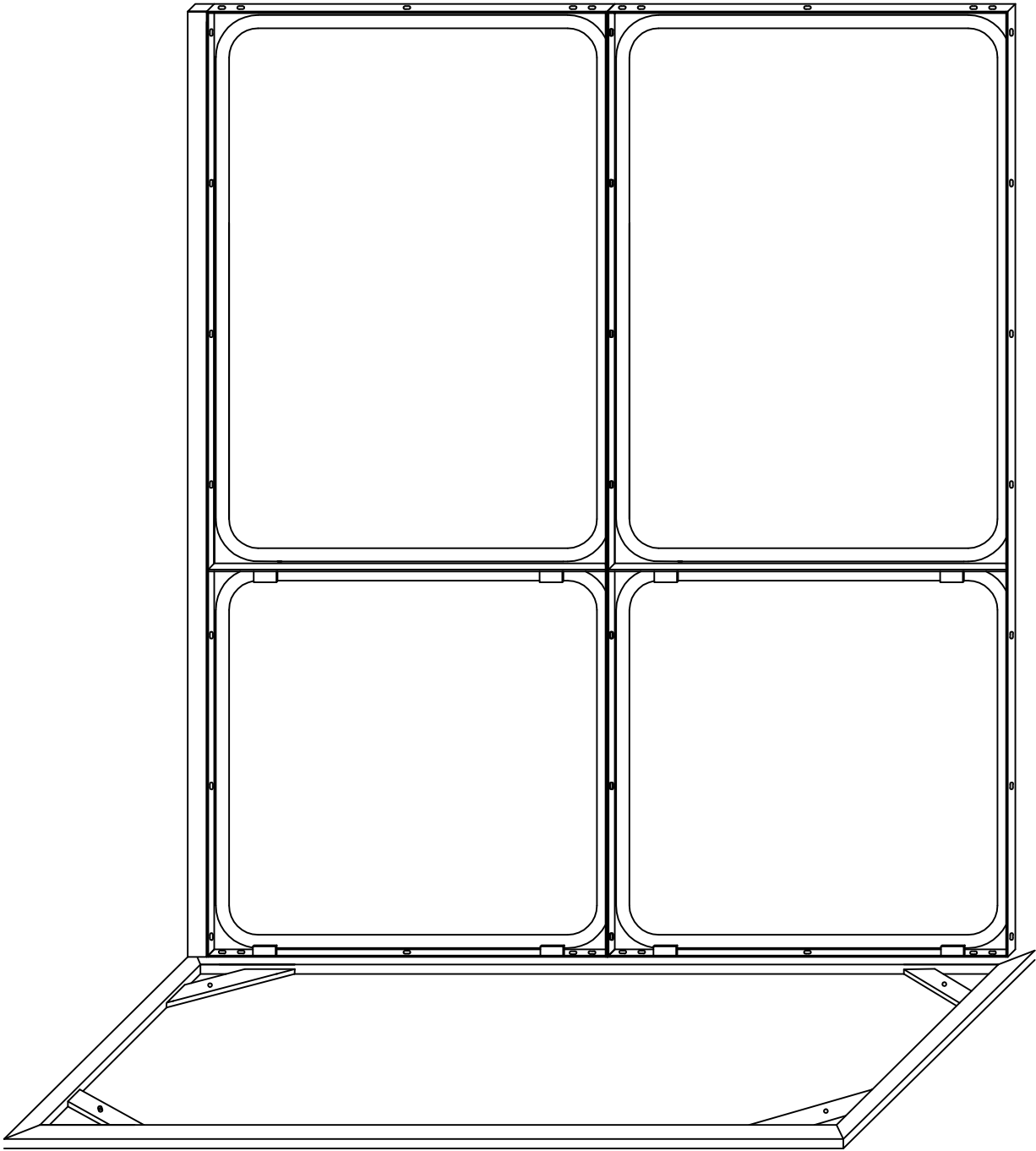

Abbildung 5.0
Fig. 5.0

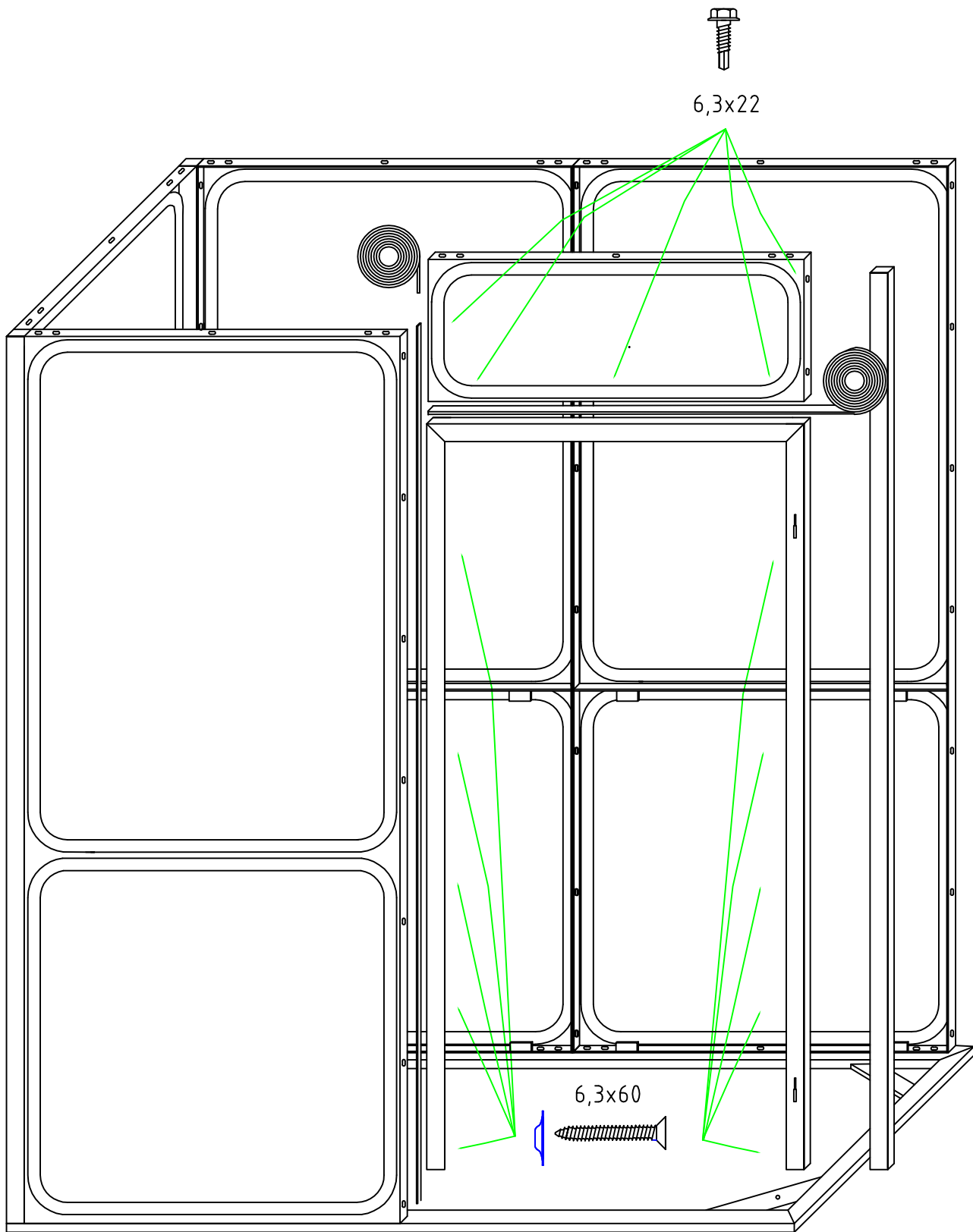

Abbildung 5.1
Fig. 5.1

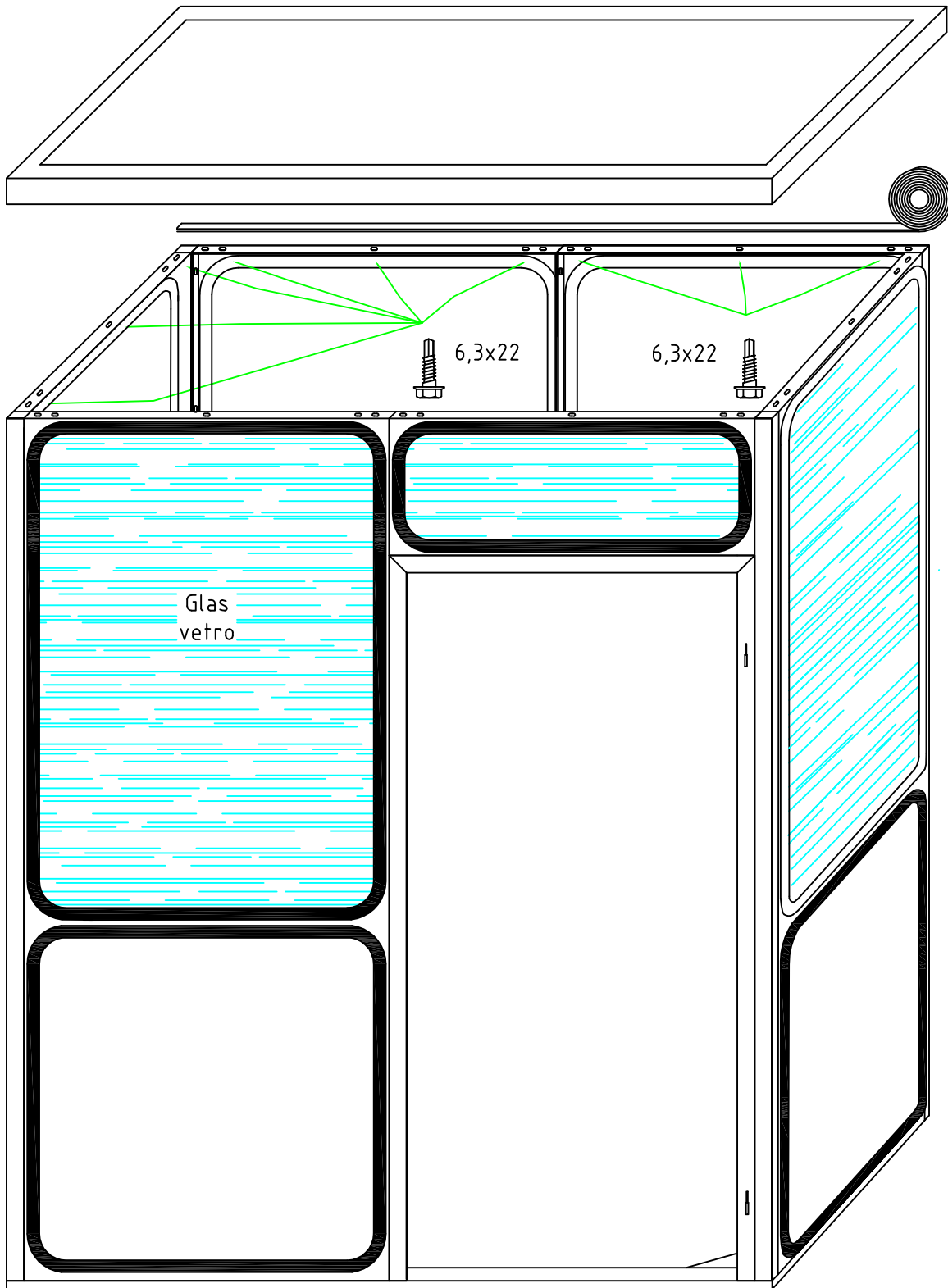

Abbildung 6
Fig. 6

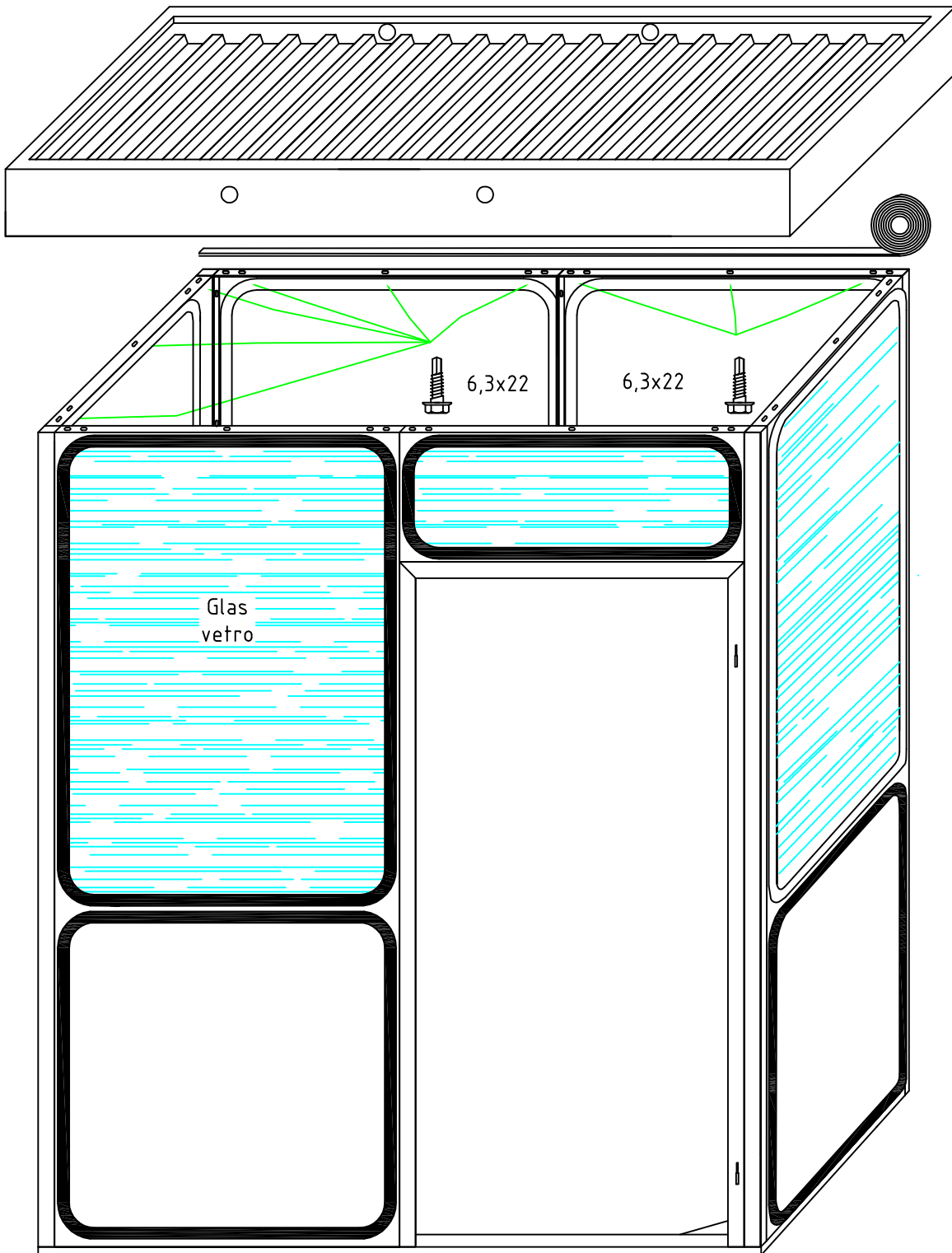

Abbildung 7
Fig. 7

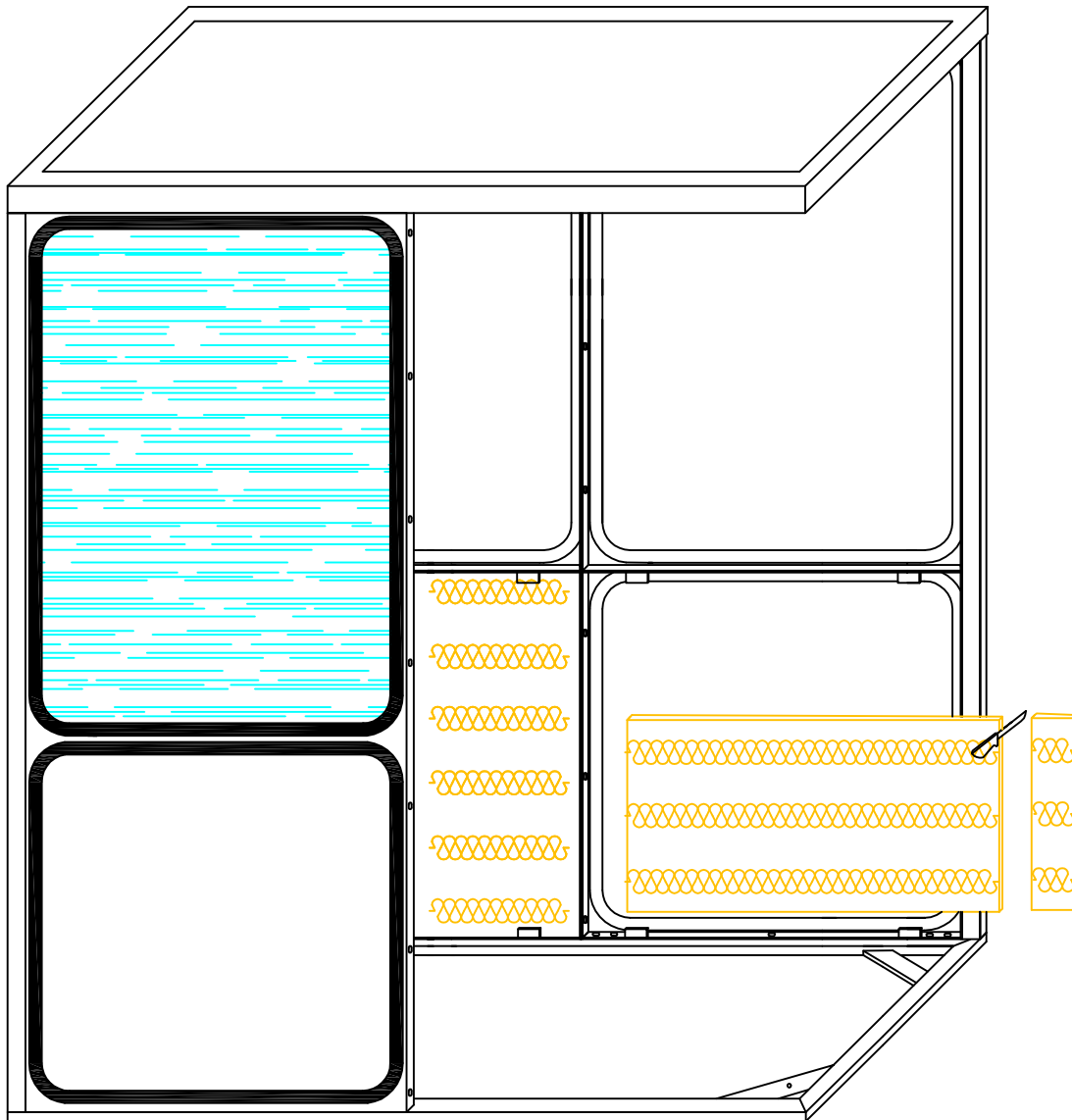

Abbildung 8.0
Fig. 8.0

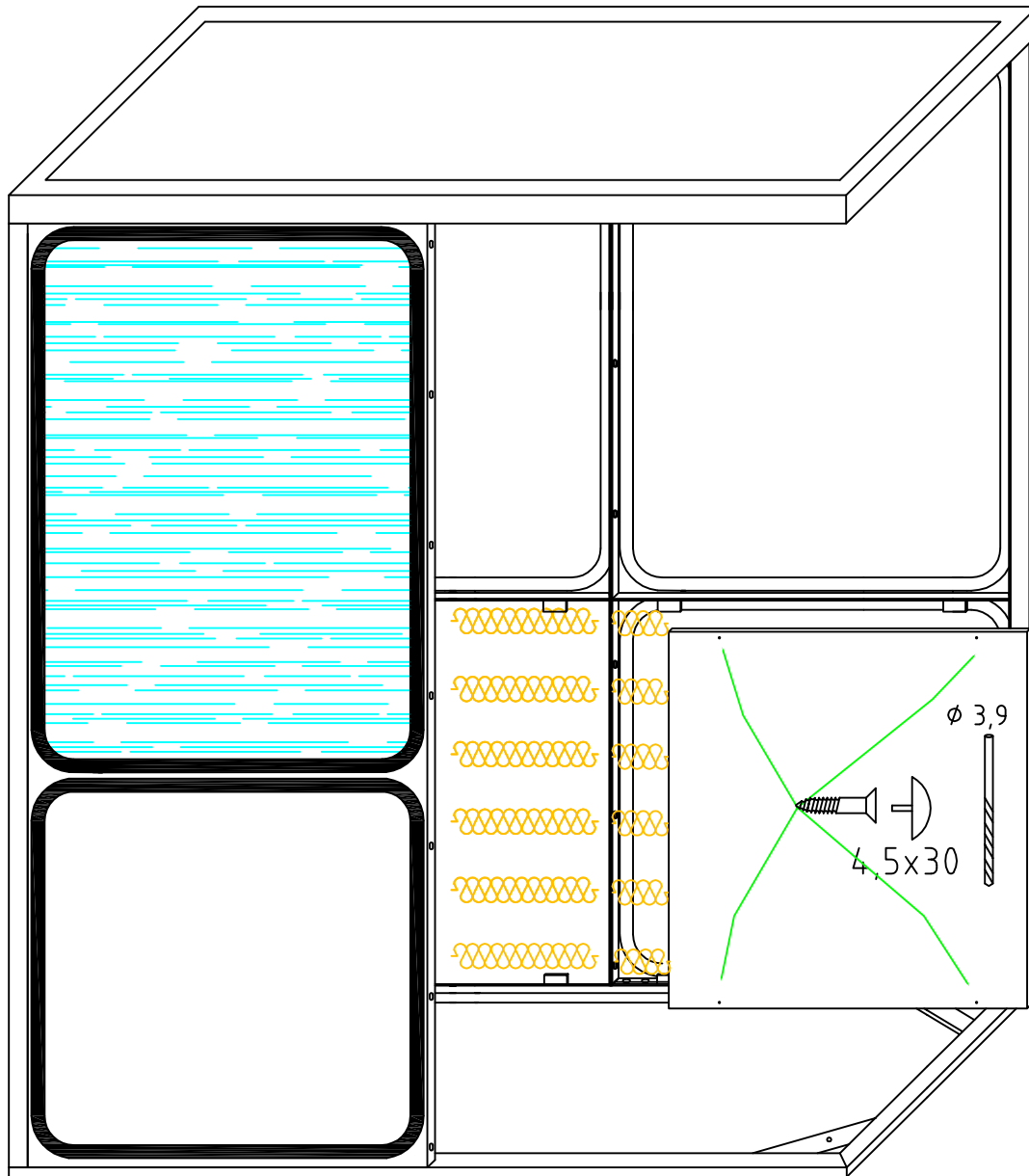

Abbildung 8.1
Fig. 8.1

Montageaanwijzing

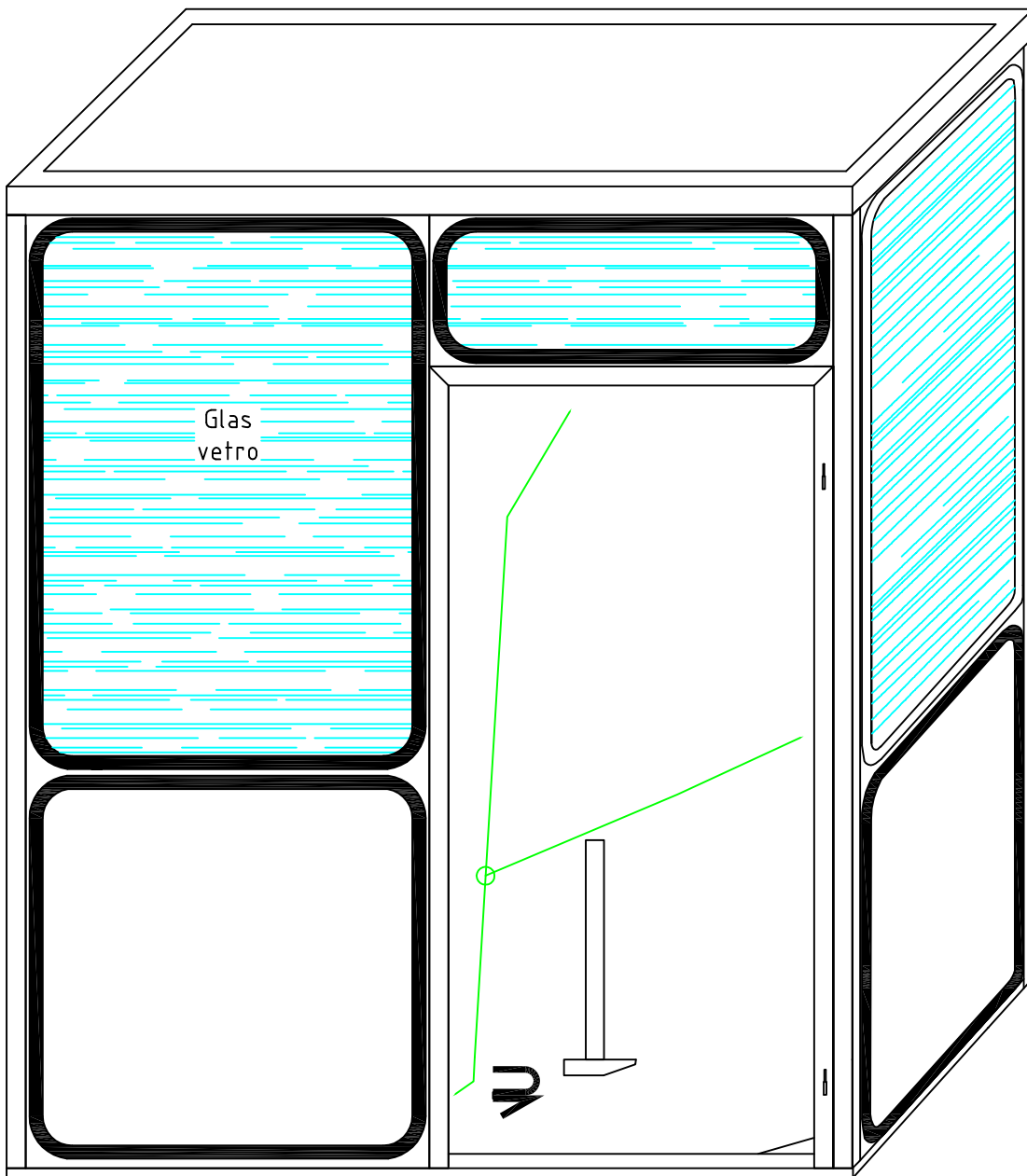
Universele Cabines

Uitvoering met

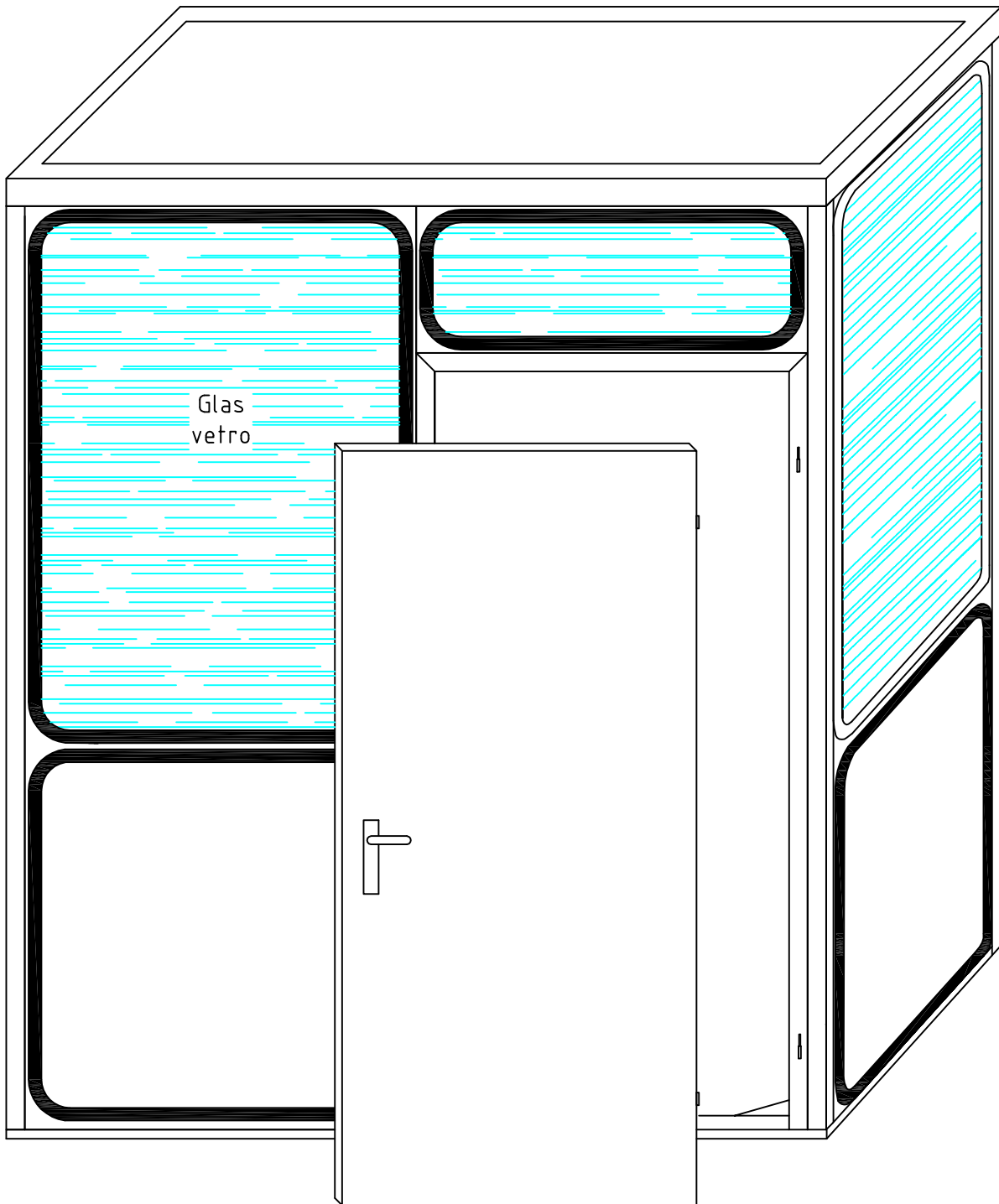
ronde hoeken

Type MR

Opties:

Vloer

Binnenbekleding

Montageaanwijzing

Modulair ruimtesysteem



1. Het bodemframe (Montageframe of optie vloer) richten. (Fig. 1)
2. Pakkingsstrook 15/2 op het buisframe plakken. (Fig. 1)
3. Pakkingsstrook 15/2 op langsijden van de dakelementen plakken. (Fig. 2)
4. Hoekstijlen met plaatschroeven aan het wandelement schroeven. (Fig. 2)
5. Wandelementen met hoekstijlen op het bodemframe stellen en met plaatschroeven dichtschroeven. (Fig. 3)
6. Wandelementen, stijlen en deuren en hoekstijlen aan elkaar stellen en dichtschroeven. (Fig. 4.0 – 4.2)
7. Pakkingsstrook 15/2 op de bovenzijde van de wandelementen plakken. (Fig. 5.0 – 5.1)
8. Het dakframe opleggen en met wandelementen dichtschroeven. Voor binnen (Fig. 5.0) – Voor opstelling buiten (Fig. 5.1)
9. Installeer de deur. (Fig. 8.0 – 8.1)

Optie Binnenbekleding

10. Steenwol 40 mm van binnen aan de platen stellen. (Fig. 6)
11. Spaanplaat wit, 13 mm met zeskantschroef 4,5 x 30 mm aan de wandelementen aanschroeven. Kappen in kopopeningen van de schroeven drukken. (Fig. 7)
12. Plint monteren.



Wijzigingen in het ontwerp voorbehouden.



Abbildung 1
Fig. 1



Abbildung 2
Fig. 2

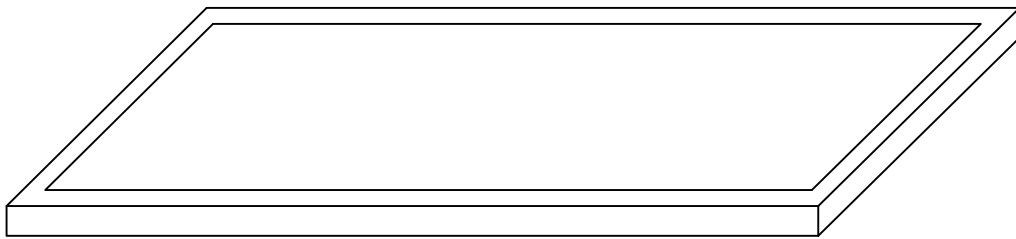
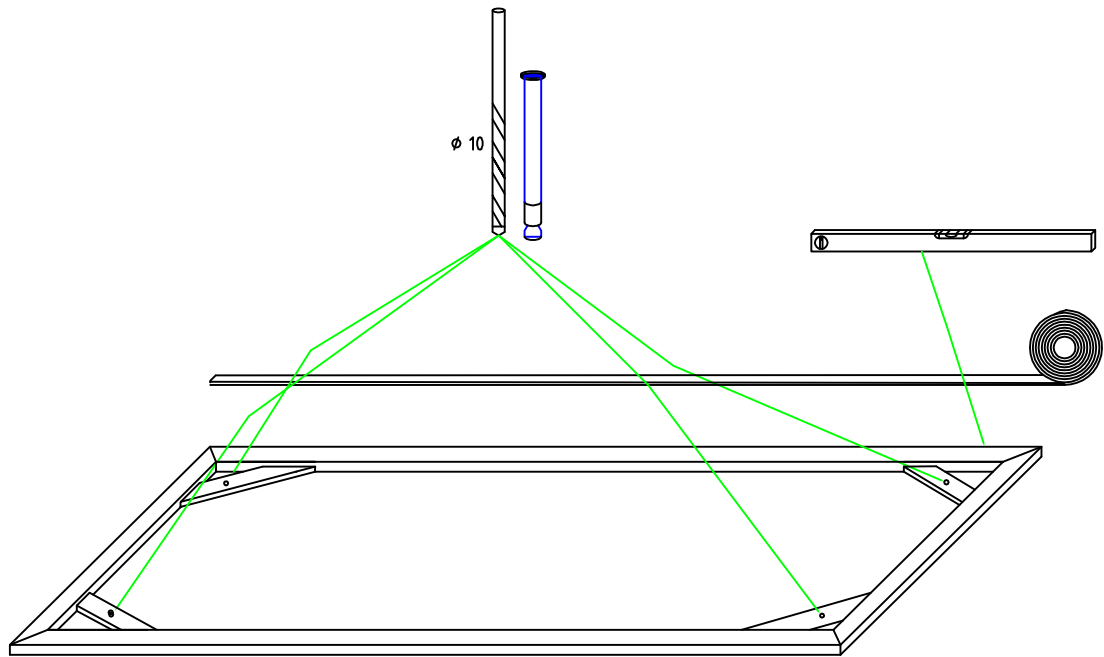

Abbildung 3
Fig. 3

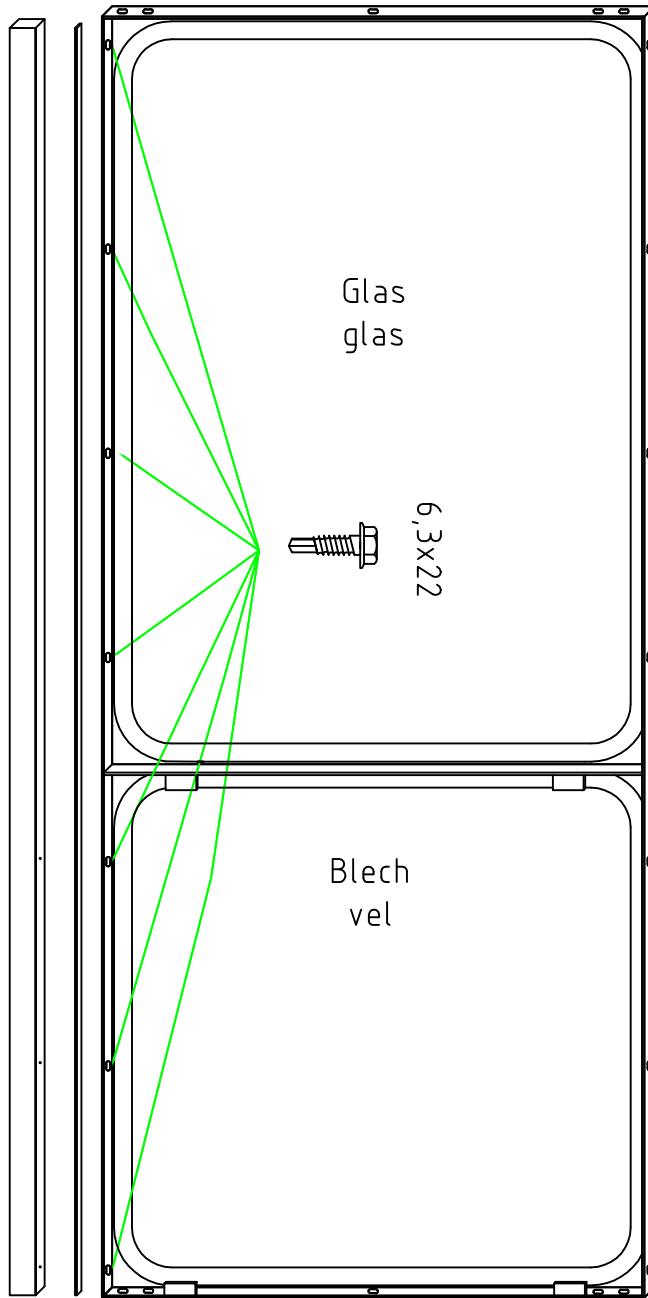

Abbildung 4.0
Fig. 4.0

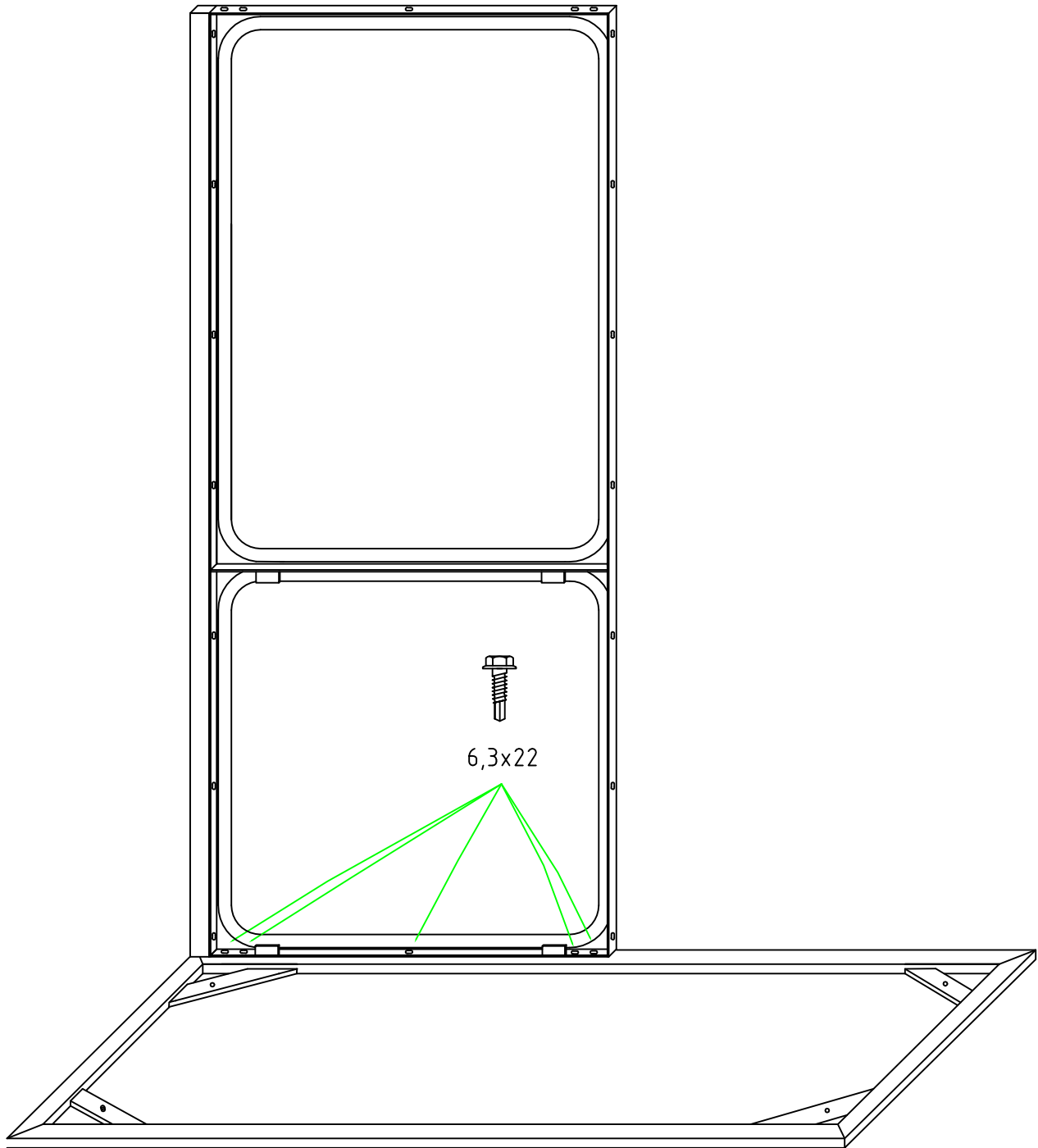

Abbildung 4.1
Fig. 4.1

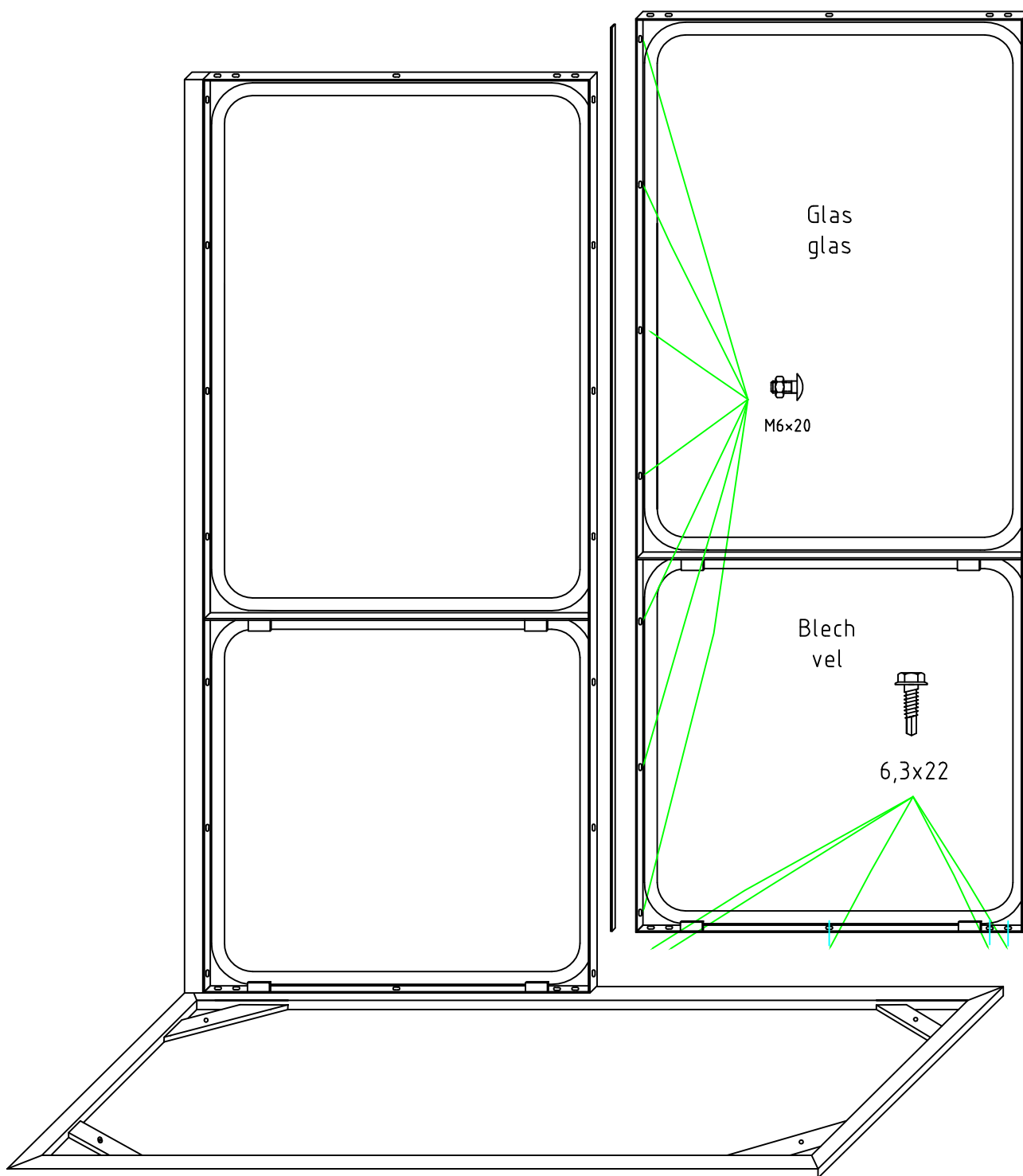

Abbildung 4.2
Fig. 4.2

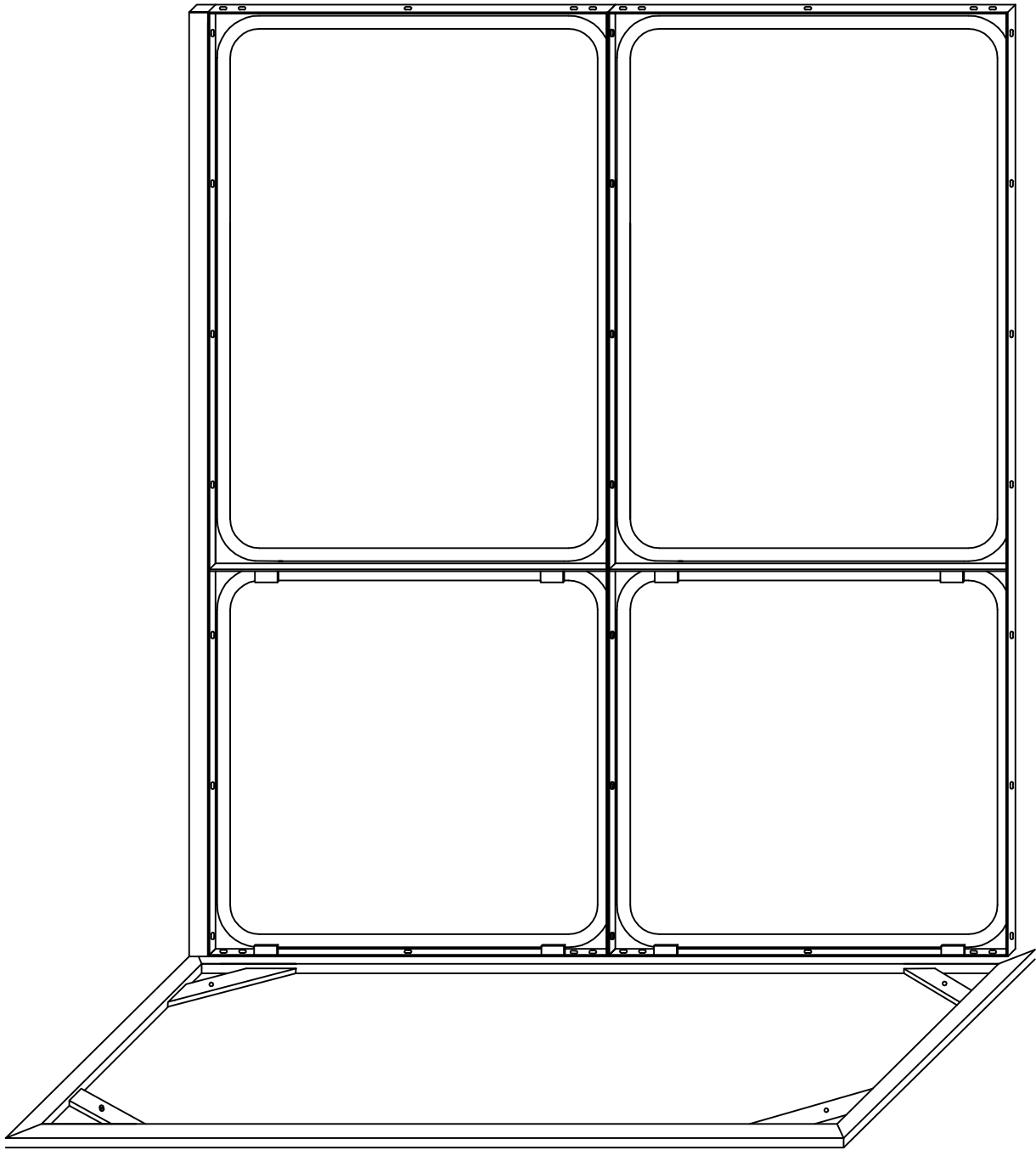

Abbildung 5.0
Fig. 5.0

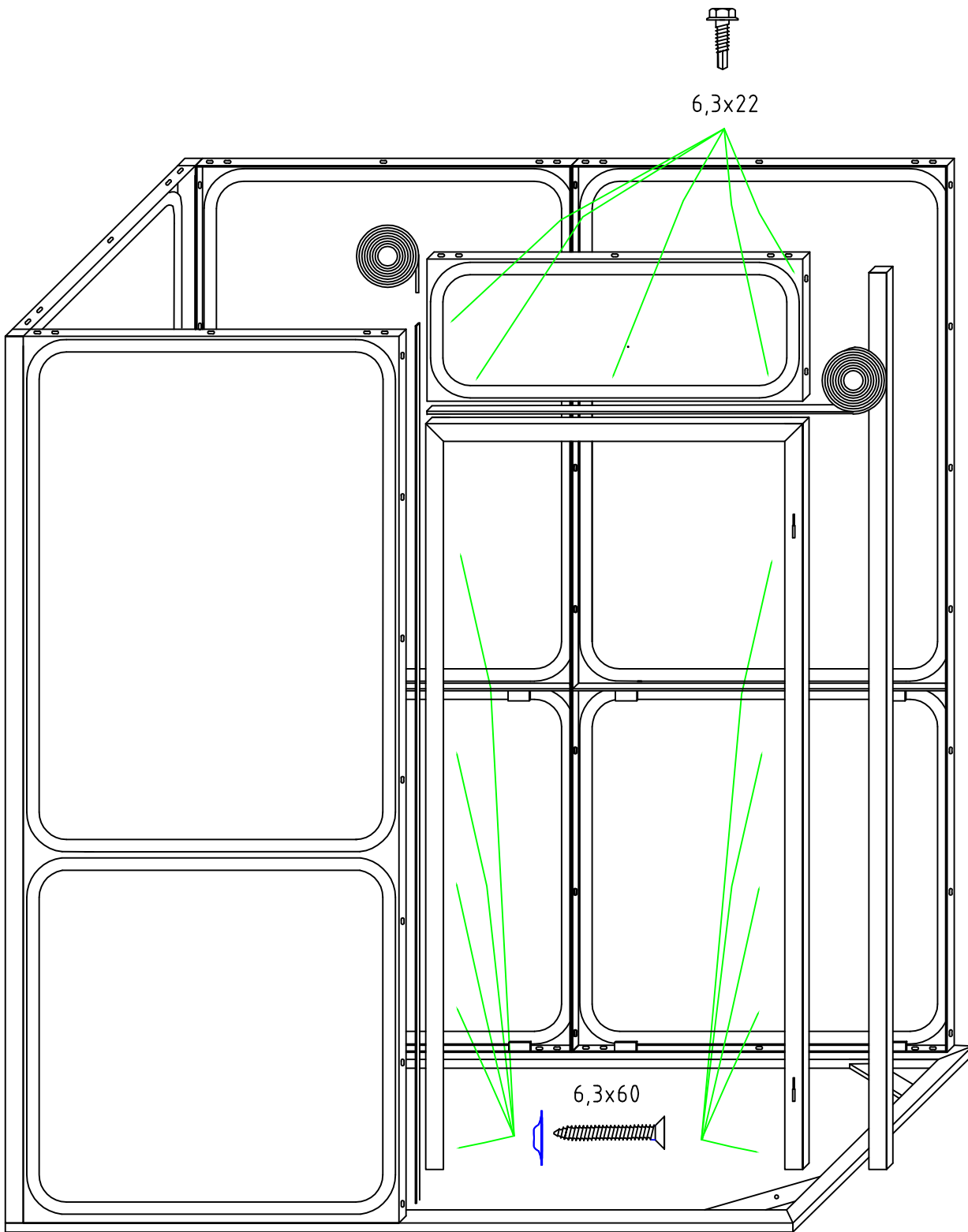

Abbildung 5.1
Fig. 5.1

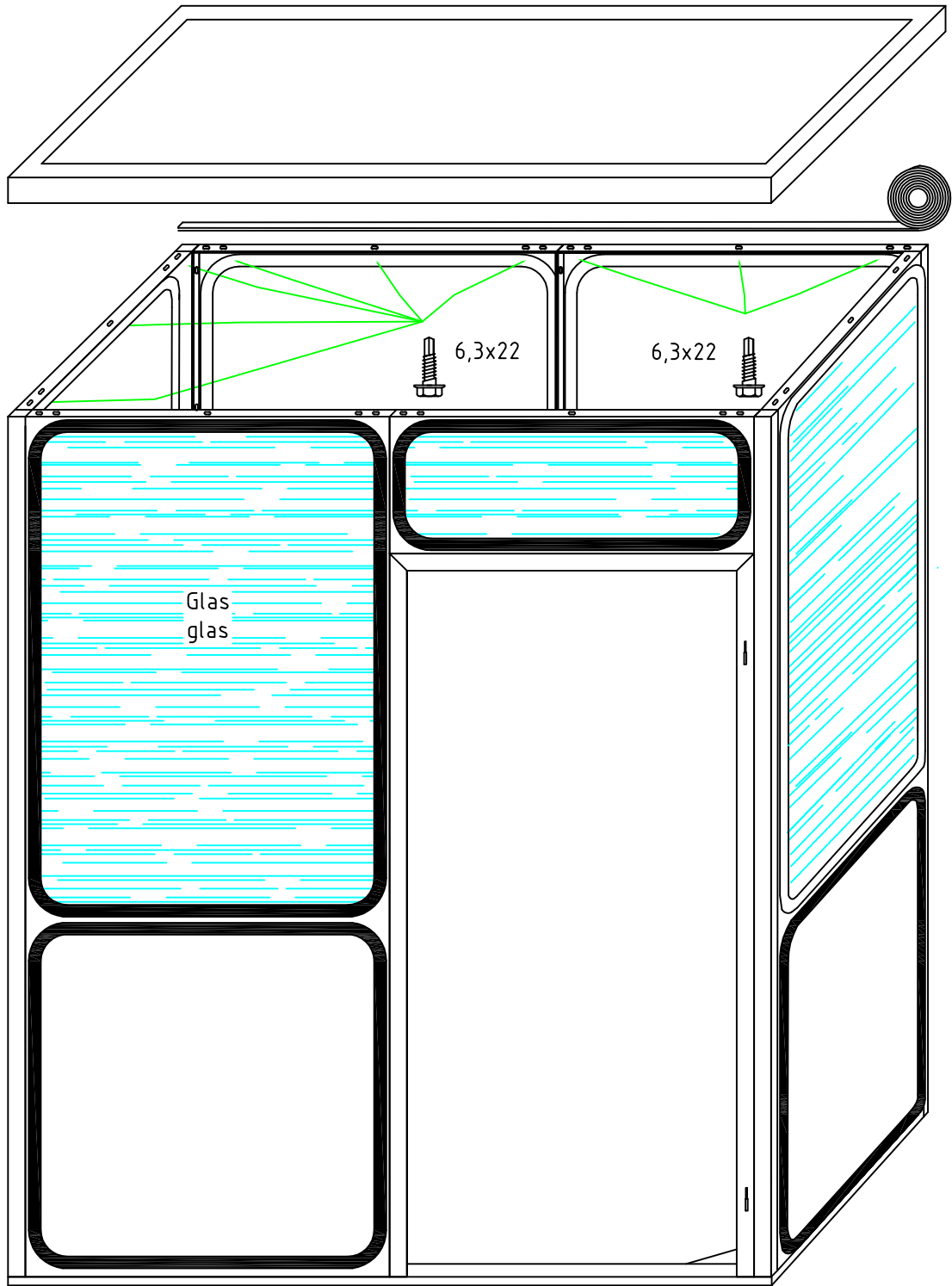

Abbildung 6
Fig. 6

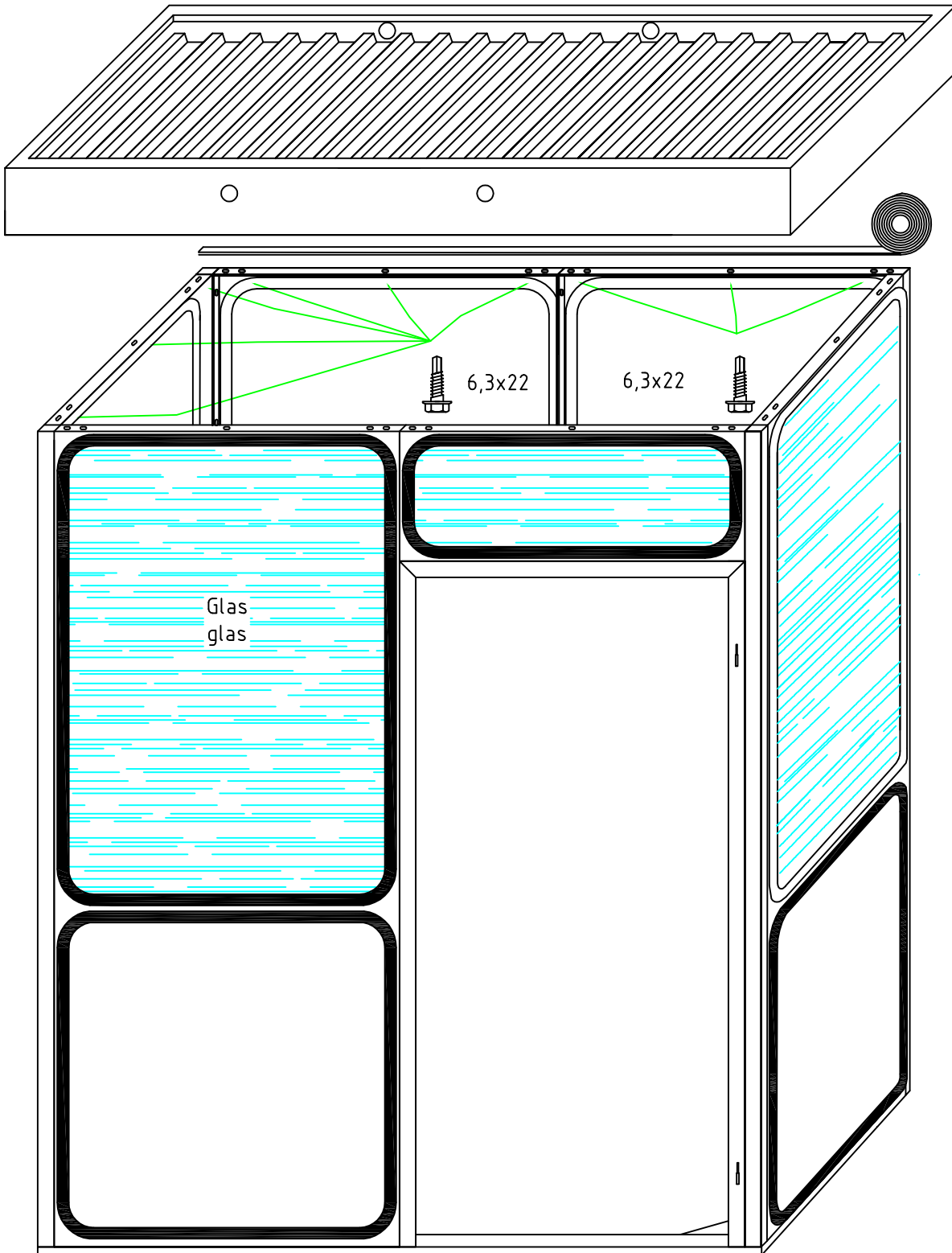

Abbildung 7
Fig. 7

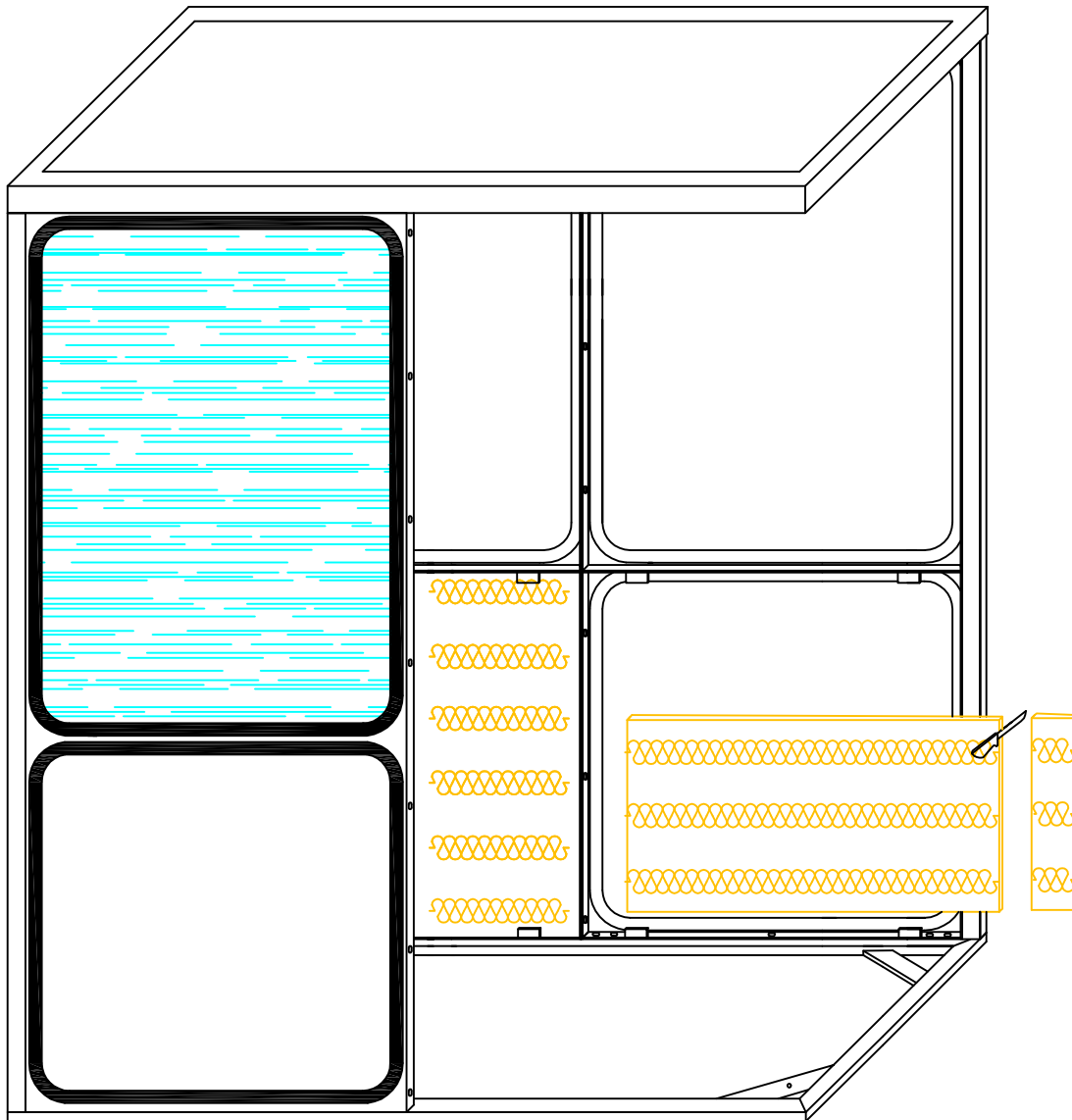

Abbildung 8.0
Fig. 8.0

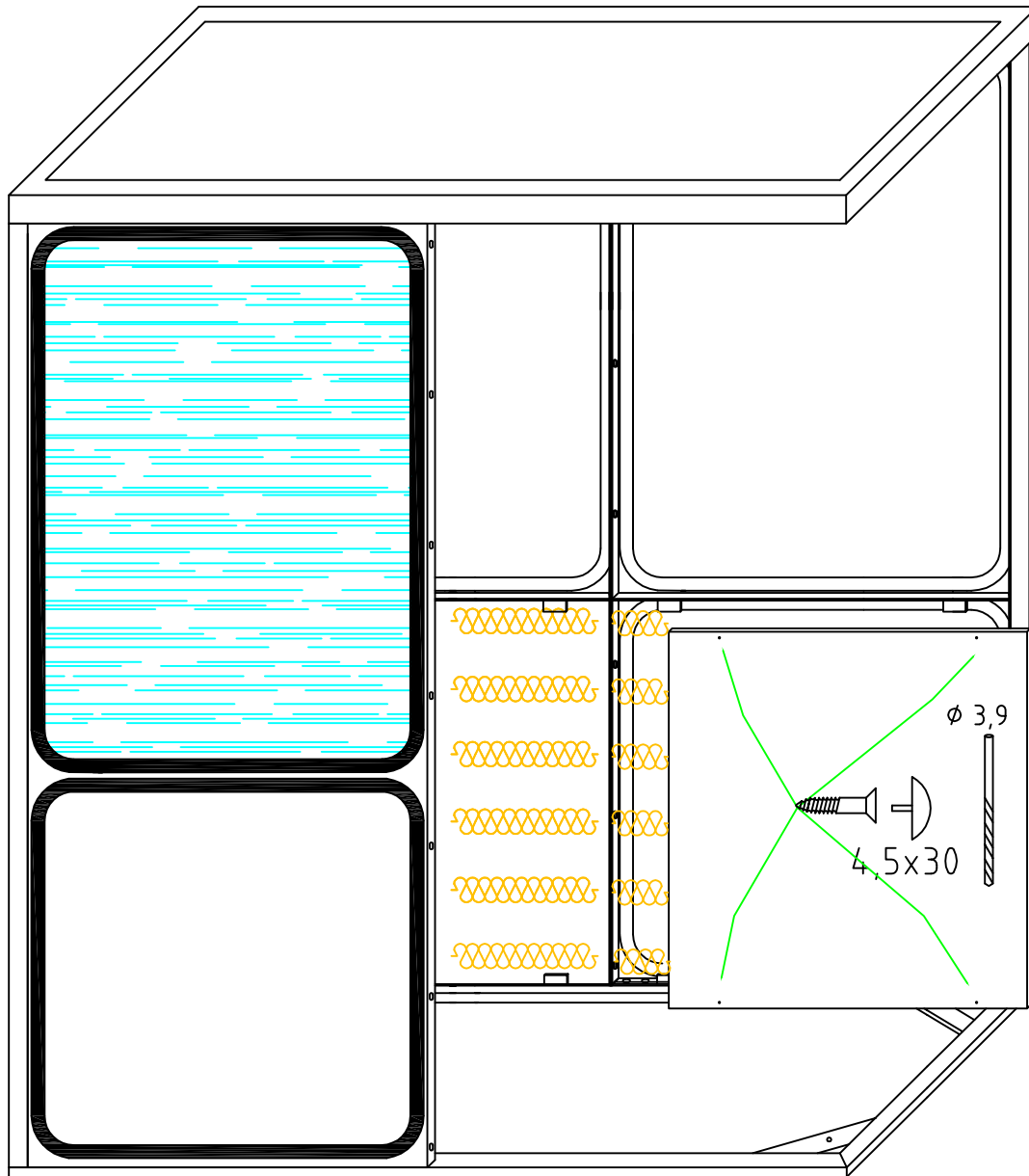

Abbildung 8.1
Fig. 8.1

Popis montáže

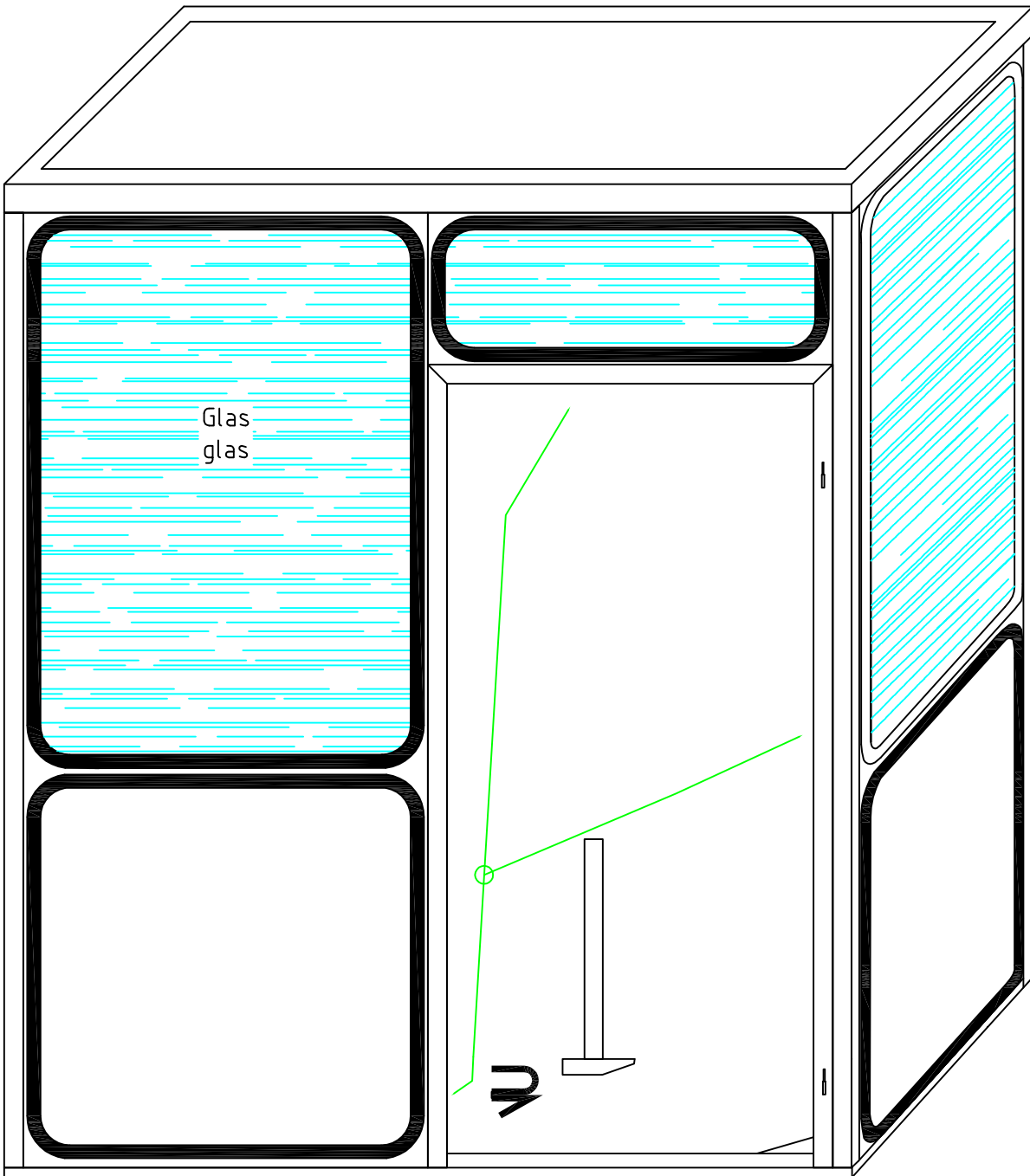
Víceúčelové domky
Provedení se zaoblenými
rohy Typ MR

Volitelné doplňky:
Podlaha
Vnitřní obložení

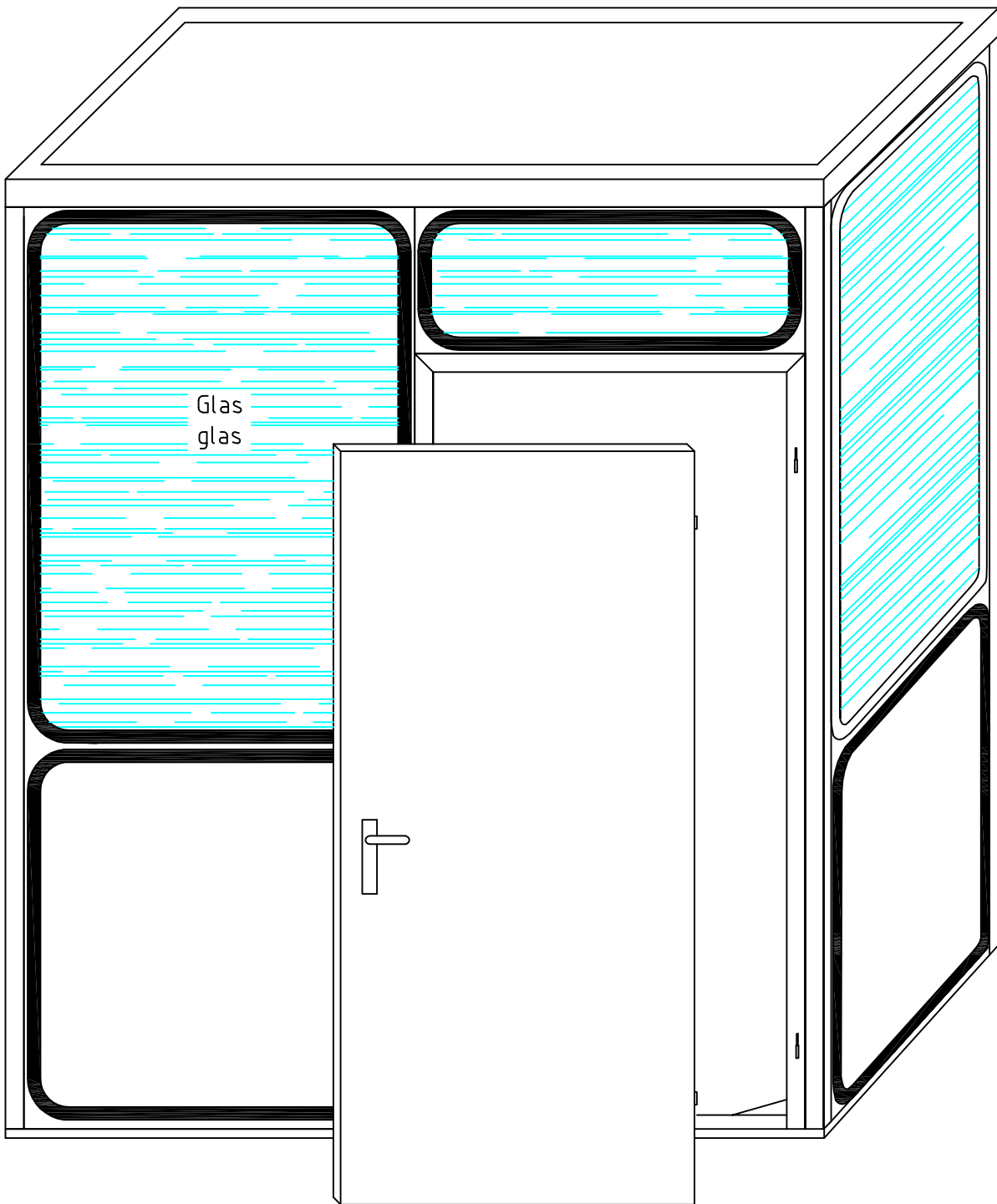
Popis montáže

Modulární prostorový systém

1. Vyrovnat spodní rám (možnost podlaha nebo montážní rám). (Fig. 1)
2. Na trubkový rám nalepit těsnící pásku. (Fig. 1)
3. Nalepit těsnící pásku na podélné strany střešních prvků. (Fig. 2)
4. Pomocí šroubů do plechu našroubovat rohové sloupy na stěnový dílec. (Fig. 2)
5. Stěnový dílec se sloupem nasunout na spondí rám a sešroubovat šrouby do plechu. (Fig. 3)
6. Stěnové dílec, sloupy a dveře postavit vedle sebe a sešroubovat. (Fig. 4.0 – 4.2)
7. Nalepit těsnící pásku na horní stranu stěnových dílců. (Fig. 5.0 – 5.1)
8. Přiložit střešní rám a sešroubovat se stěnovým dílcem. Použít šrouby do plechu. Vnitřní interiéru (Fig. 5.0) – venkovní instalaci (Fig. 5.1)
9. Dveře namontovat. (Fig. 8.0 – 8.1)



Volitelné doplňky - Vnitřní obložení

10. Přiložit minerální vlnu 40 mm z vnitřní strany na plechy. (Fig. 6)
11. Přišroubovat třískovou desku 13 mm šrouby SK 4,5 x 30. Vtlačit víčka do otvoru hlavičky šroubu. (Fig. 7)
12. Nožní lištu upevnit hřebíky.



Návrh změny jsou vyhrazeny.



Abbildung 1
Fig. 1



Abbildung 2
Fig. 2

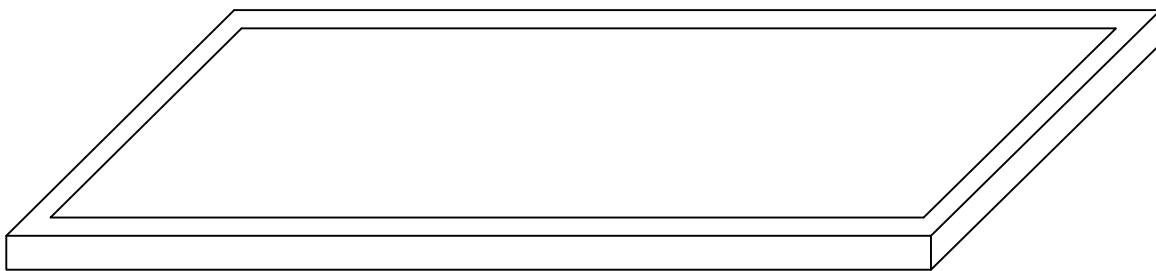
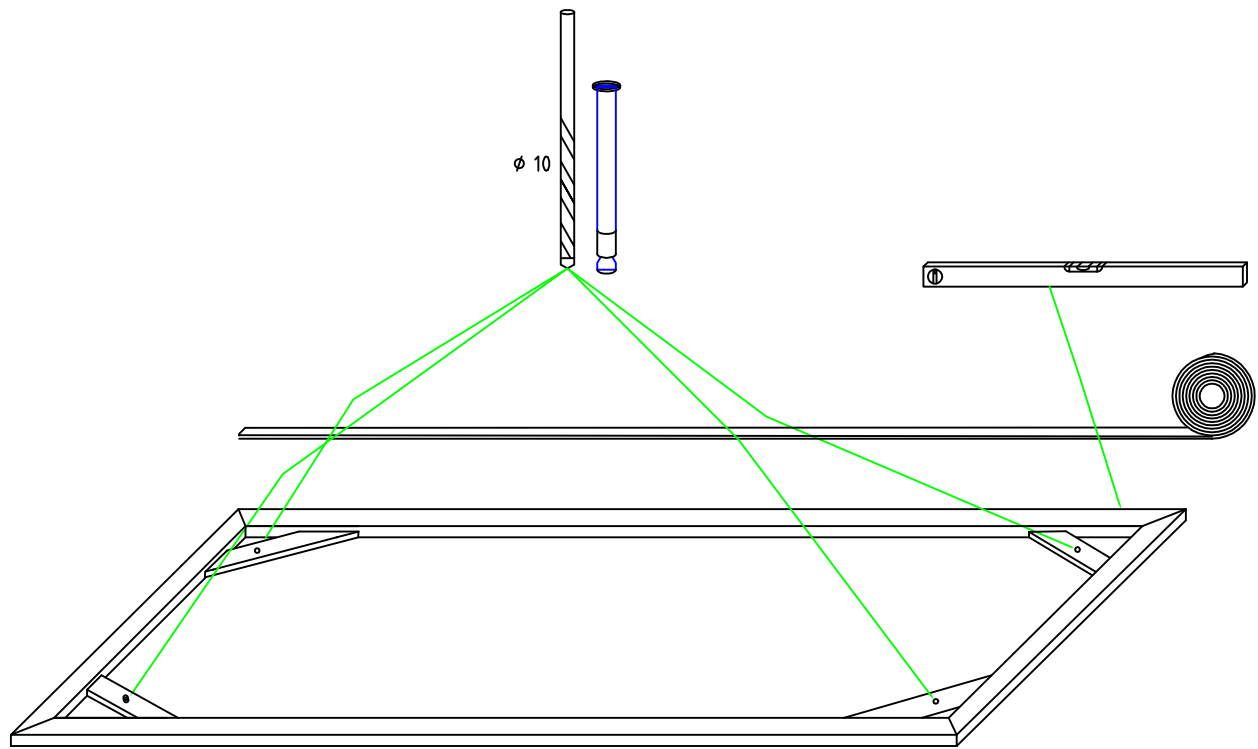

Abbildung 3
Fig. 3

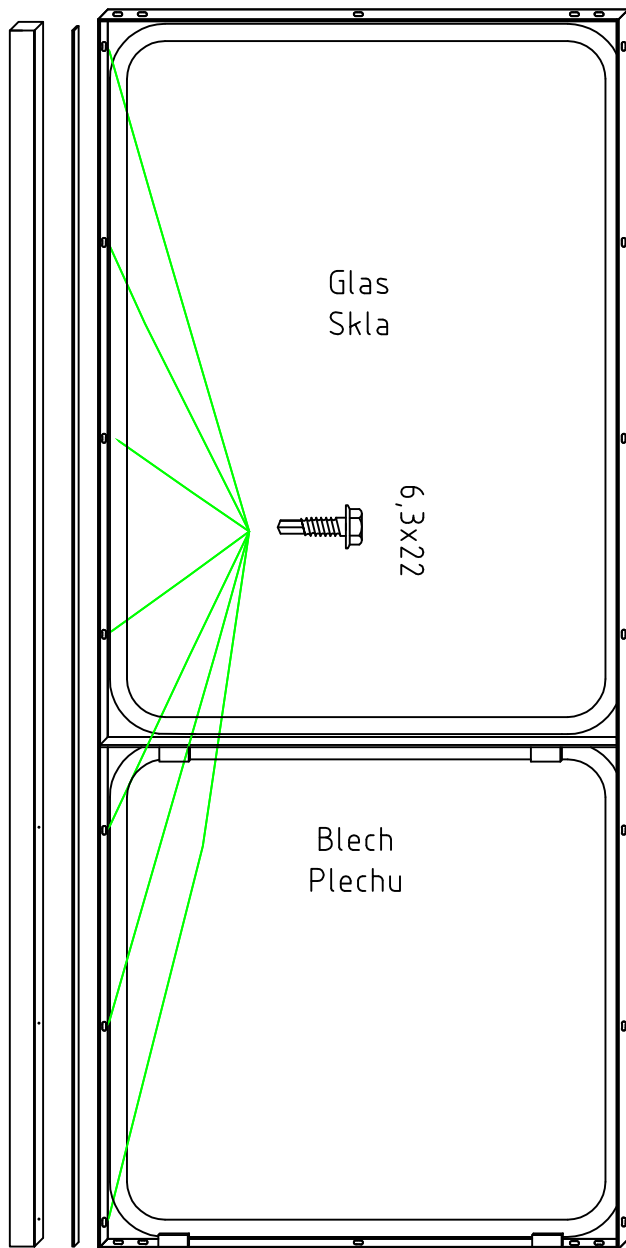

Abbildung 4.0
Fig. 4.0

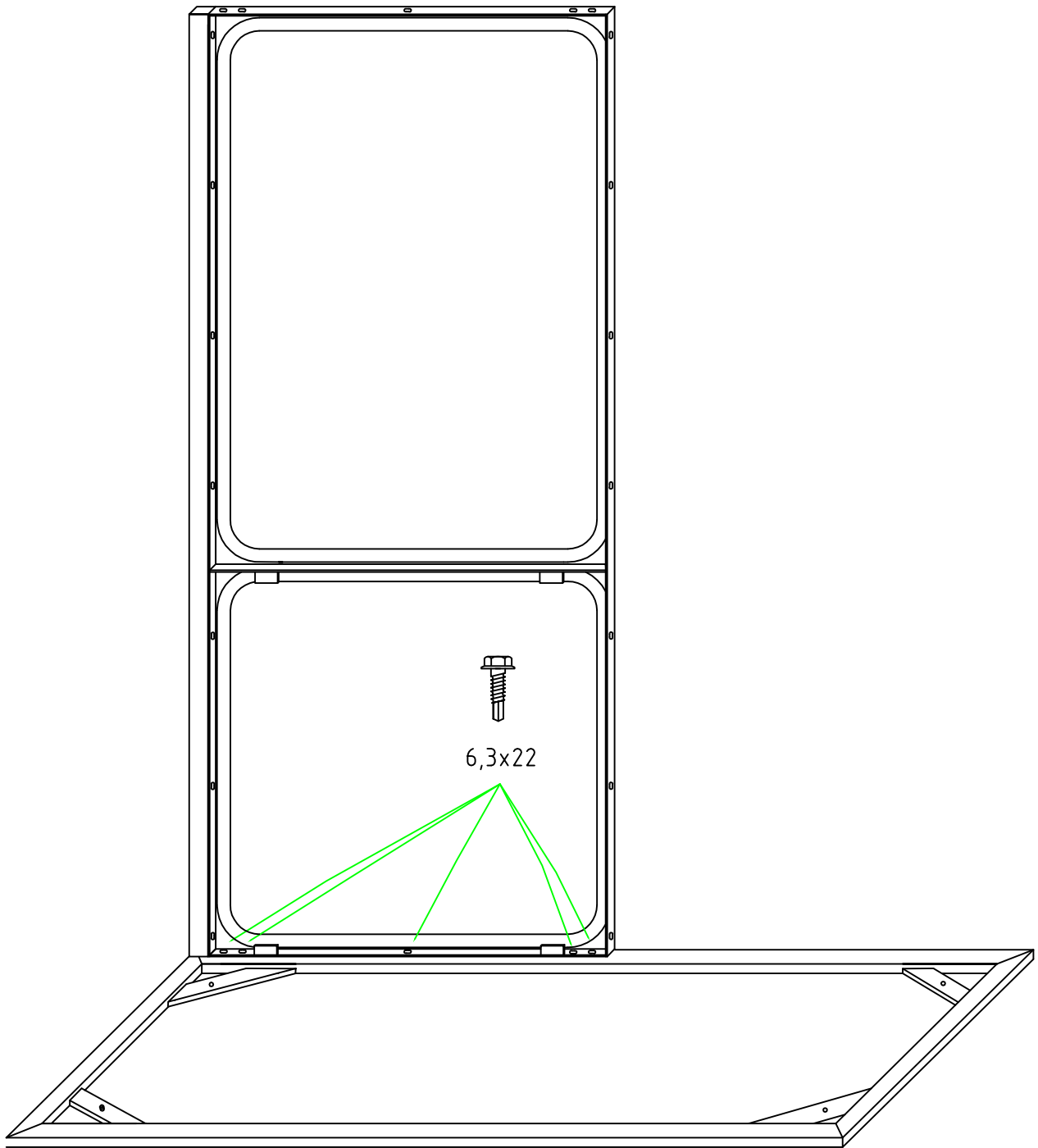

Abbildung 4.1
Fig. 4.1

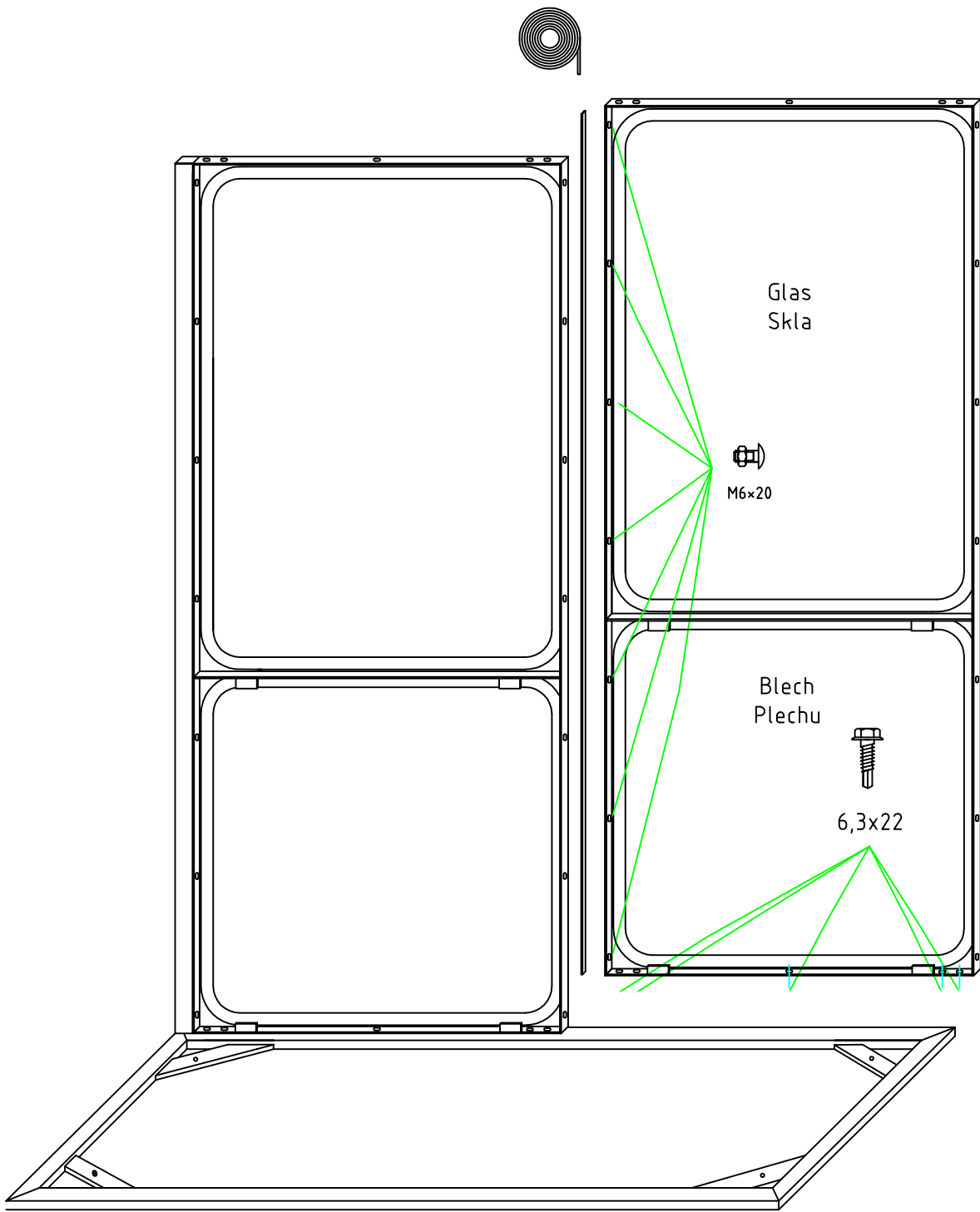

Abbildung 4.2
Fig. 4.2

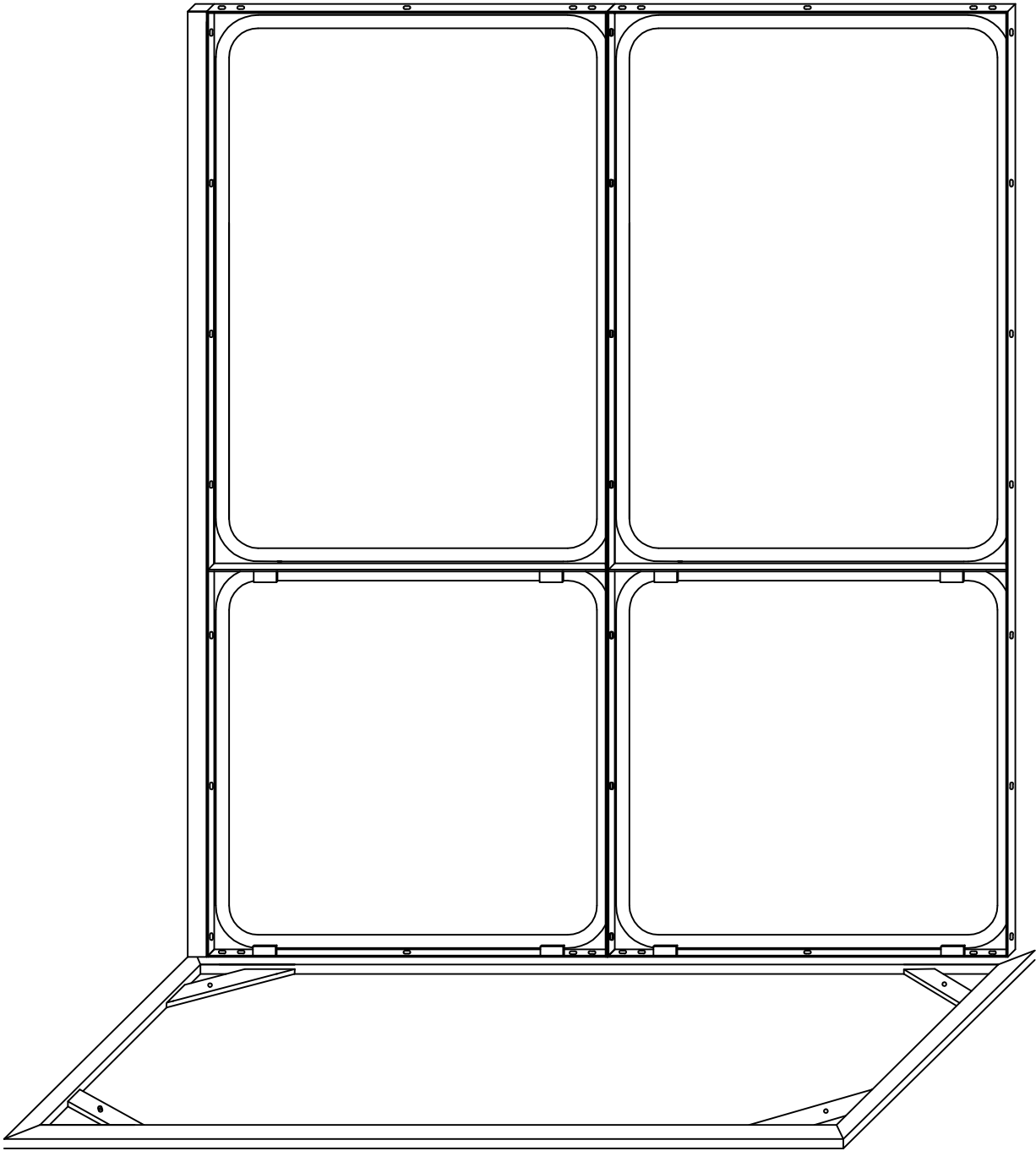

Abbildung 5.0
Fig. 5.0

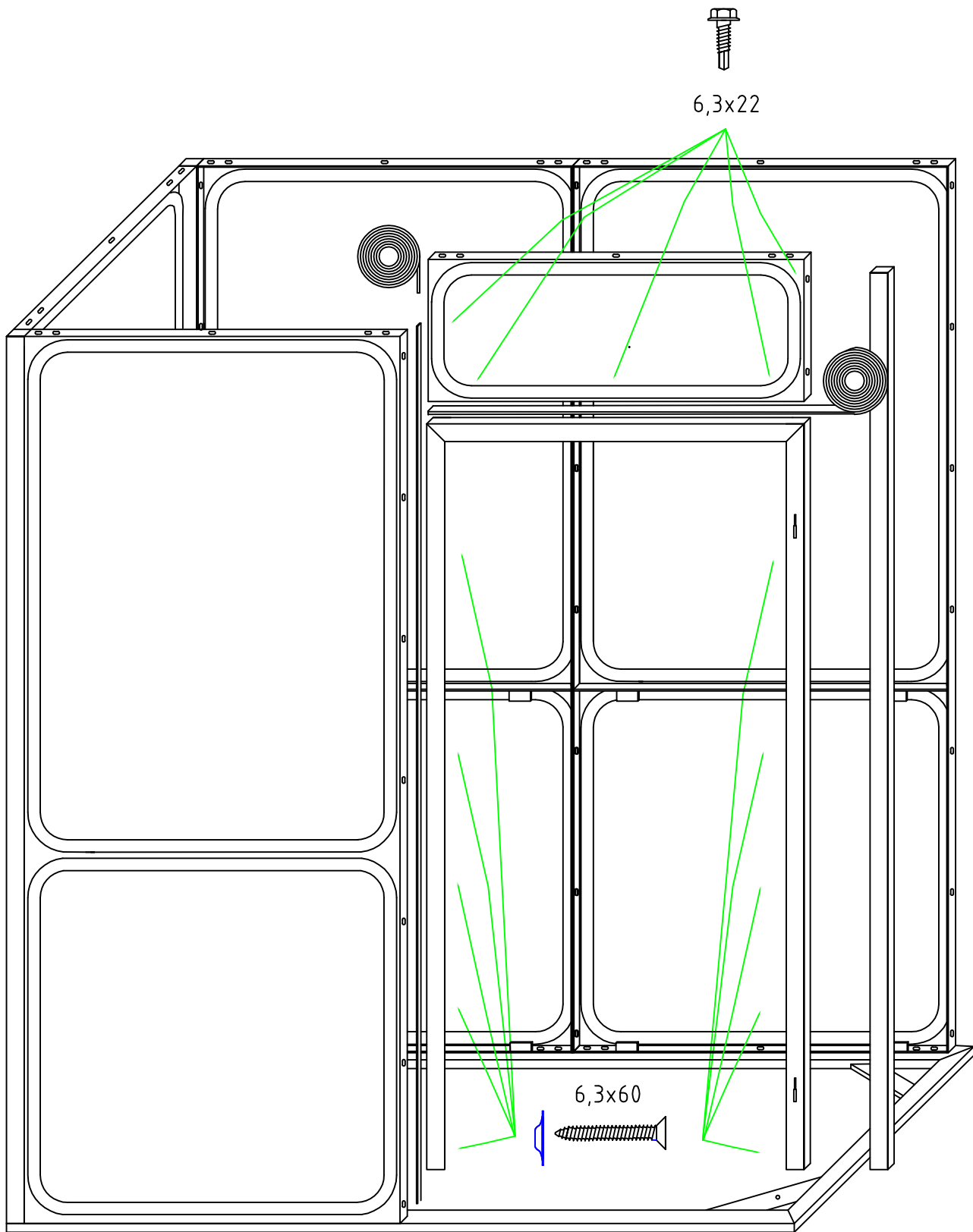

Abbildung 5.1
Fig. 5.1

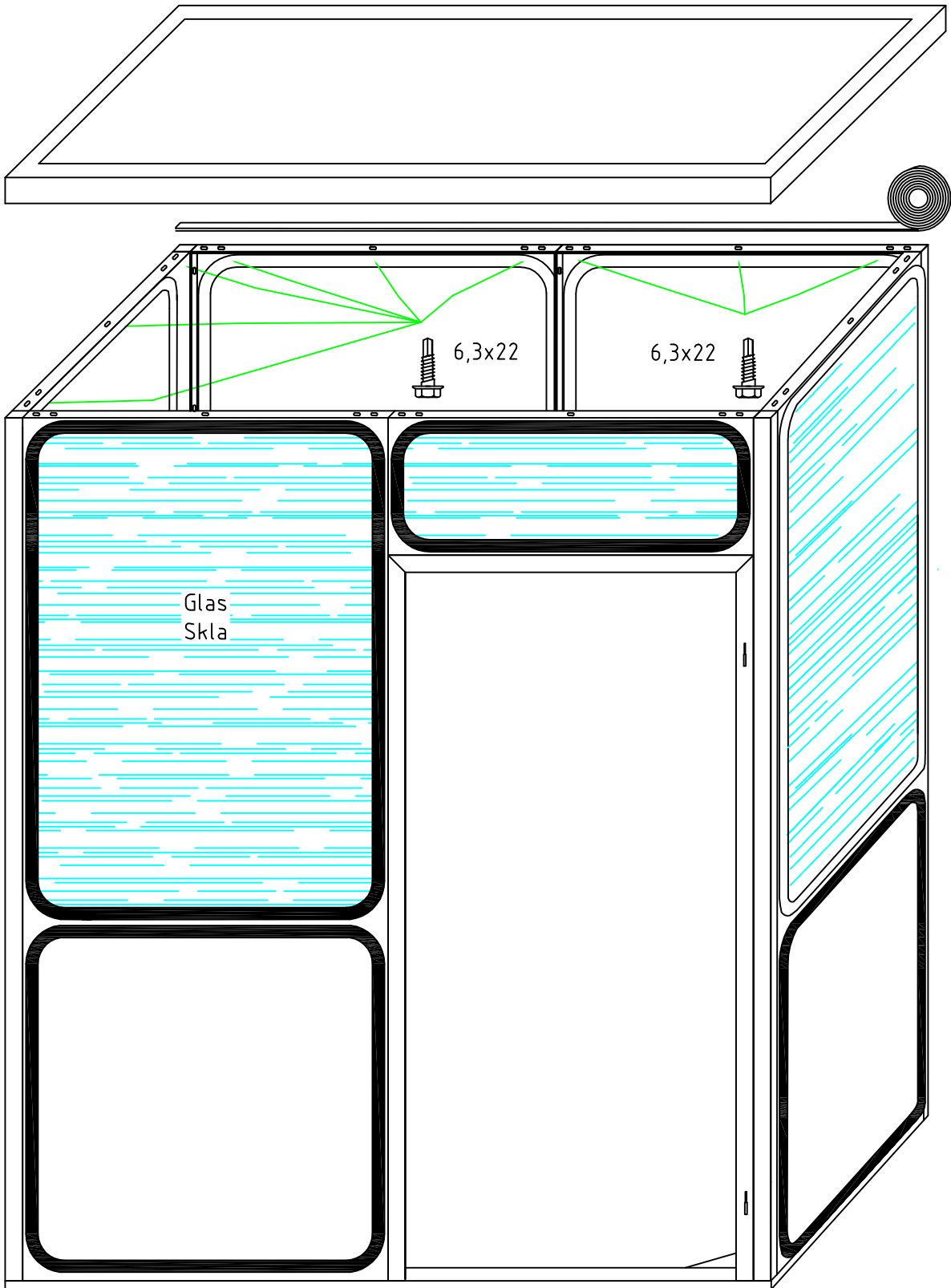

Abbildung 6
Fig. 6

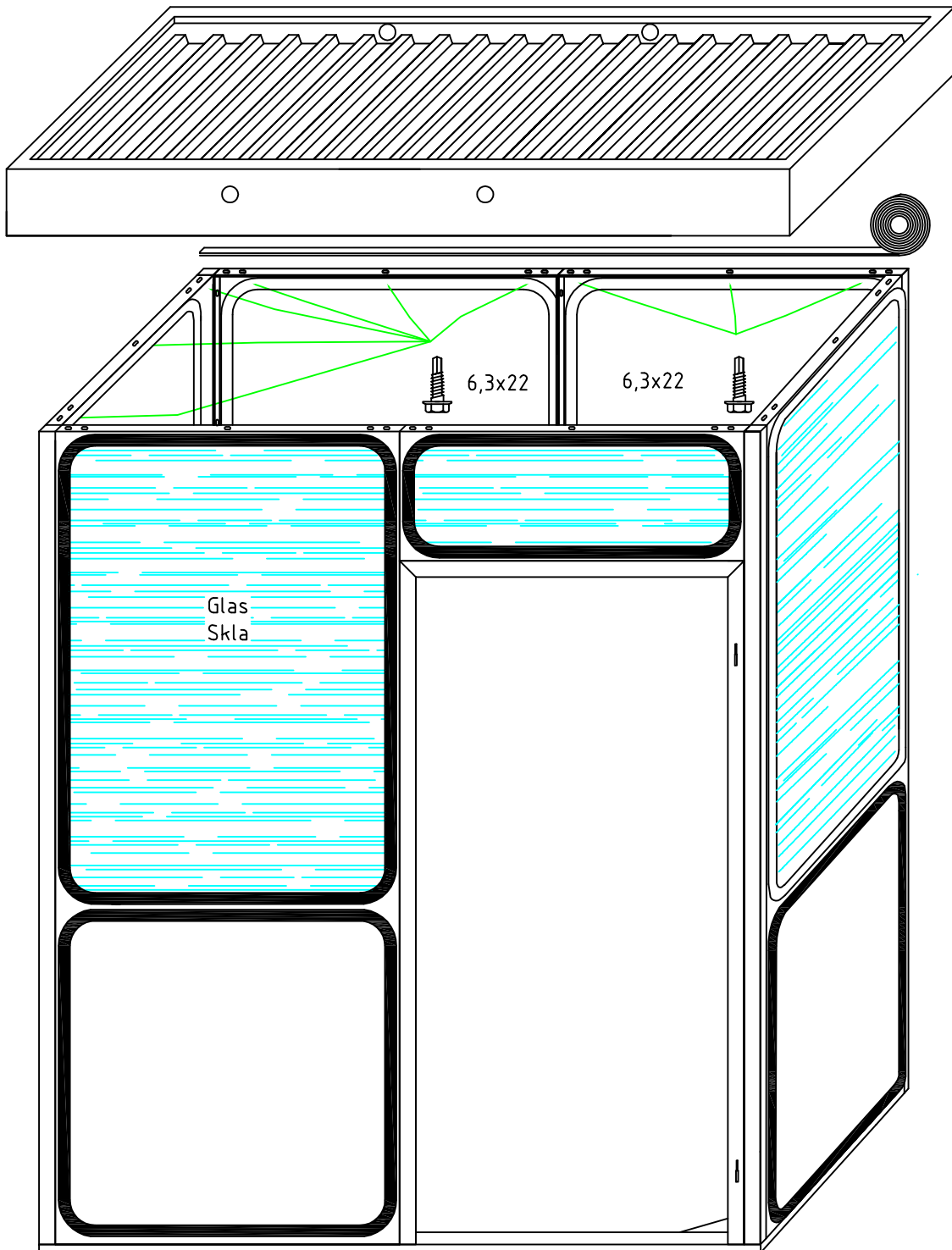

Abbildung 7
Fig. 7

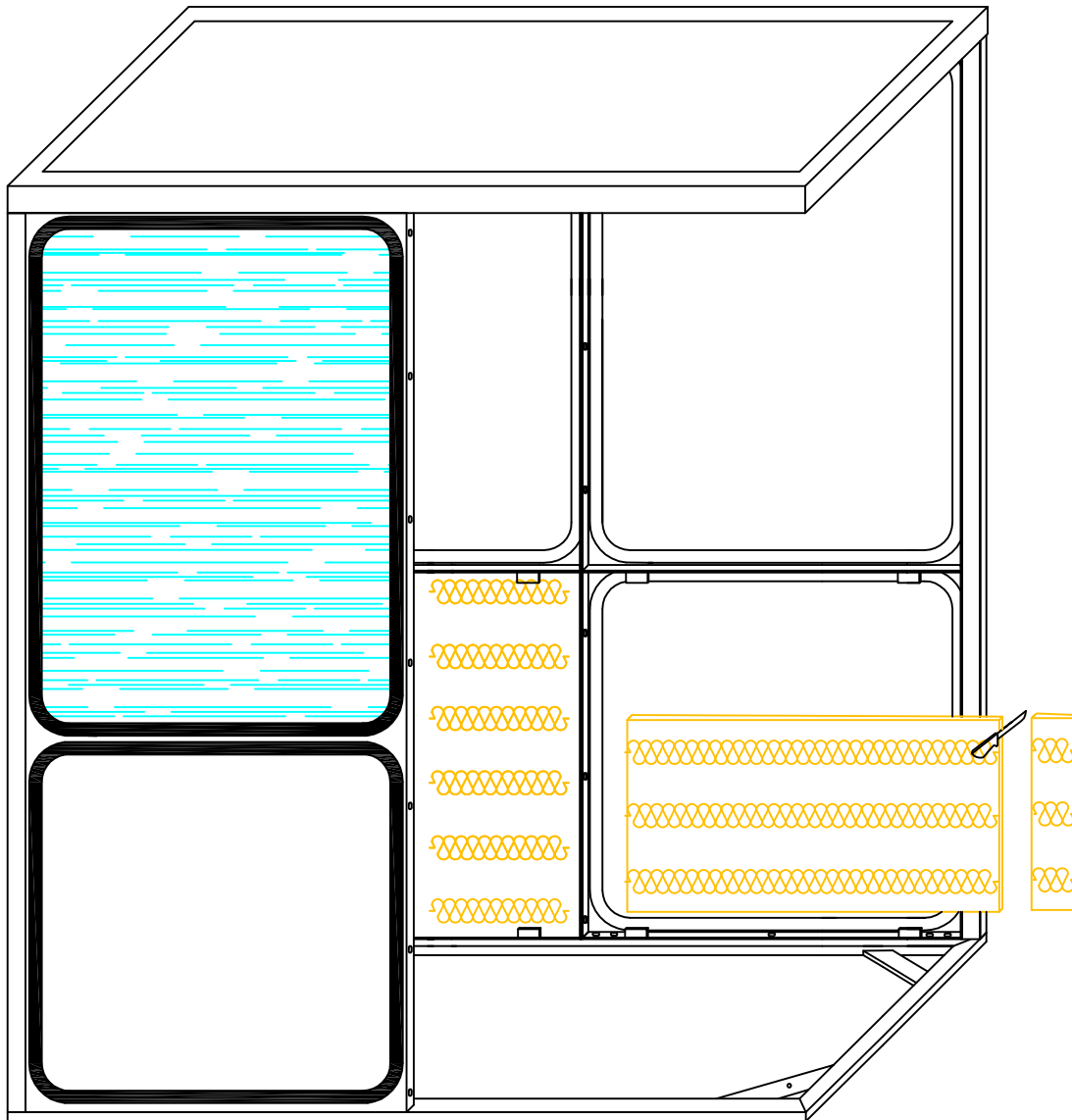

Abbildung 8.0
Fig. 8.0

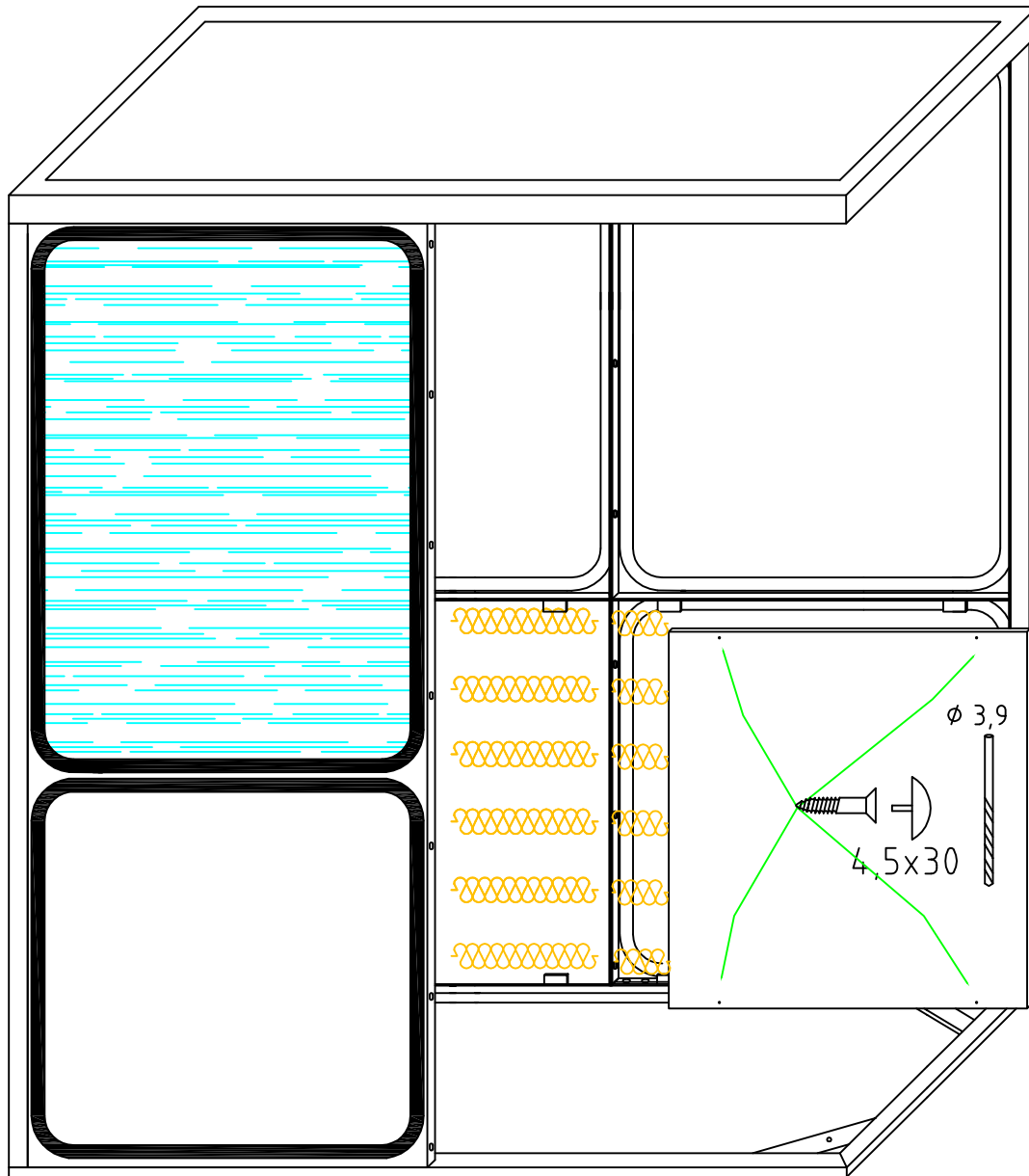

Abbildung 8.1
Fig. 8.1

Instrukcja montażową

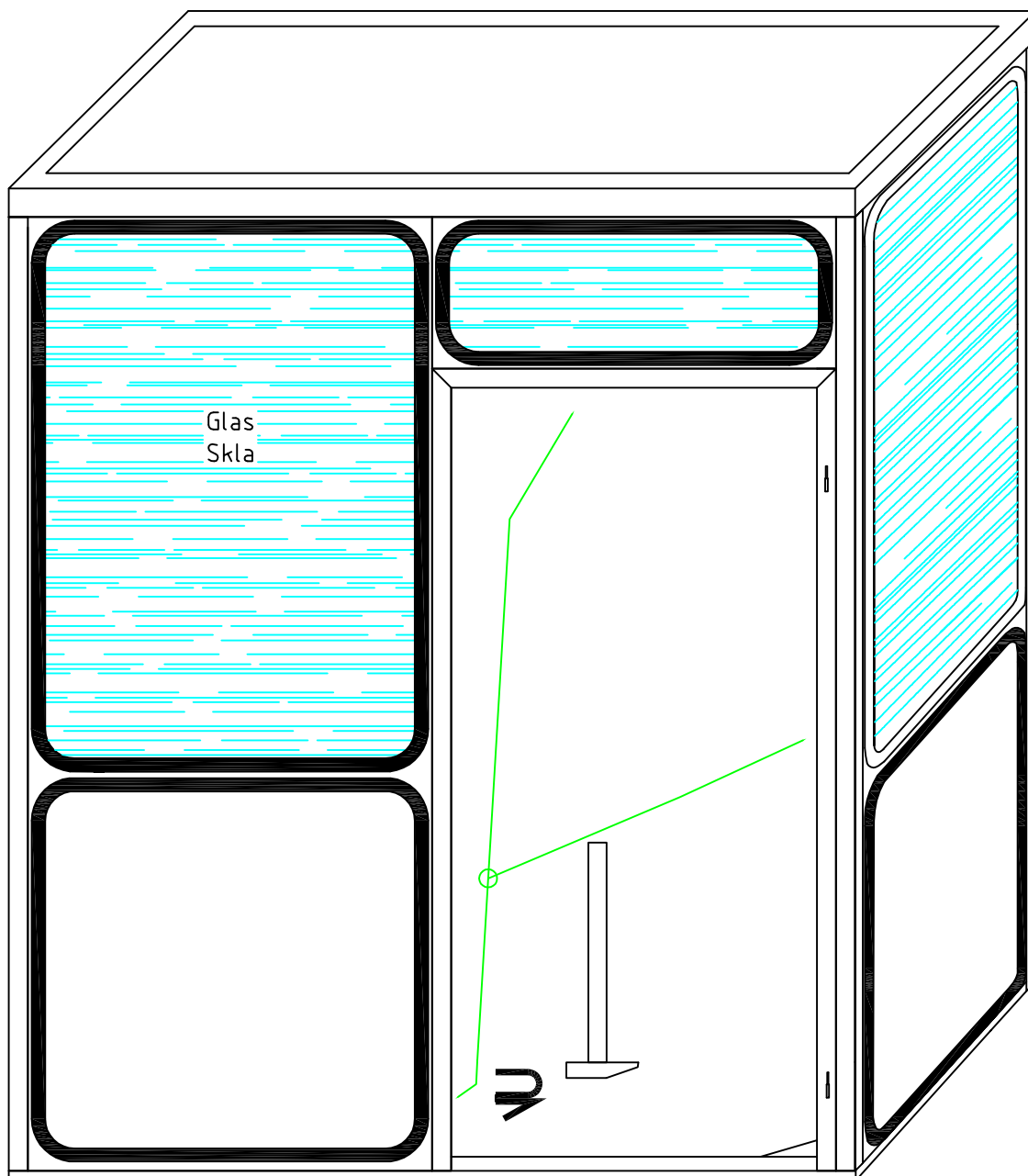
Budynki uniwersalne
Wersja z zaokrąglonymi
narożnikami
Typ MR

Opcje:
Podłoga
Okladzina wewnętrzna

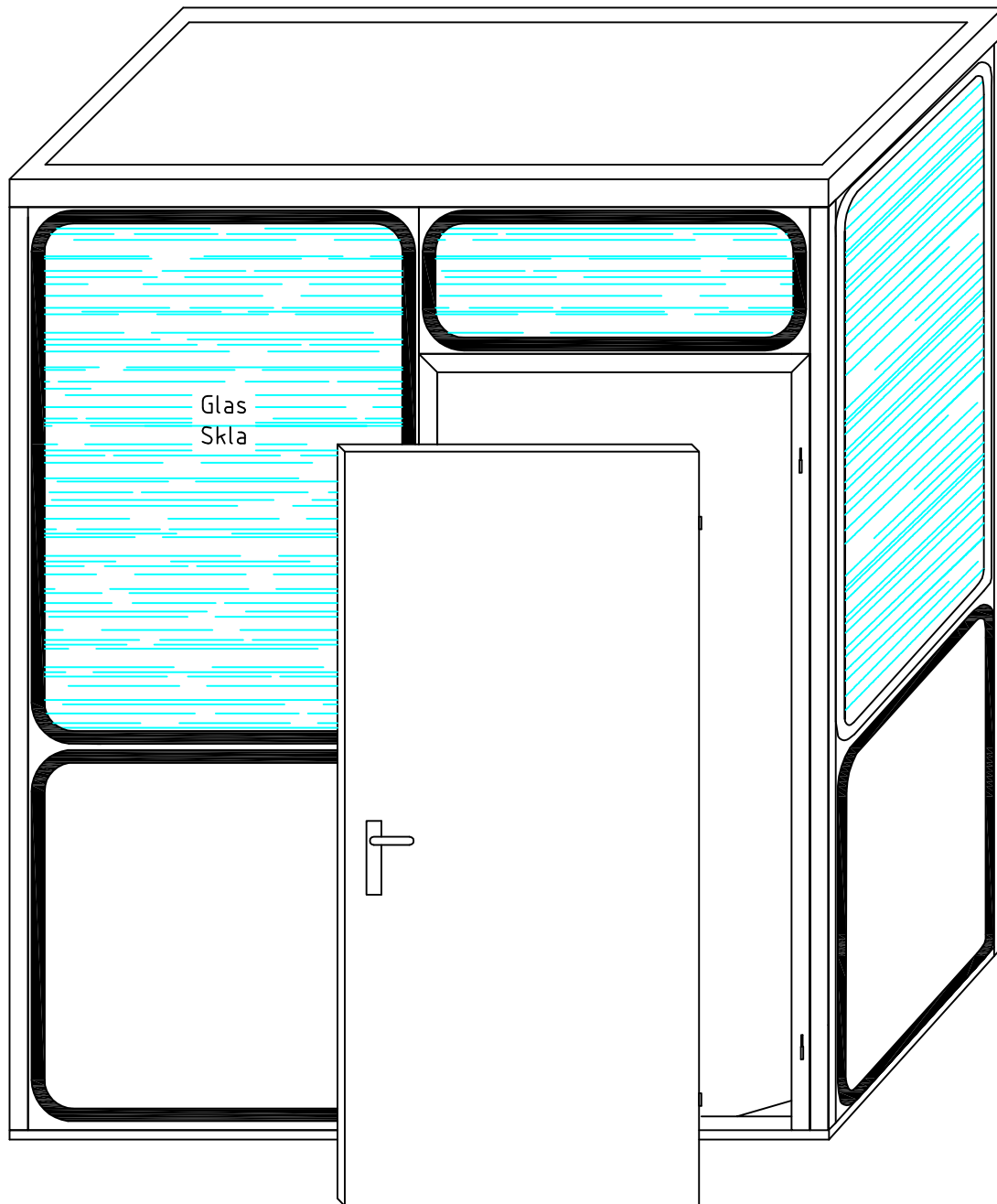
Instrukcją montażową

System modułarny pomieszczeniowy



1. Ustawić ramę podłogową (Opcja podłoga lub Rama montażowa). (Fig. 1)
2. Do ramy rurowej przykleić taśmę uszczelniającą. (Fig. 1)
3. Taśmę uszczelniającą przykleić do podłużnych stron elementów dachowych. (Fig. 2)
4. Słup narożny przyśrubować przy pomocy wkrętów do blach do elementu ściennego. (Fig. 2)
5. Element ścienny wraz ze słupem narożnym postawić na ramie podłogowej i zaśrubować przy pomocy wkrętów do blach. (Fig. 3)
6. Elementy ścienne, słupy i drzwi ustawić obok siebie i zaśrubować. (Fig. 4.0 – 4.2)
7. Taśmę uszczelniającą nakleić na górną stronę elementów ściennych. (Fig. 5.0 – 5.1)
8. Nałożyć ramę dachową i zaśrubować z elementami ściennymi. Używać wkręty do blach. Wersja do ustawienia wewnątrz (Fig. 5.0) – na zewnątrz (Fig. 5.1)
9. Do montażu w drzwiach. (Fig. 8.0 – 8.1)

Opcja – Okładzina wewnętrzna

10. Wełnę żużlową o grubości 40 mm postawić od wewnątrz przy blachach. (Fig. 6)
11. Płytę wiórową o grubości 13 mm przyśrubować przy pomocy wkrętu z łbem Wpuszczanym o wym. 4,5 x 30. Kapy wcisnąć w gniazdko wkrętów. (Fig. 7)
12. Listwę przyścienną przybić gwoździami.



Zmiany w projekcie są zarezerwowane.



Abbildung 1
Fig. 1



Abbildung 2
Fig. 2

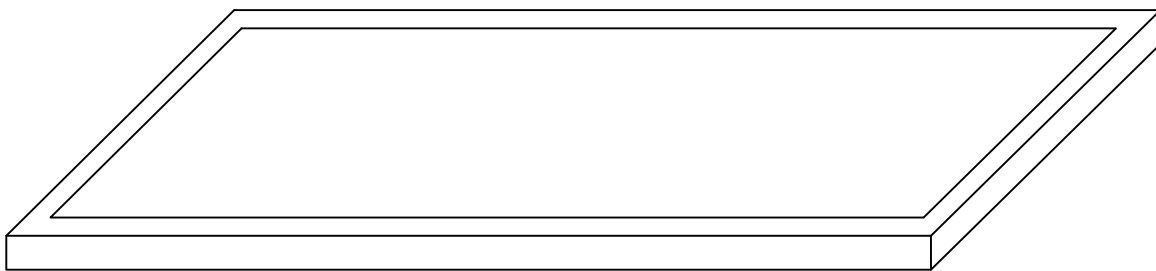
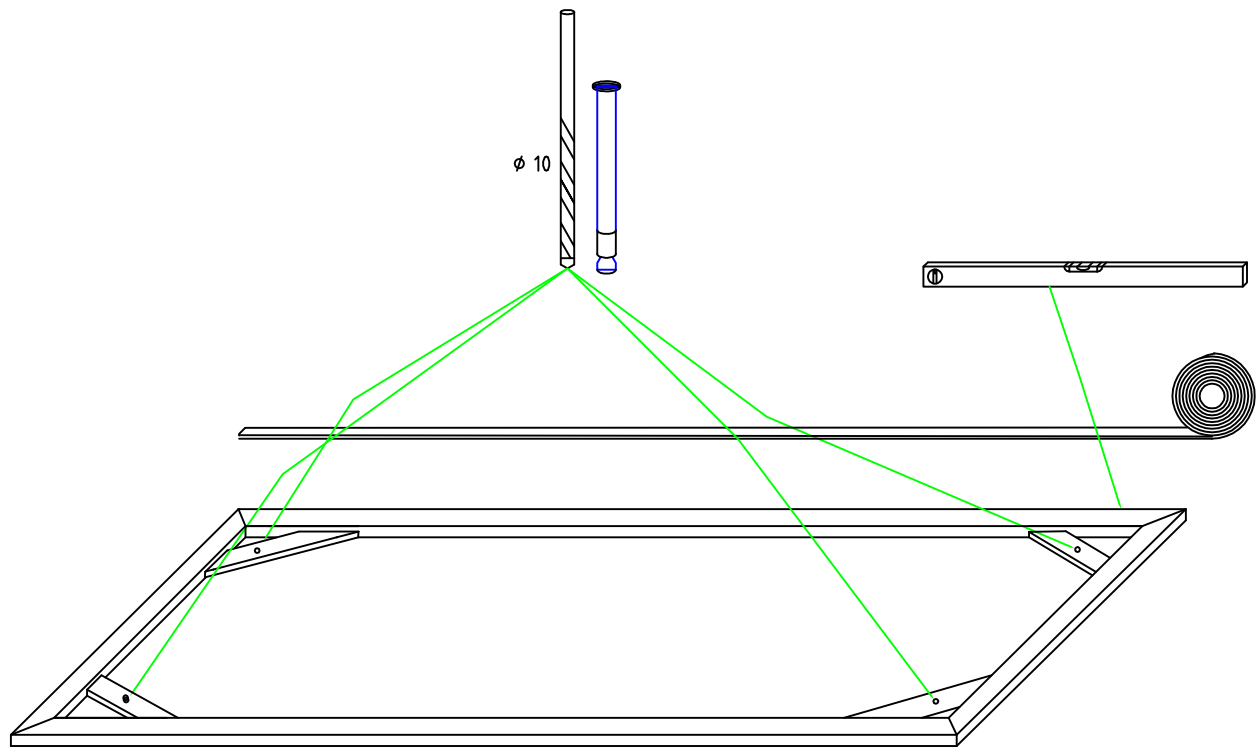

Abbildung 3
Fig. 3

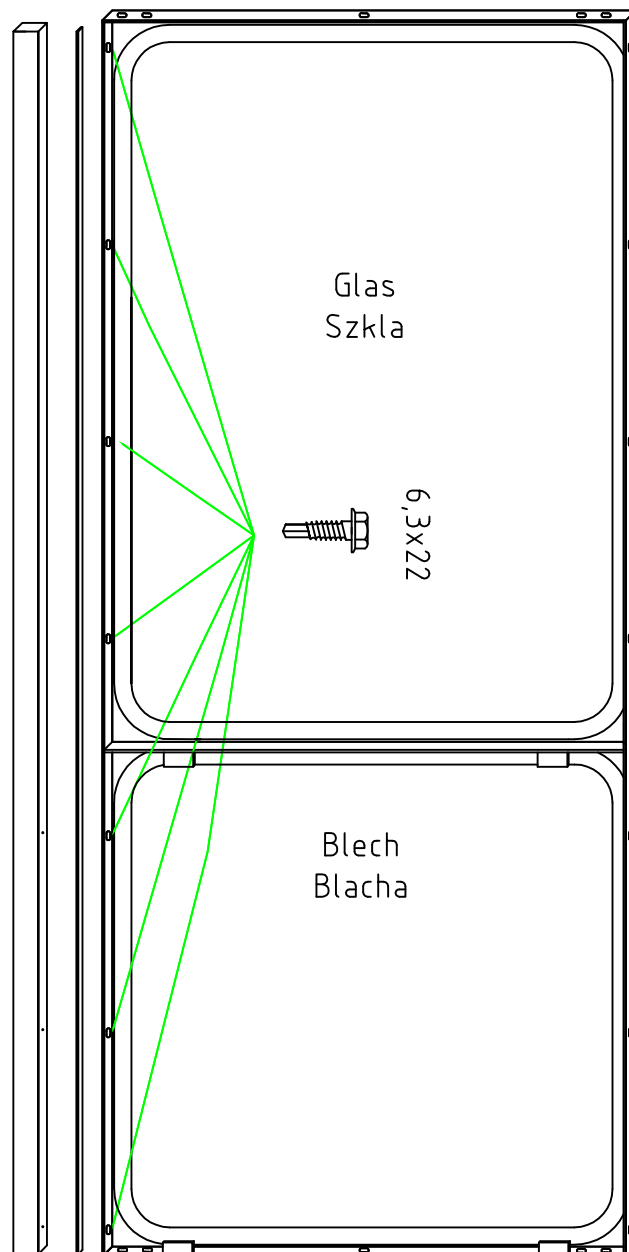

Abbildung 4.0
Fig. 4.0

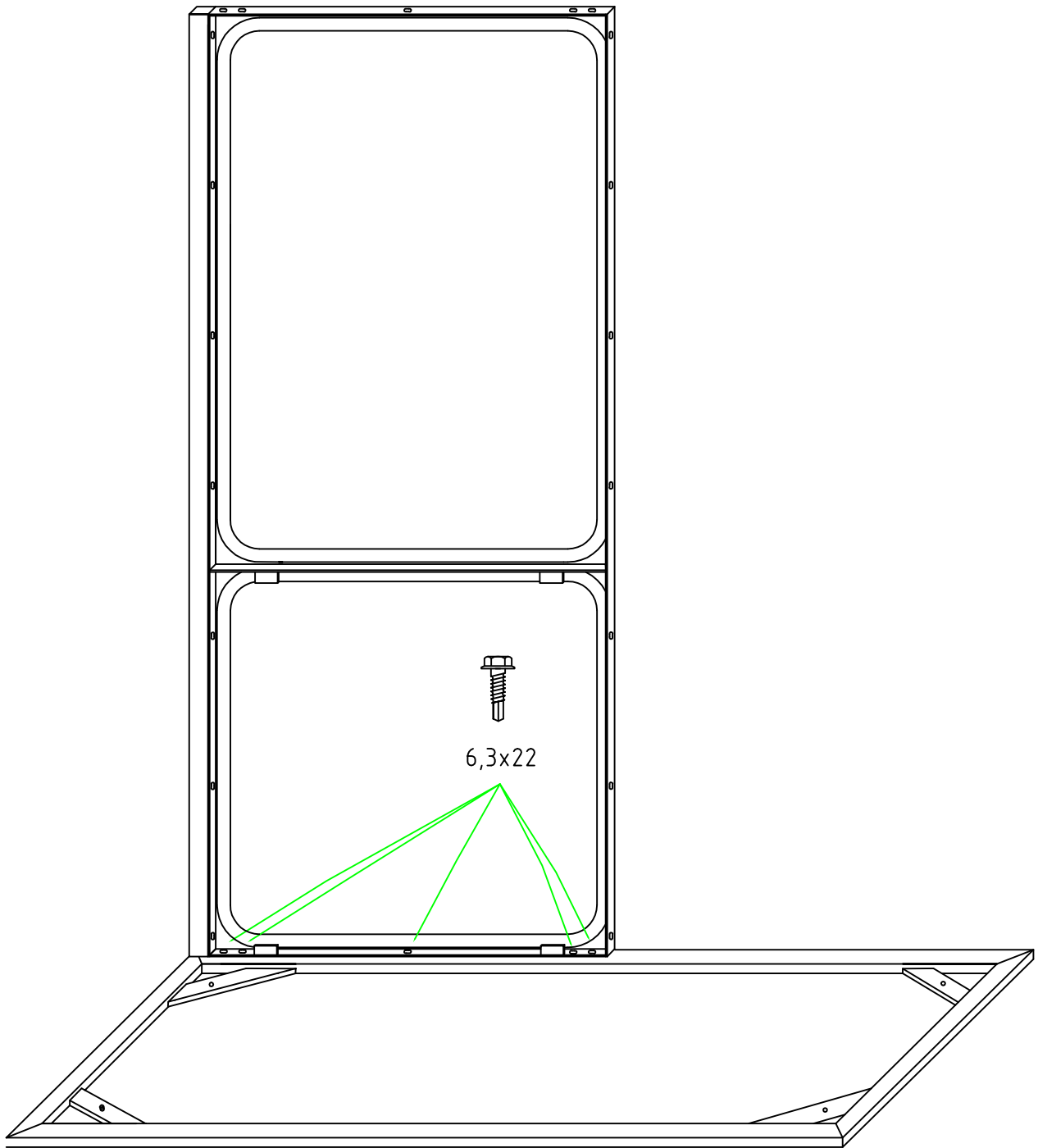

Abbildung 4.1
Fig. 4.1

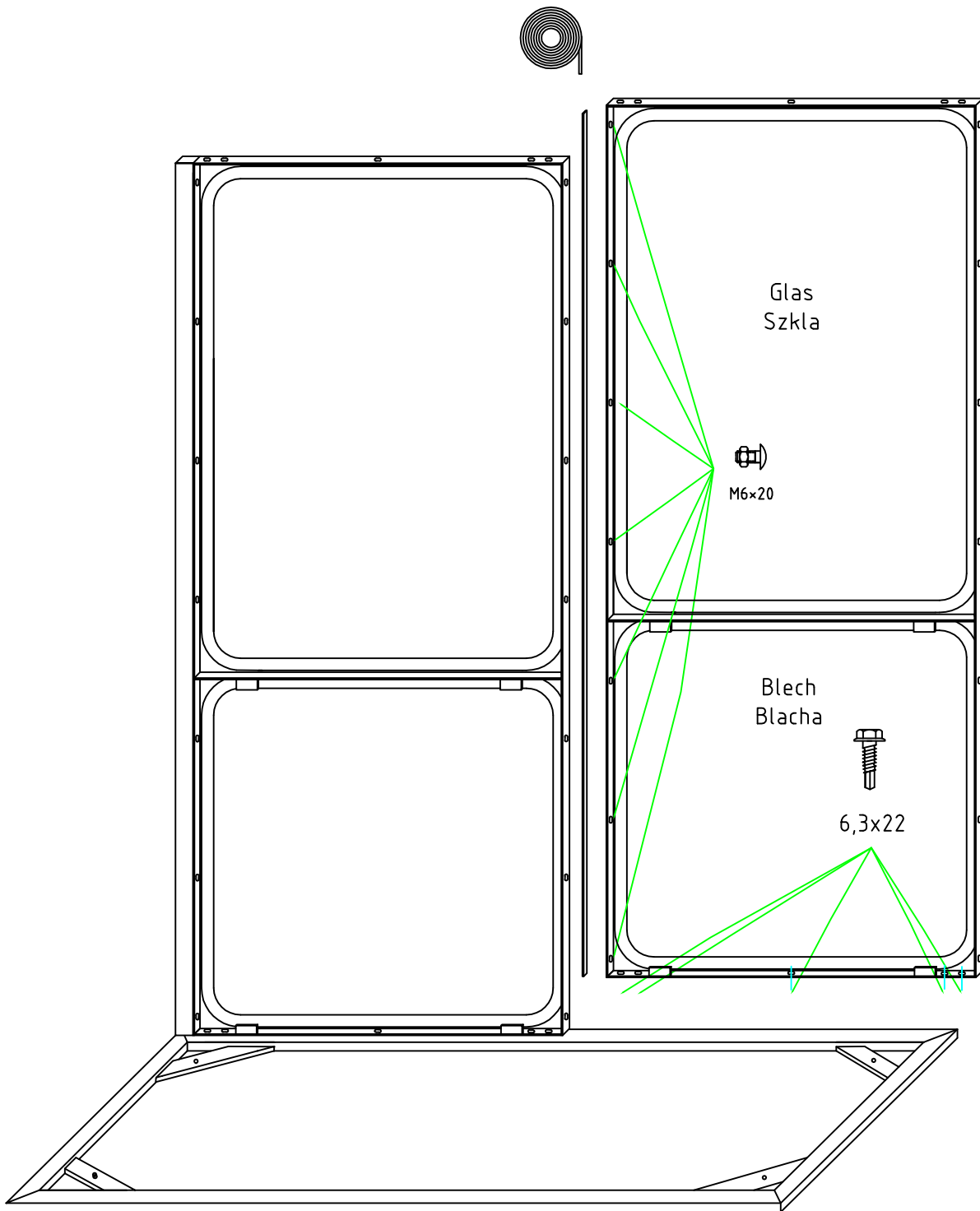

Abbildung 4.2
Fig. 4.2

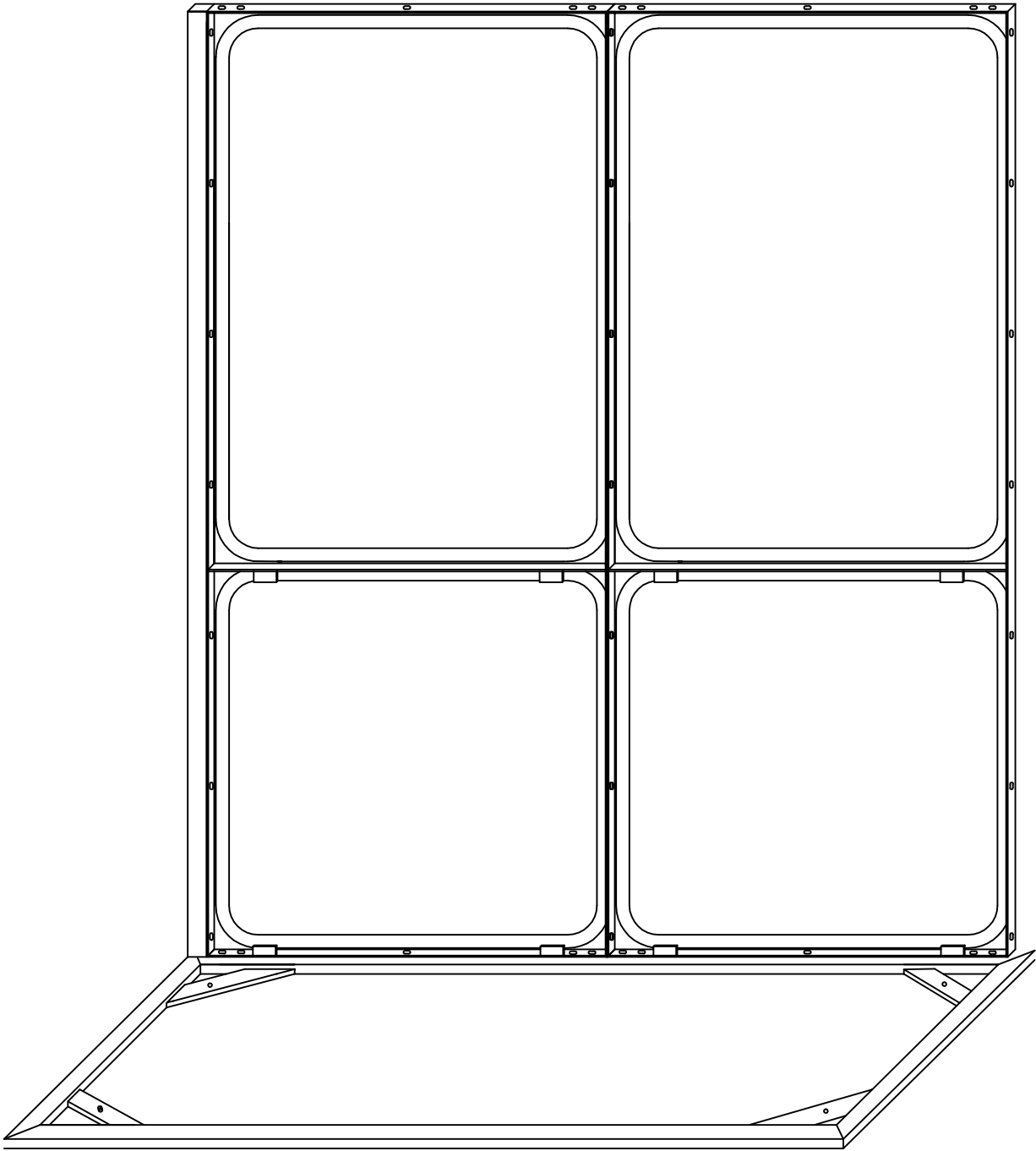

Abbildung 5.0
Fig. 5.0

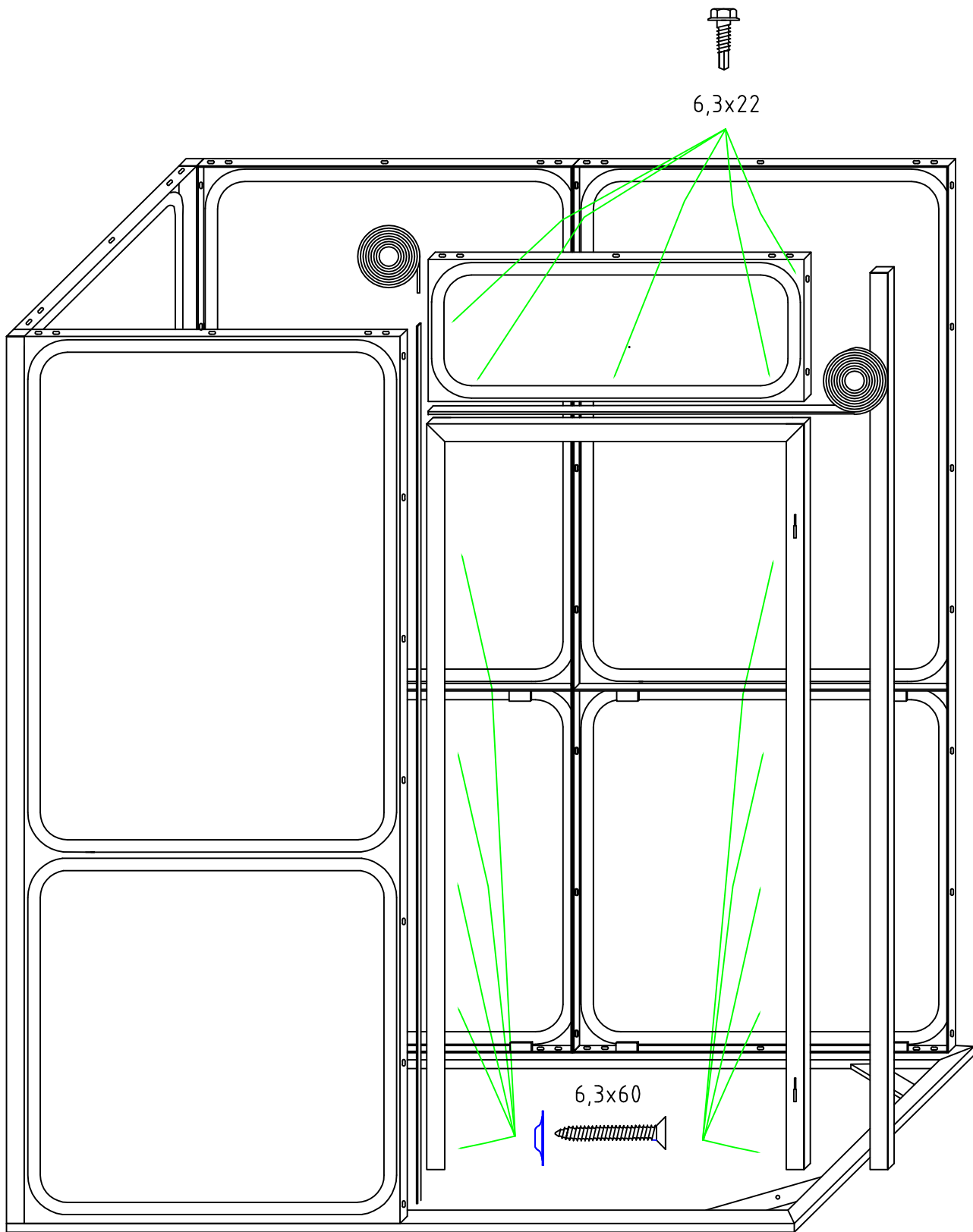

Abbildung 5.1
Fig. 5.1

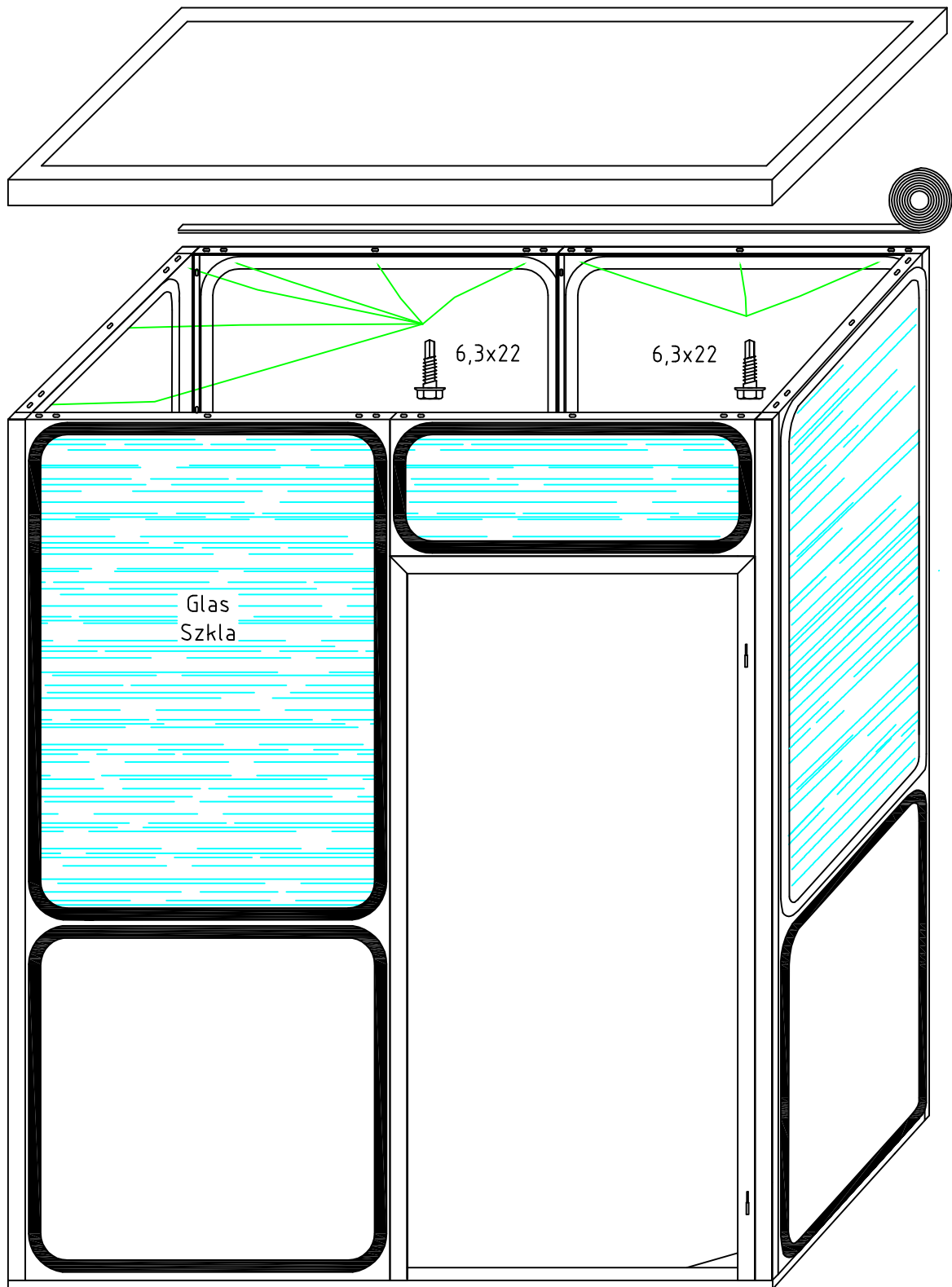

Abbildung 6
Fig. 6

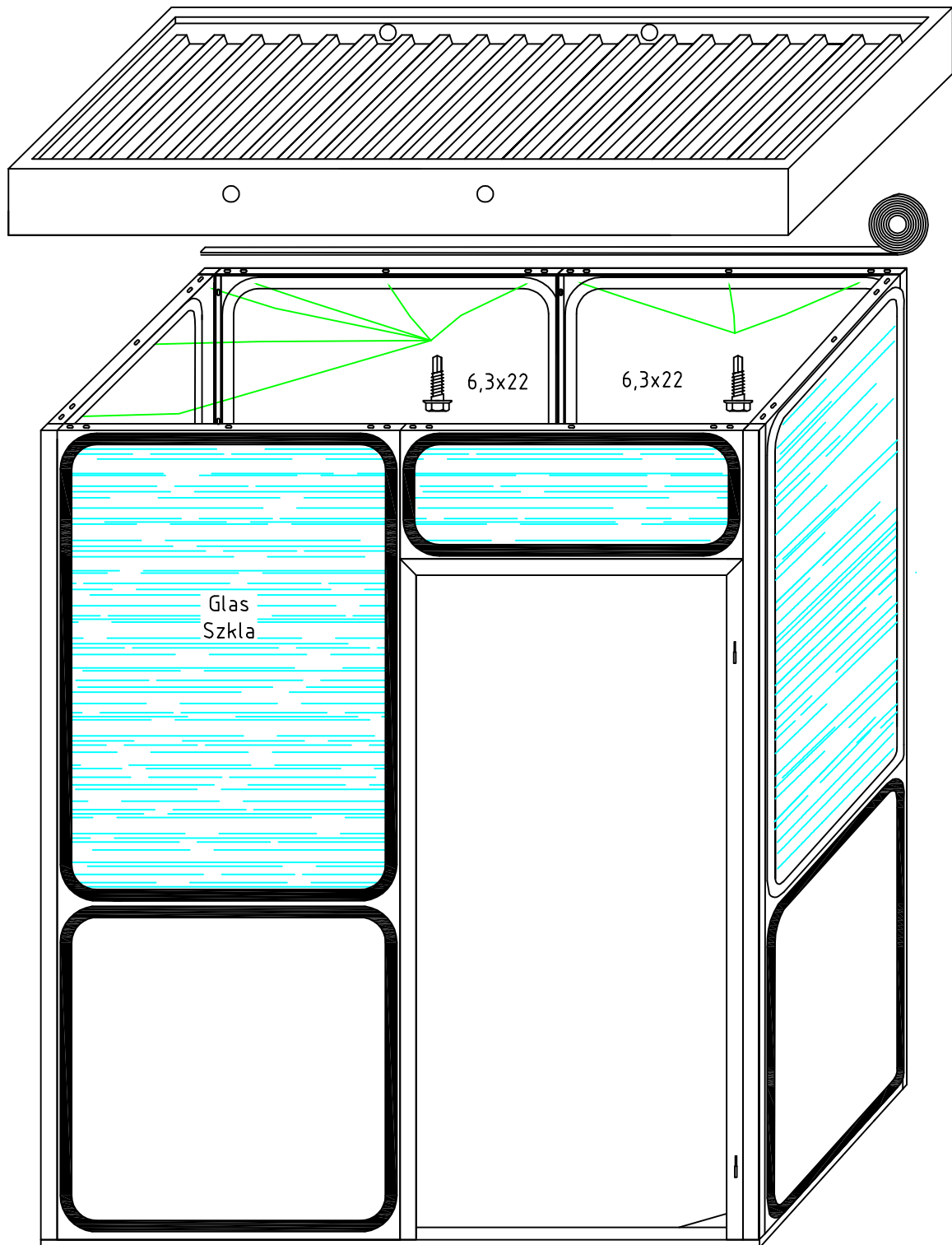

Abbildung 7
Fig. 7

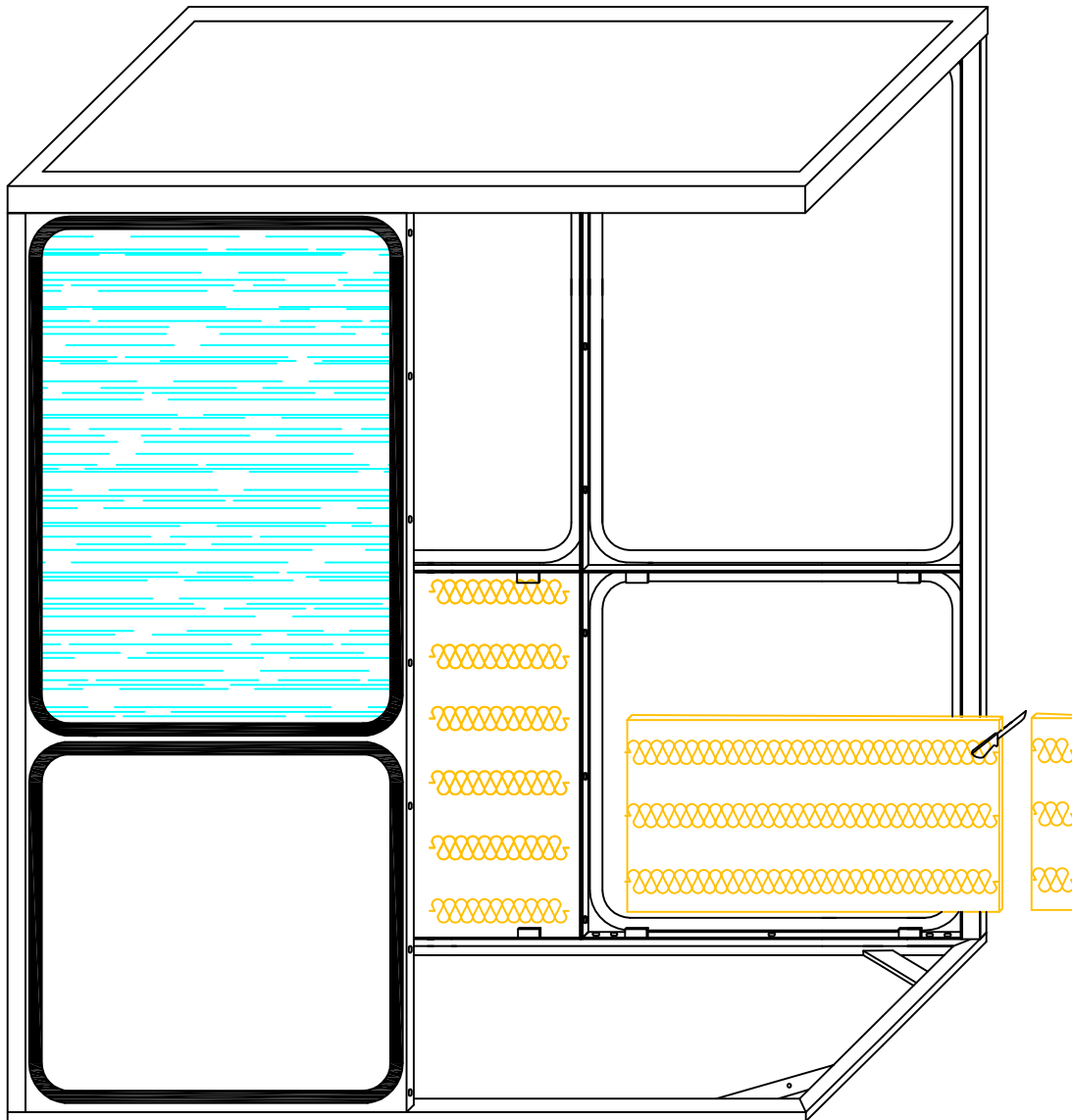

Abbildung 8.0
Fig. 8.0

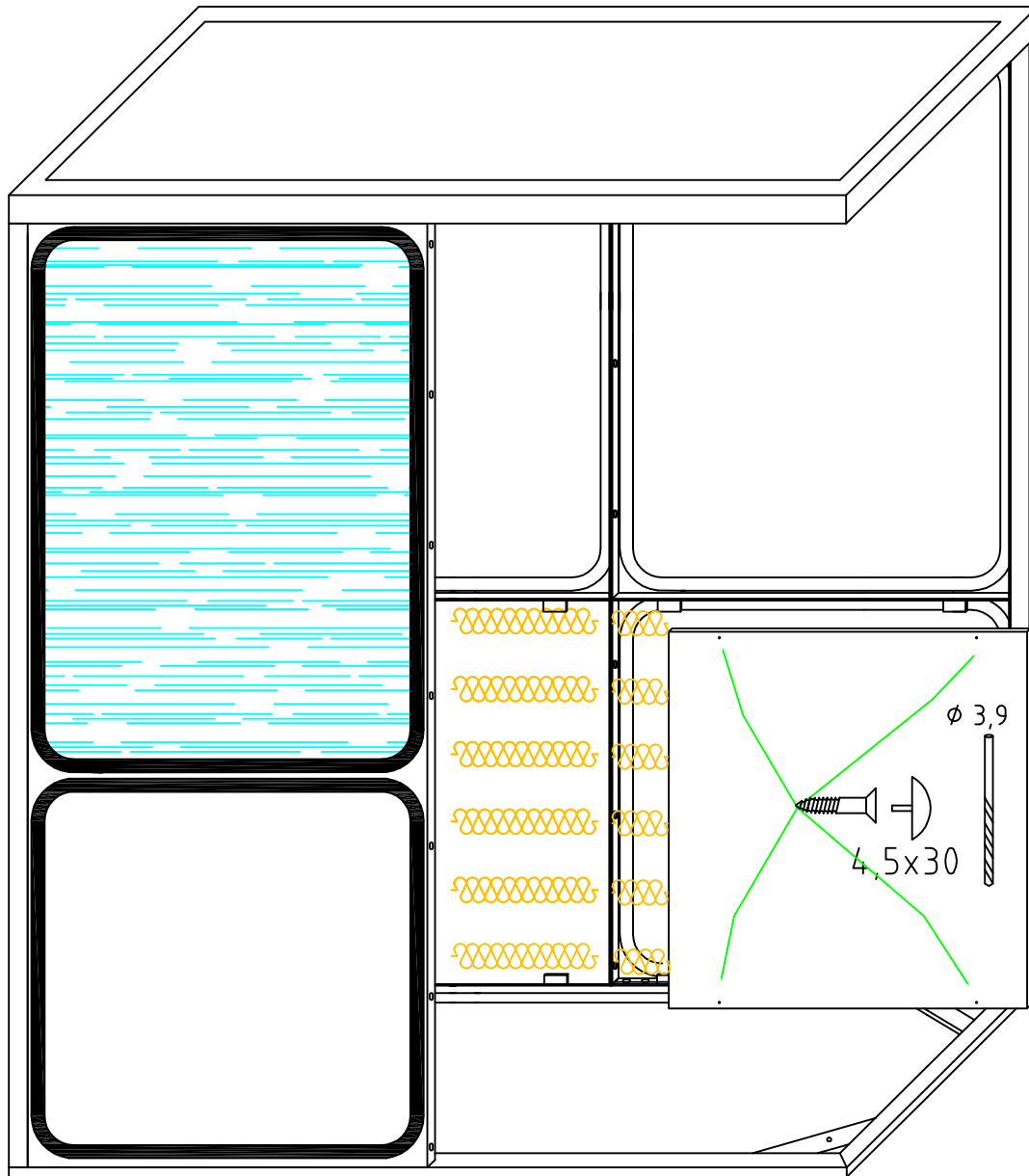

Abbildung 8.1
Fig. 8.1

Az összeszerelés leírása

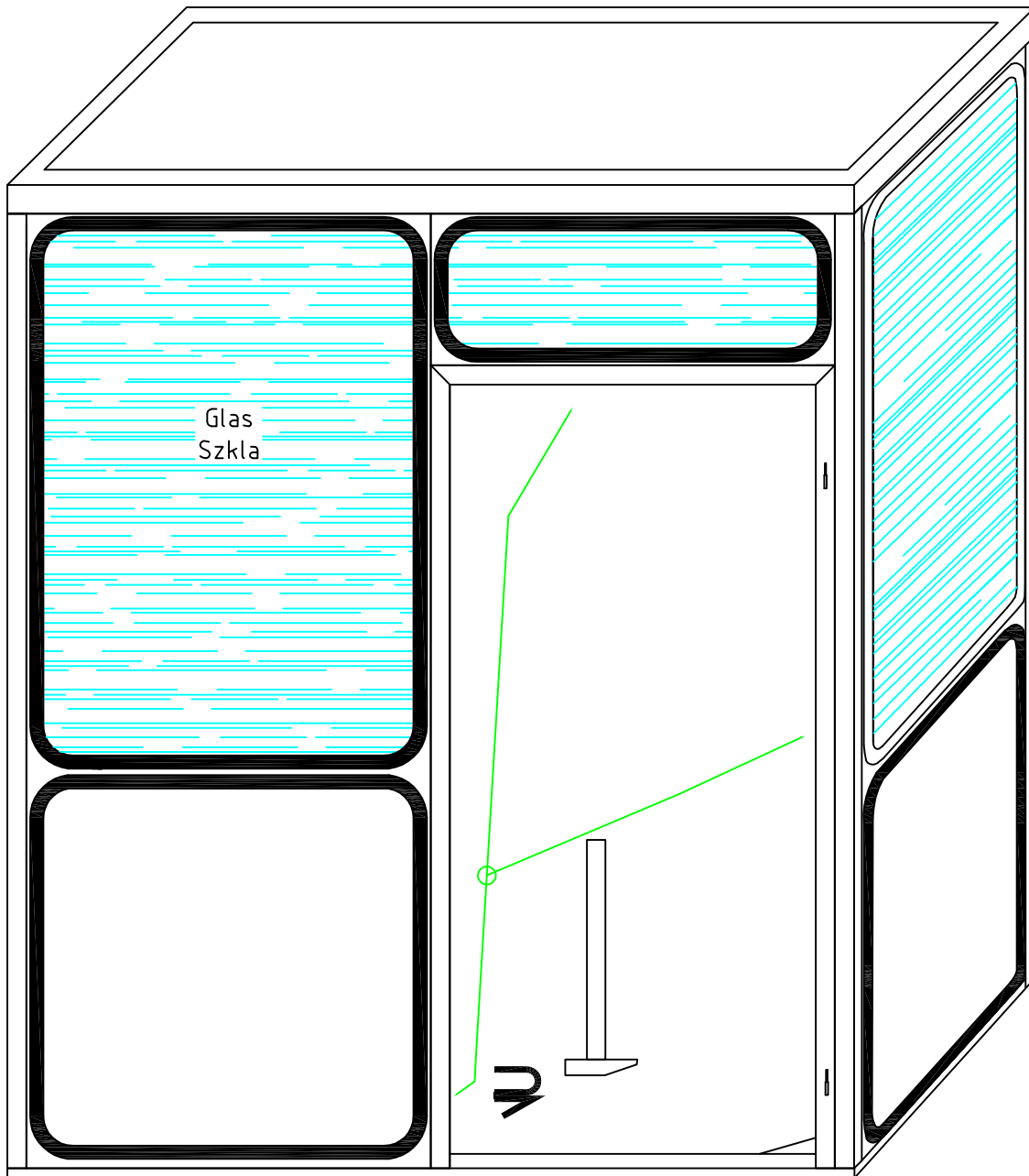
Univerzális házak
Lekerekített sarkos kivitel
Típus MR

Opciók:
Padló
Belső burkolat

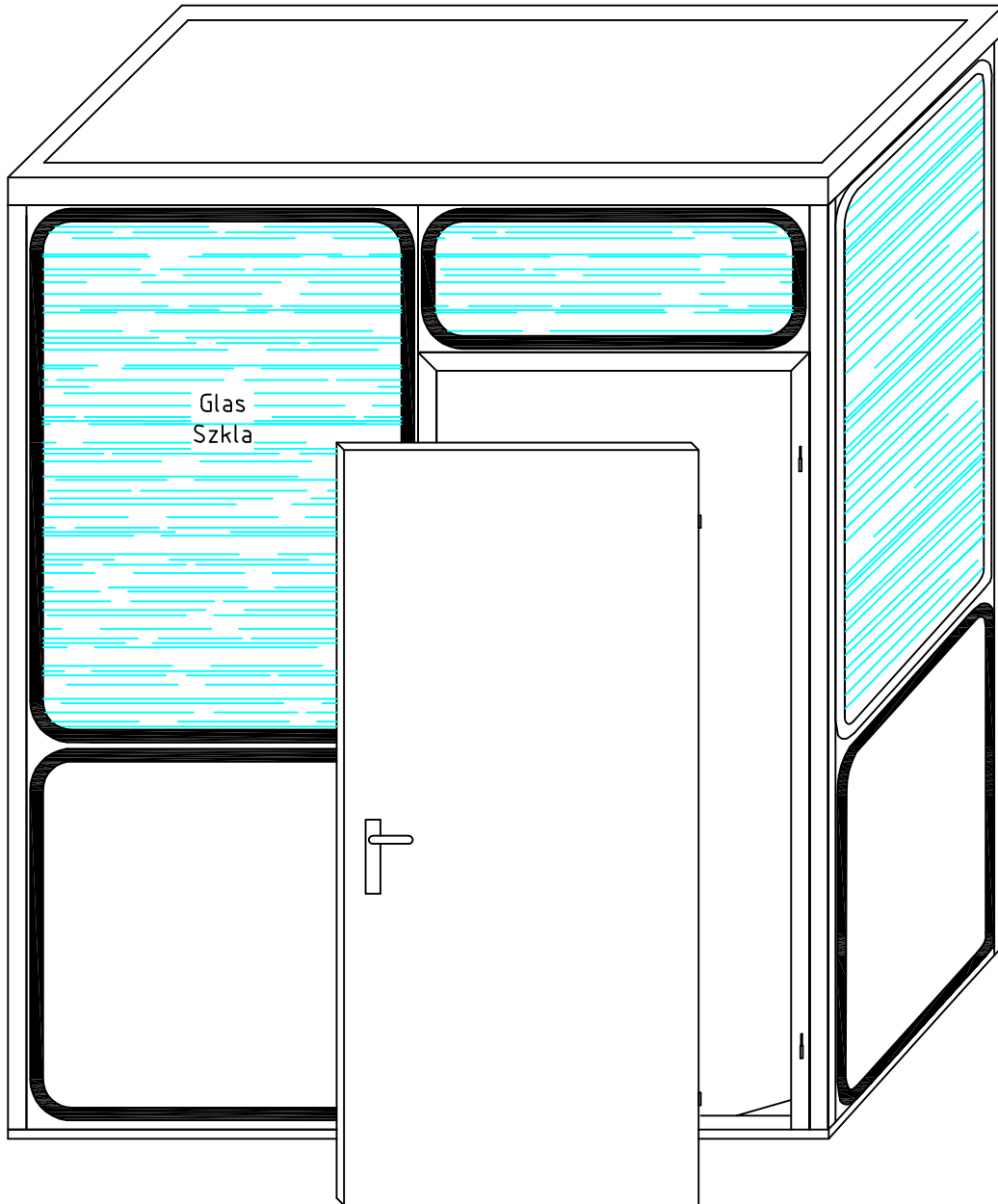
Az összeszerelés leírása

Moduli térrendszer

1. Kiigazítani a padlókeretet (opciók padló vagy szerelőkeret). (Fig. 1)
2. Ragasztani tömítő szalagot a csökeretre. (Fig. 1)
3. Ragasztani tömítő szalagot a tető elemeinek hosszoldalára. (Fig. 2)
4. Odacsavarni a sarokgerendákat lemezcsavarokkal a fali elemekhez. (Fig. 2)
5. Rakni a fali elemet a sarokgerendákkal a padlókeretre és összezsavarni lemezcsavarokkal. (Fig. 3)
6. Egymáshoz helyezni fali elemeket, gerendákat és ajtókat és összezsavarni. (Fig. 4.0 – 4.2)
7. Ragasztani tömítő szalagot a fali elemeinek felső oldalára. (Fig. 5.0 – 5.1)
8. Felrakni a padlókeretet és összezsavarni a fali elemekkel. Lemezcsavart használni. Beltéri használatra (Fig. 5.0) – Kültéri használatra (Fig. 5.1)
9. Ajtó mount. (Fig. 8.0 – 8.1)



Opciók – Belső burkolat

10. Odarakni 40 mm – es kögyapotot belülről a lemezekhez. (Fig. 6)
11. Odacsavarni 13 mm – es forgácslemezt 4,5 x 30 süllyesztettfejú csavarral. Benyomni a sapkákat a csavarok fejlyukaiba. (Fig. 7)
12. Odaszegezni a szegélylécet.



Tervezési változtatások joga fenntartva.



Abbildung 1
Fig. 1



Abbildung 2
Fig. 2

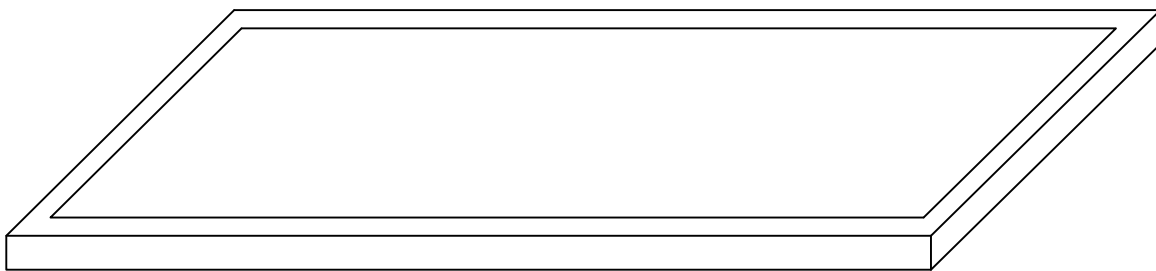
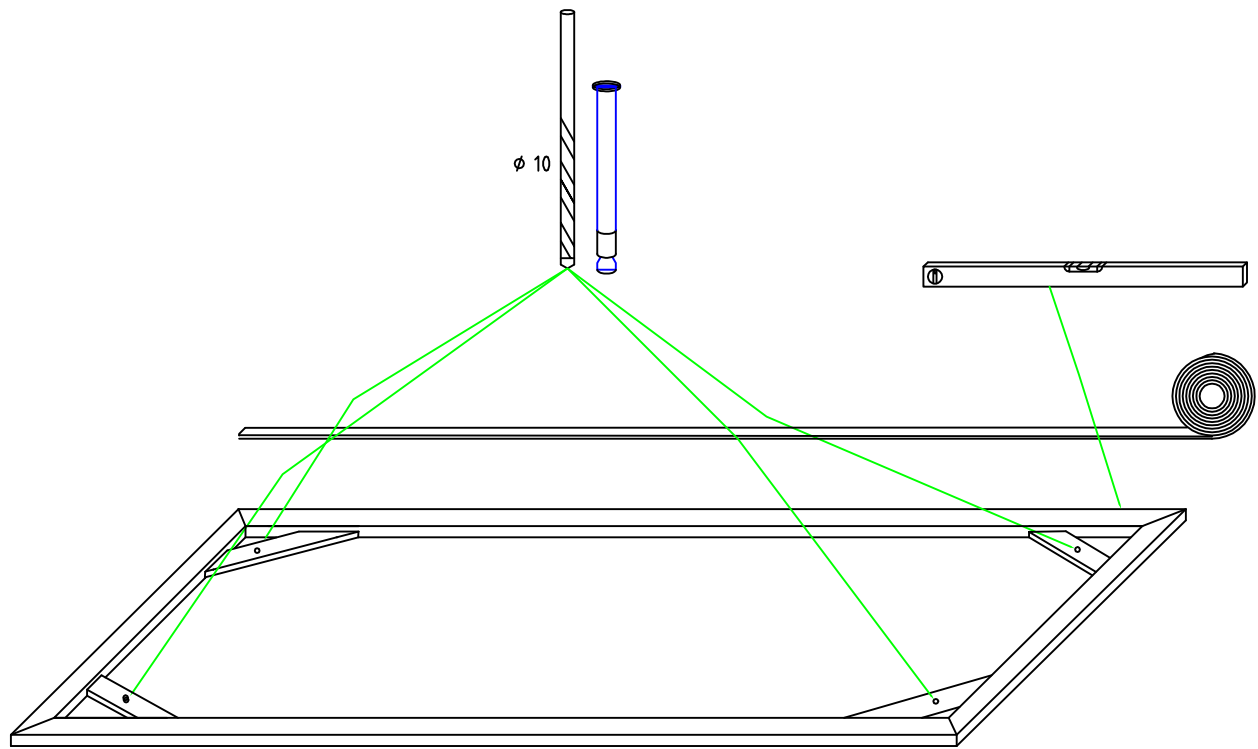

Abbildung 3
Fig. 3

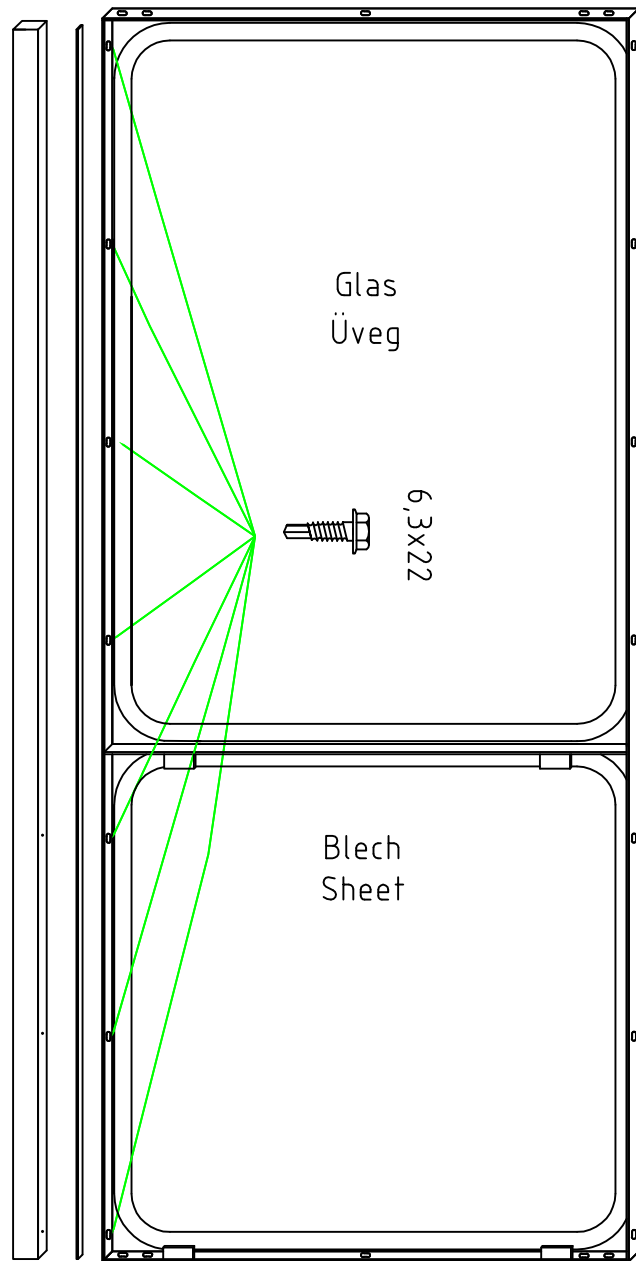

Abbildung 4.0
Fig. 4.0

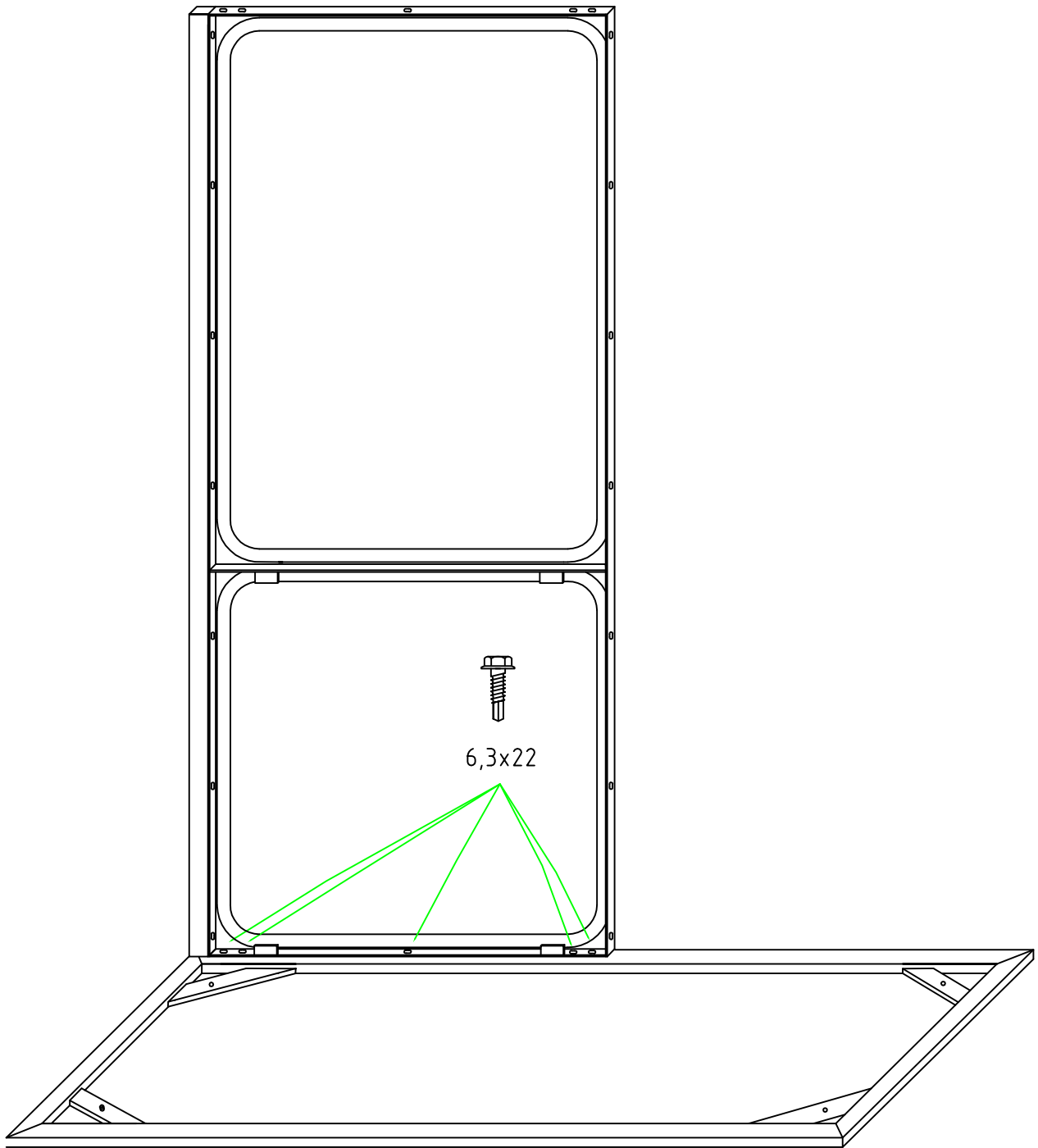

Abbildung 4.1
Fig. 4.1

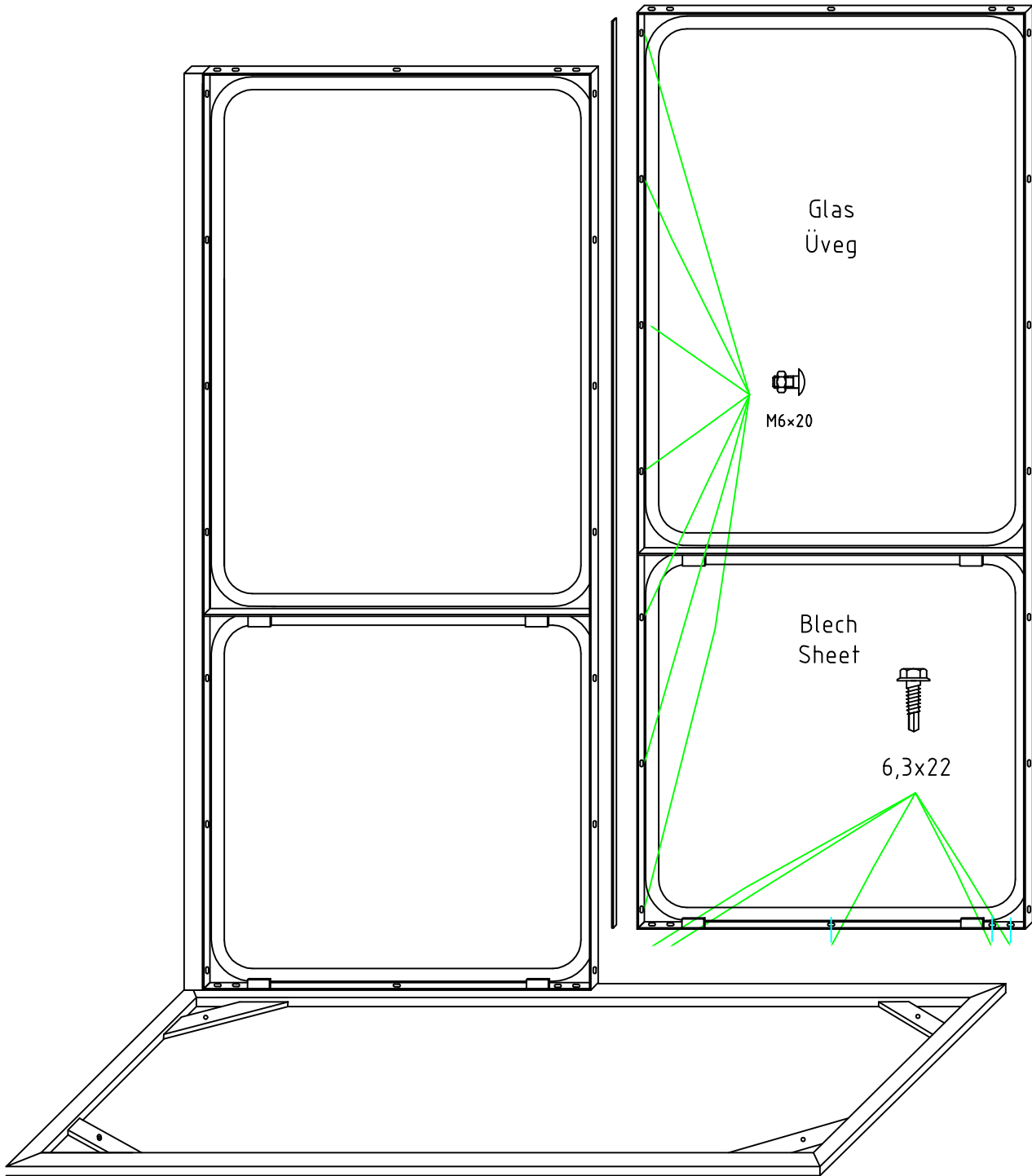

Abbildung 4.2
Fig. 4.2

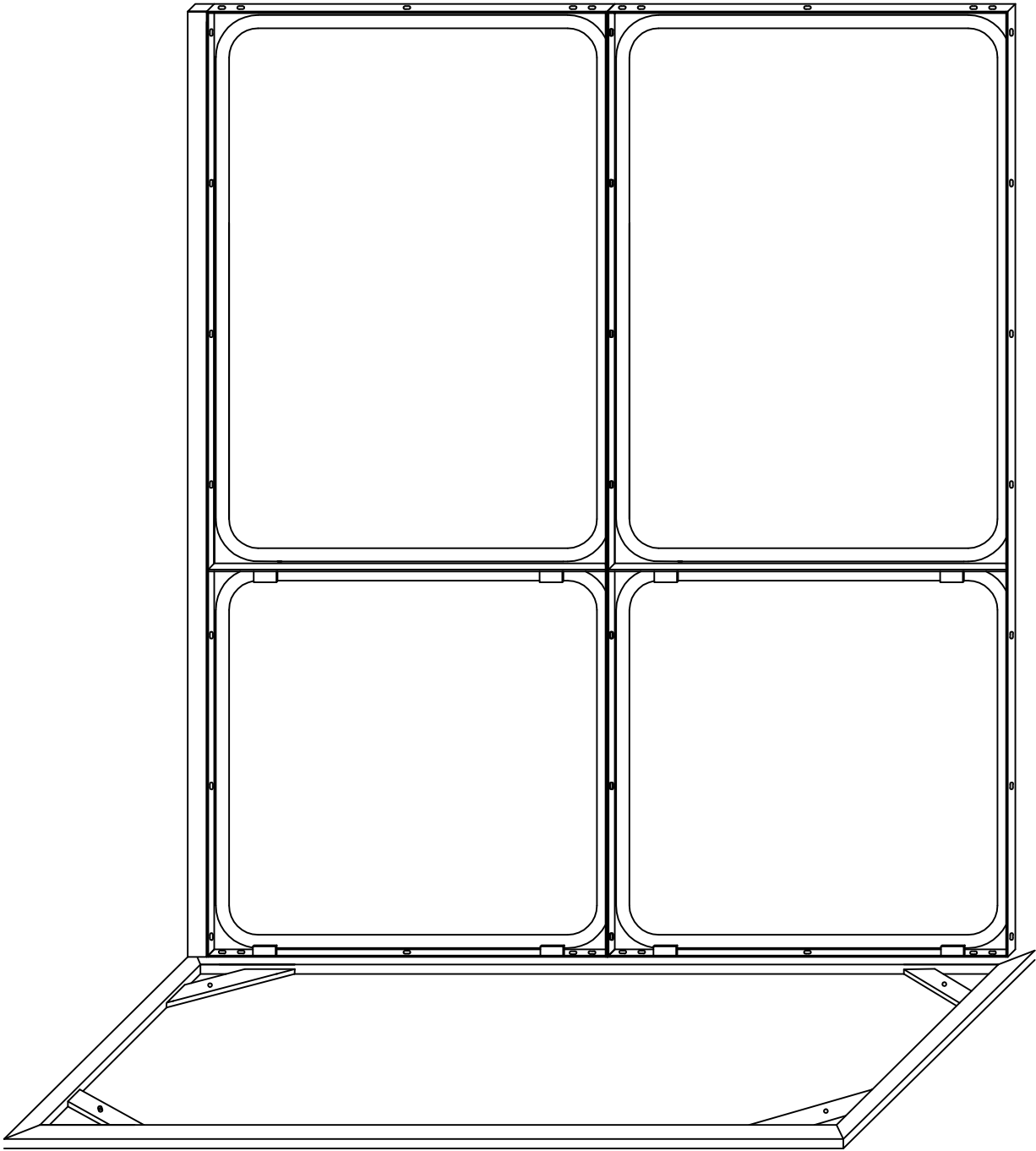

Abbildung 5.0
Fig. 5.0

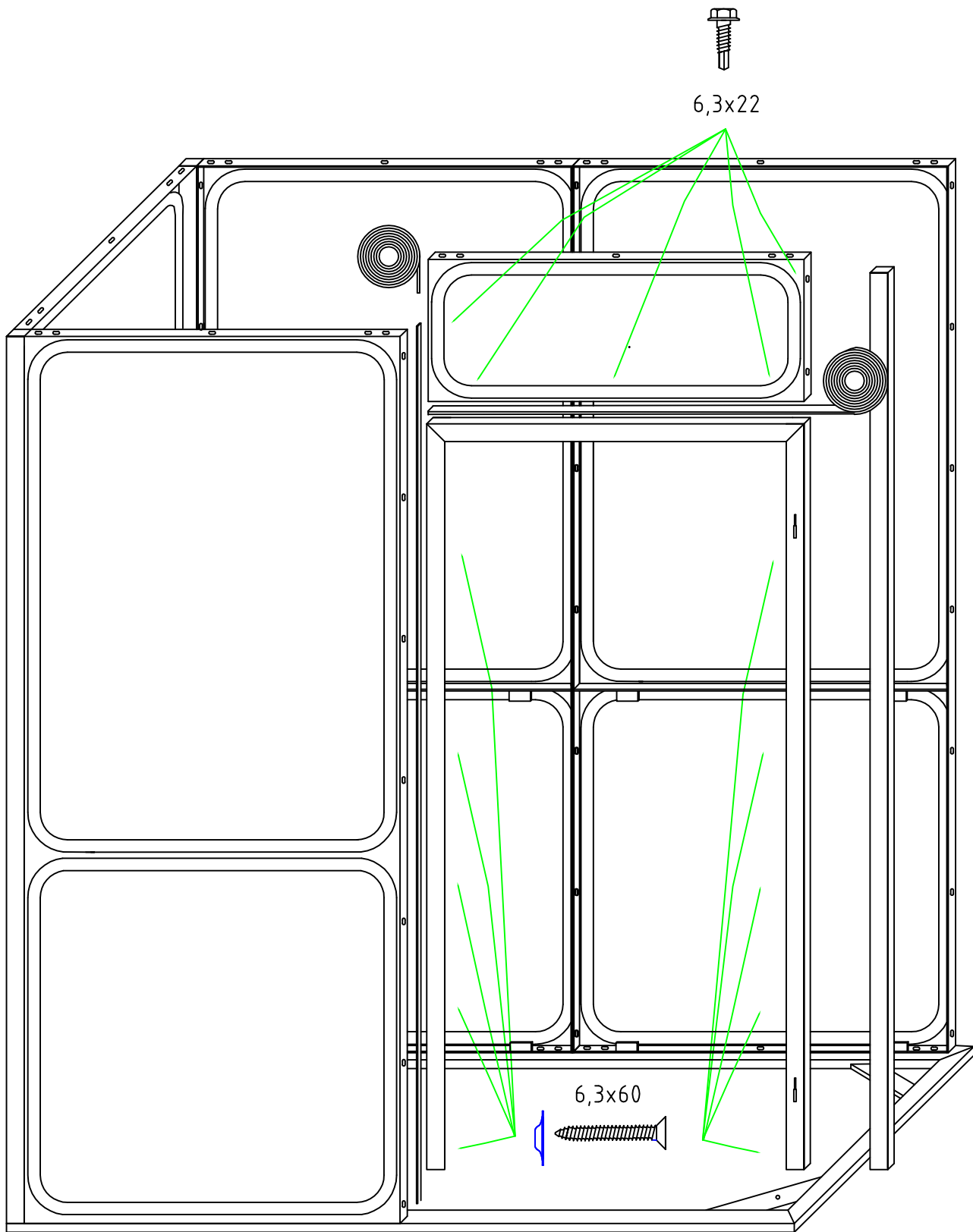

Abbildung 5.1
Fig. 5.1

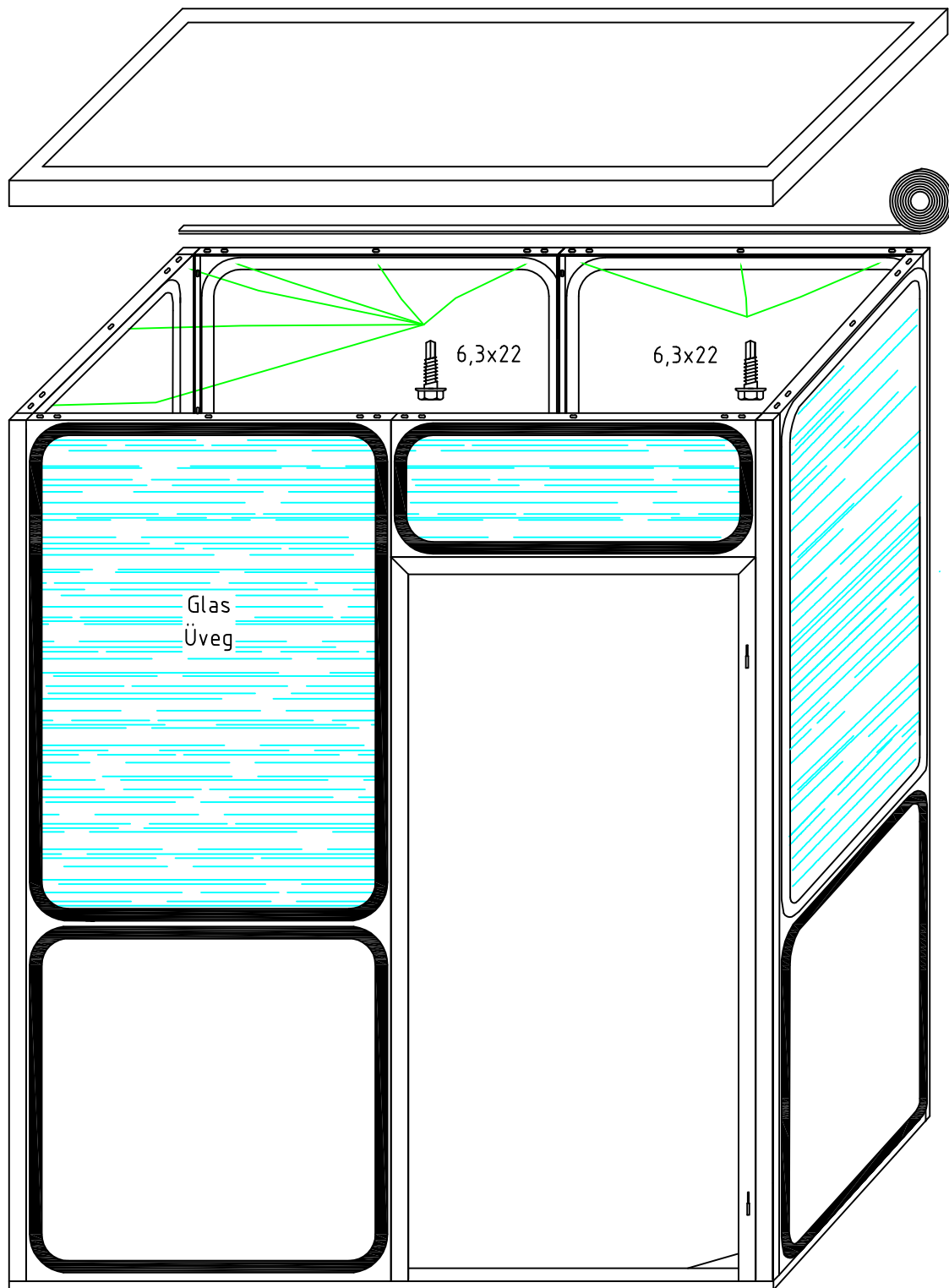

Abbildung 6
Fig. 6

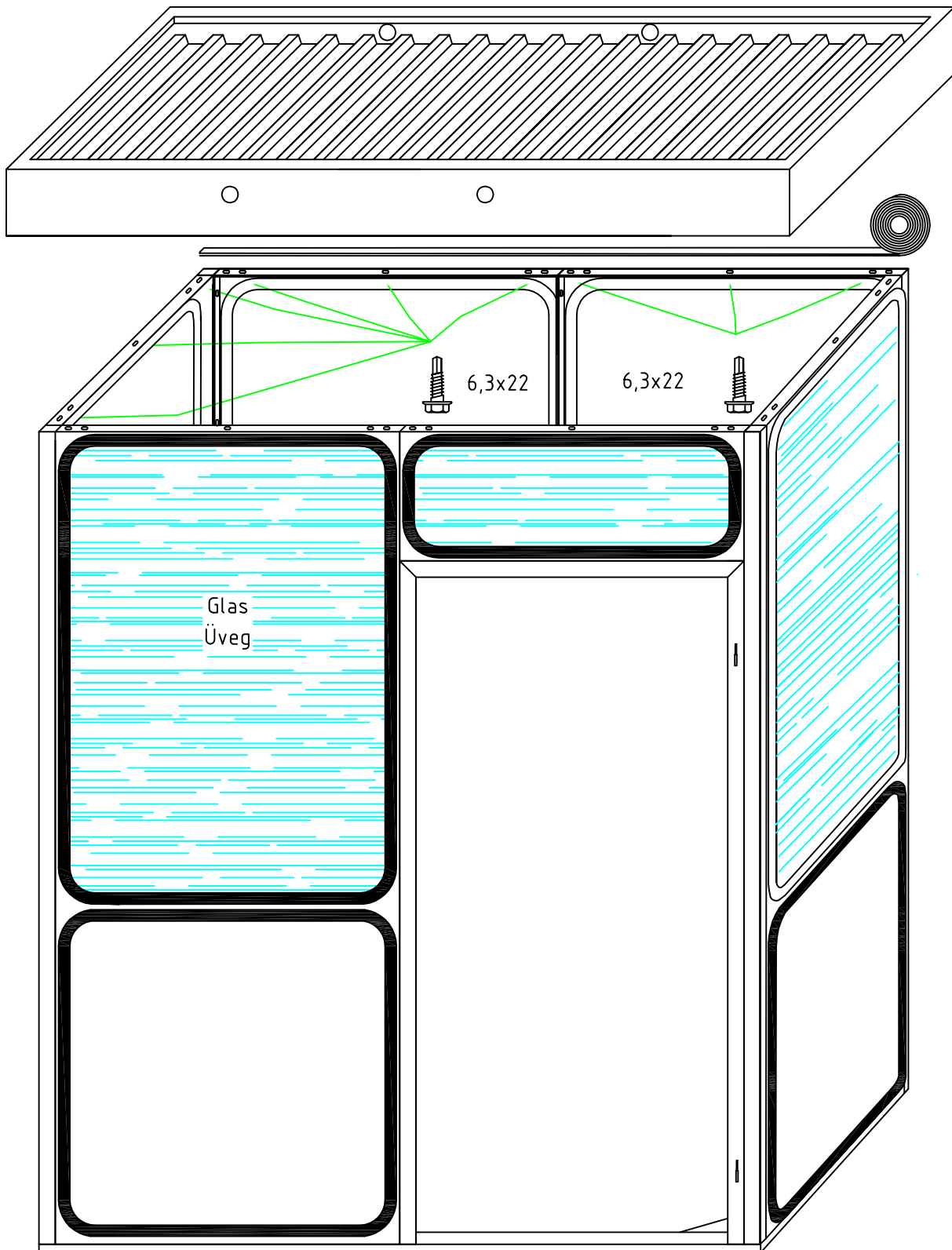

Abbildung 7
Fig. 7

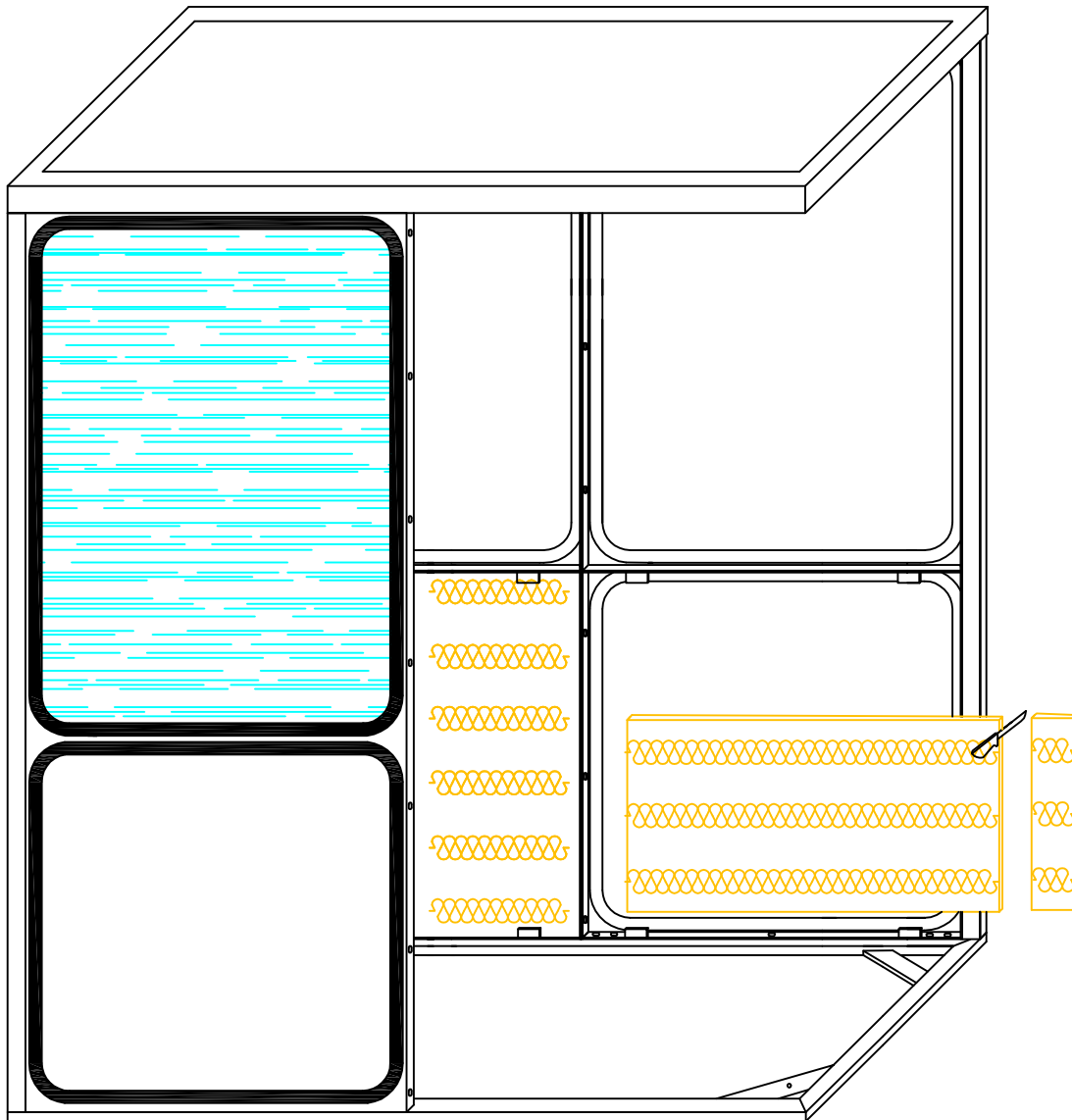

Abbildung 8.0
Fig. 8.0

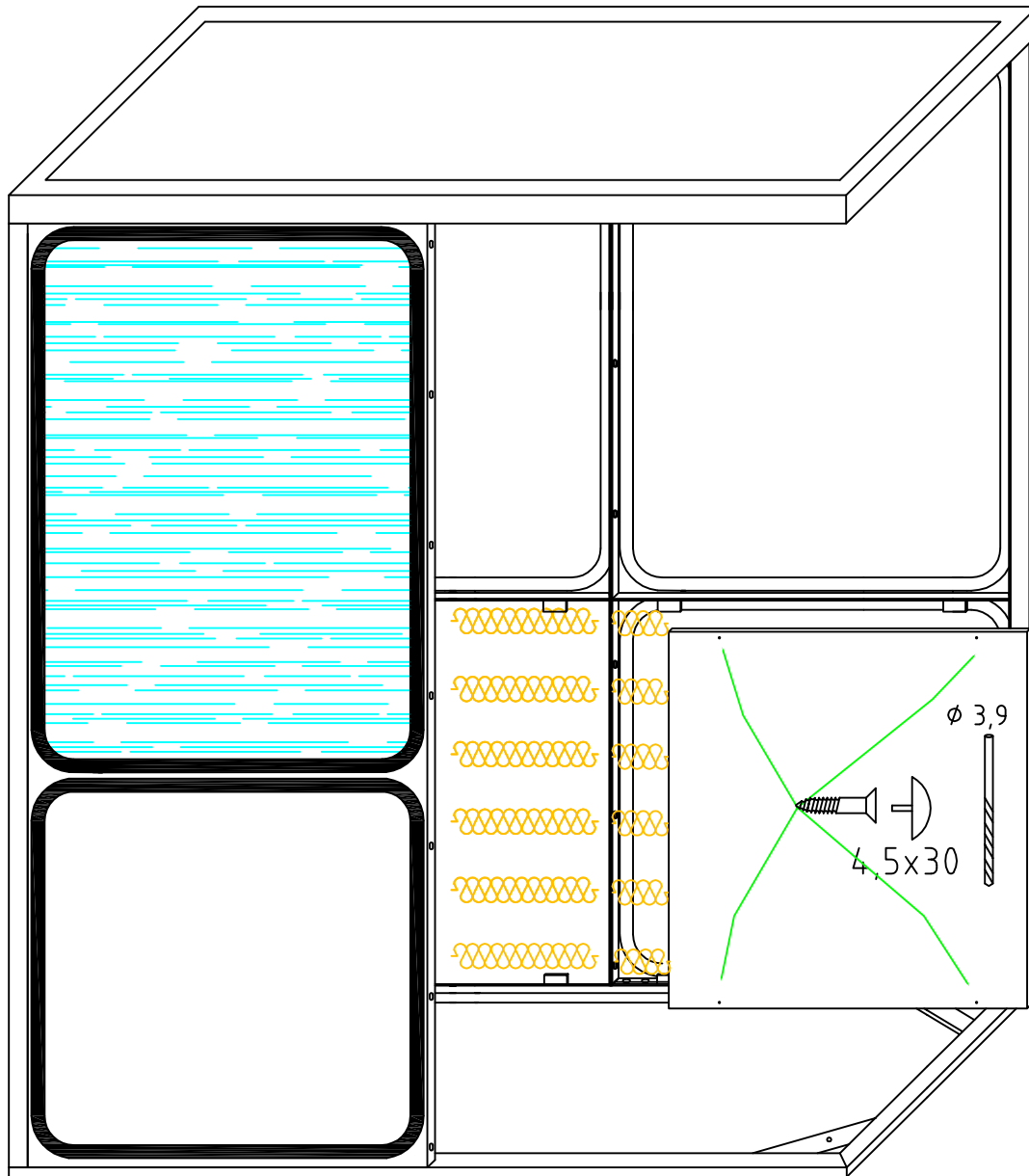
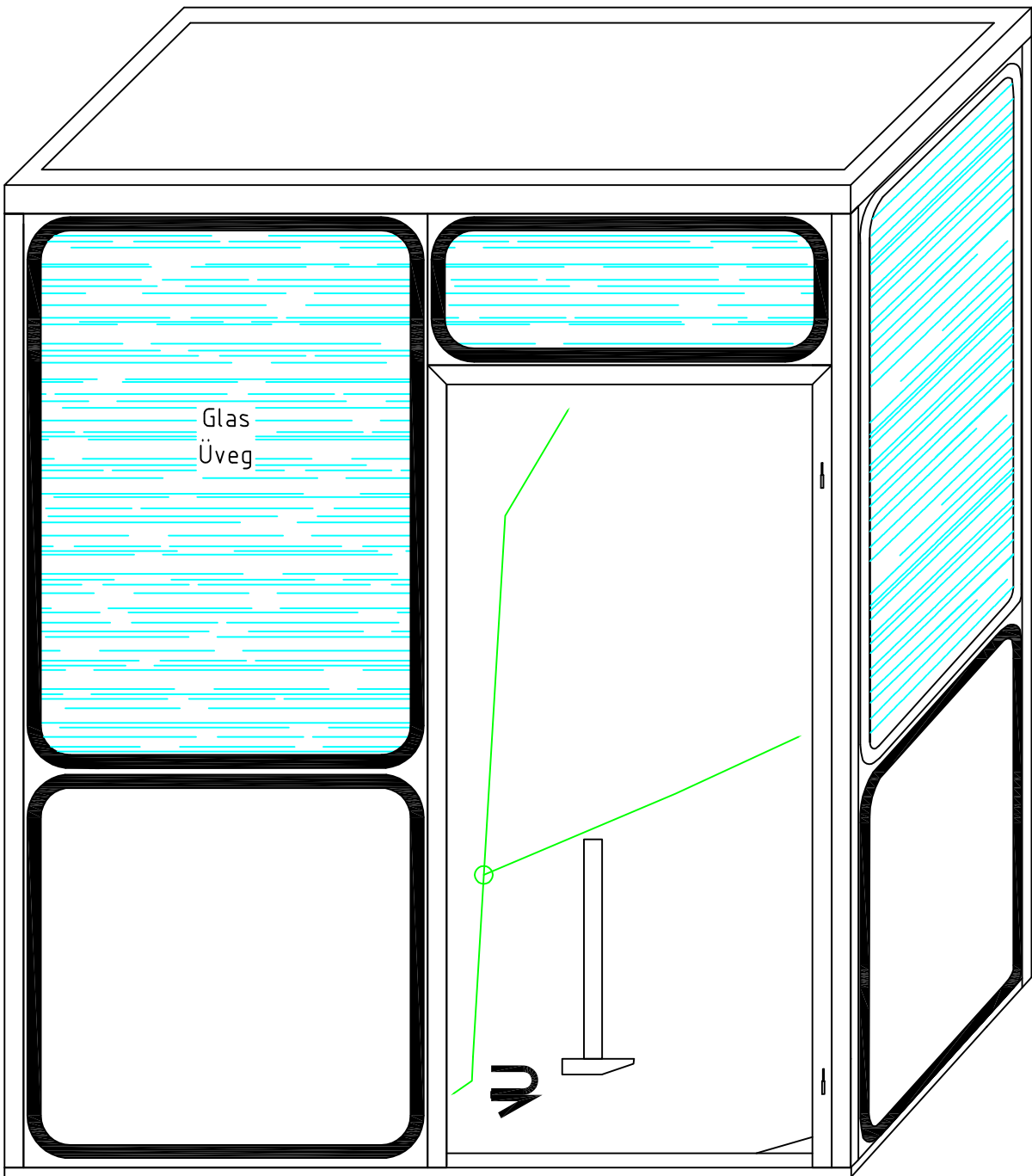
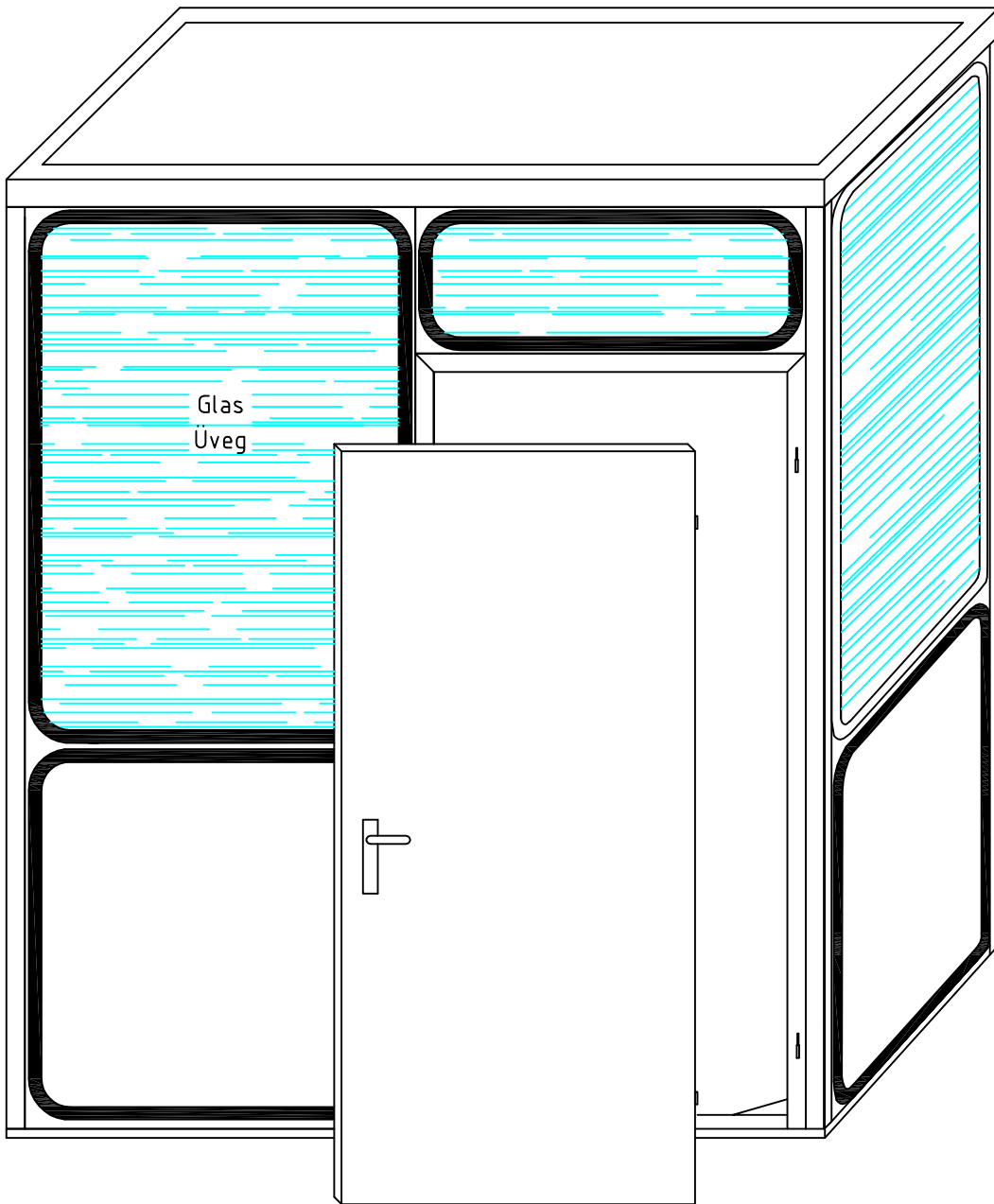

Abbildung 8.1
Fig. 8.1