

# Basic

9150E

9151E

9152E

9130

9133

9131

9140

9141



**bimos** – eine Marke der

Interstuhl Büromöbel GmbH & Co. KG

Brühlstraße 21

D 72469 Meßstetten-Tieringen

Telefon: 0 74 36-871-0

Telefax: 0 74 36-871-359

info@bimos.de

www.bimos.de

Ident. -Nr. 0003238

[www.bimos.de](http://www.bimos.de)

Montage- und Bedienungsanleitung  
Assembly and operating instructions

**bimos**



**A**

Seite 4-9



**E**

Seite 16-17



**B**

Seite 10-11



**F**

Seite 18



**C**

Seite 12-13



**G**

Seite 19

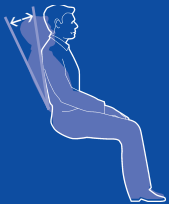

**D**

Seite 14-15

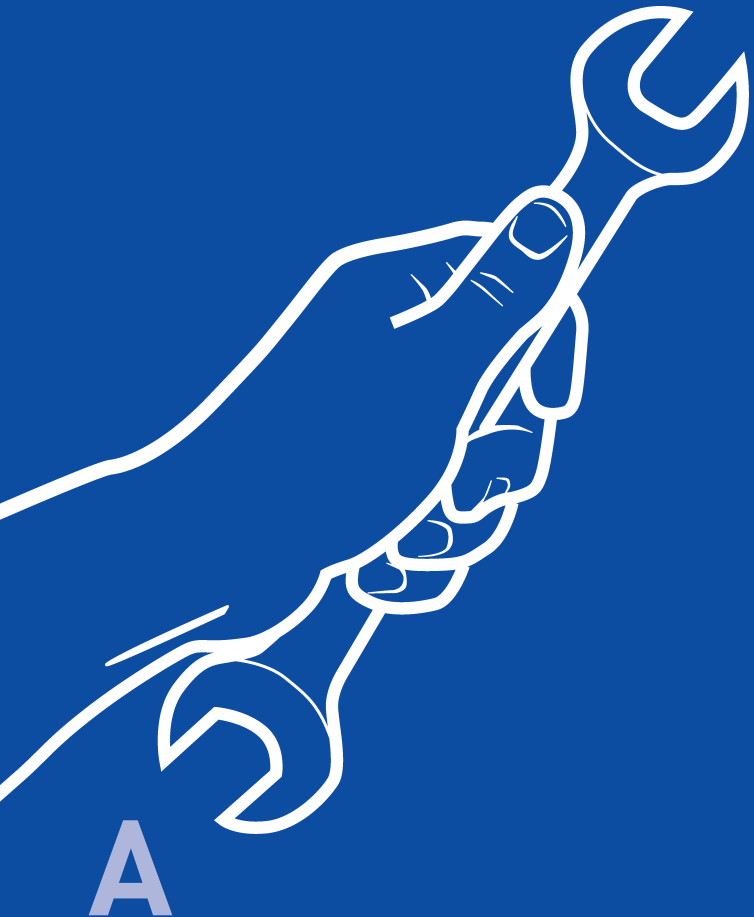

A

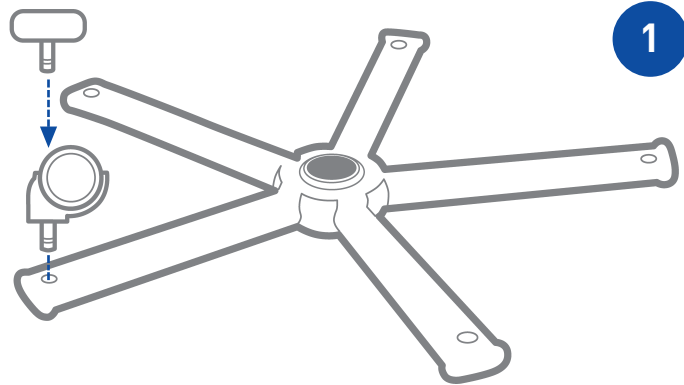

1

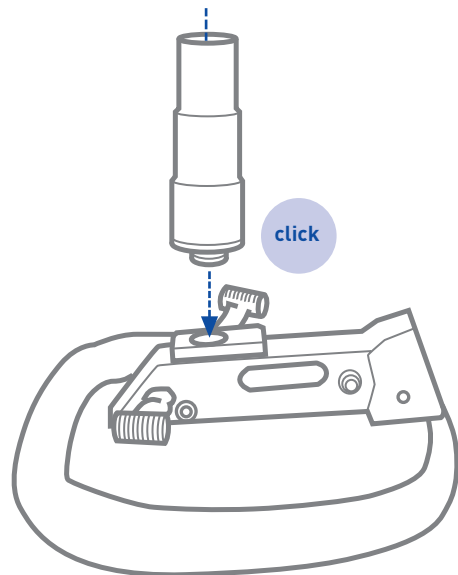

2

3

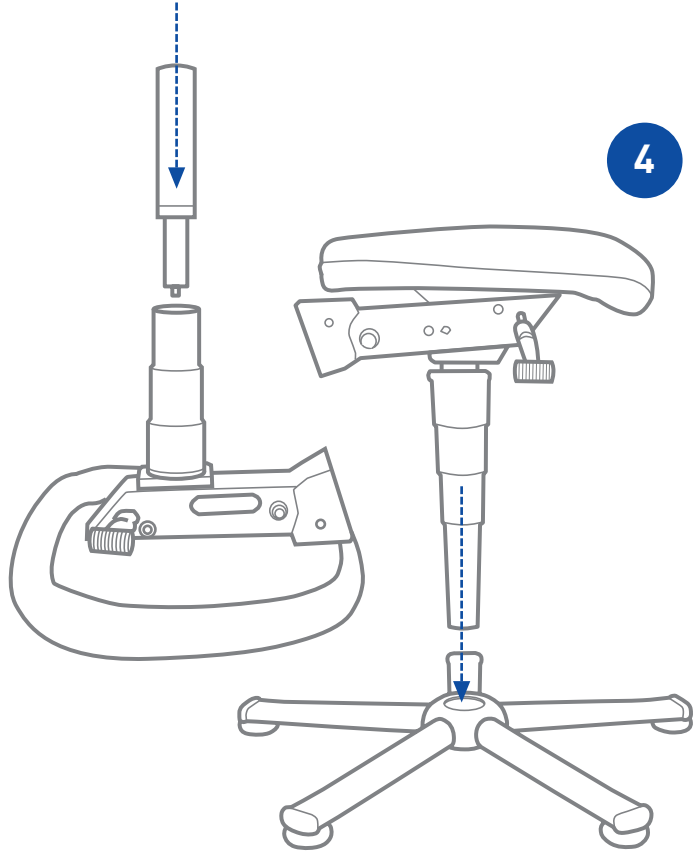

4

5

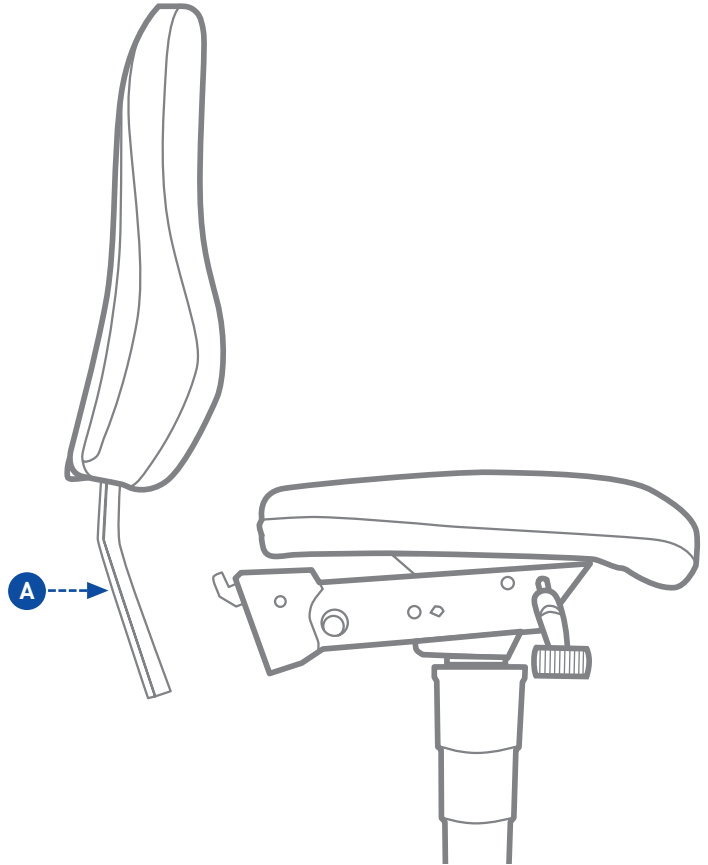

6

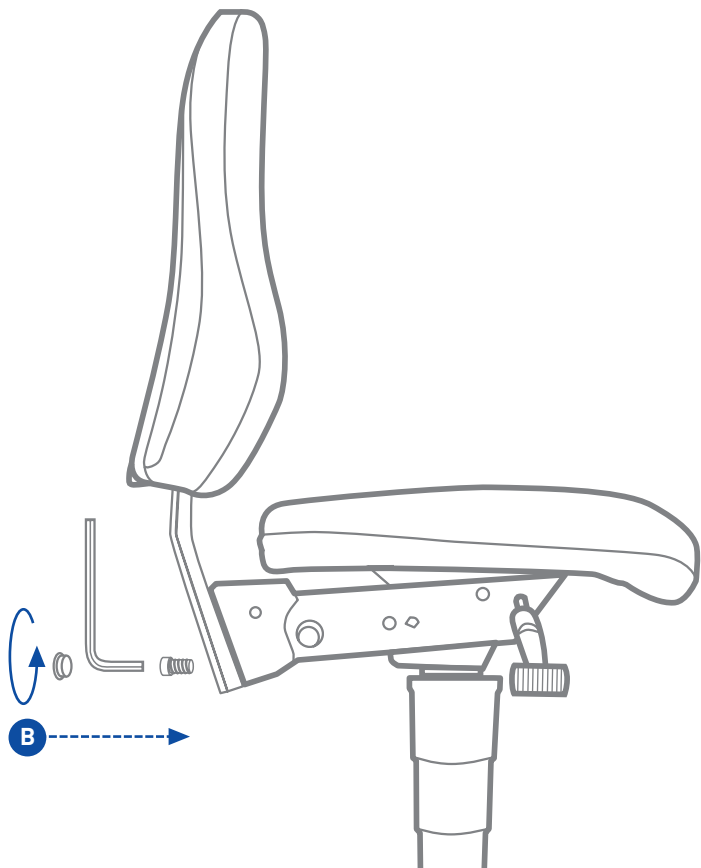

8

Typ 9152E  
Typ 9131  
Typ 9141

7

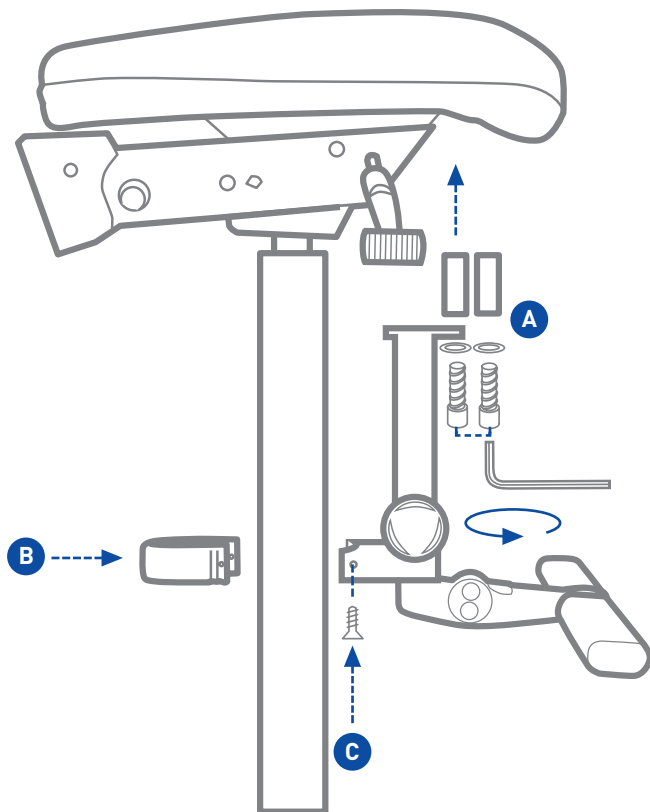

9

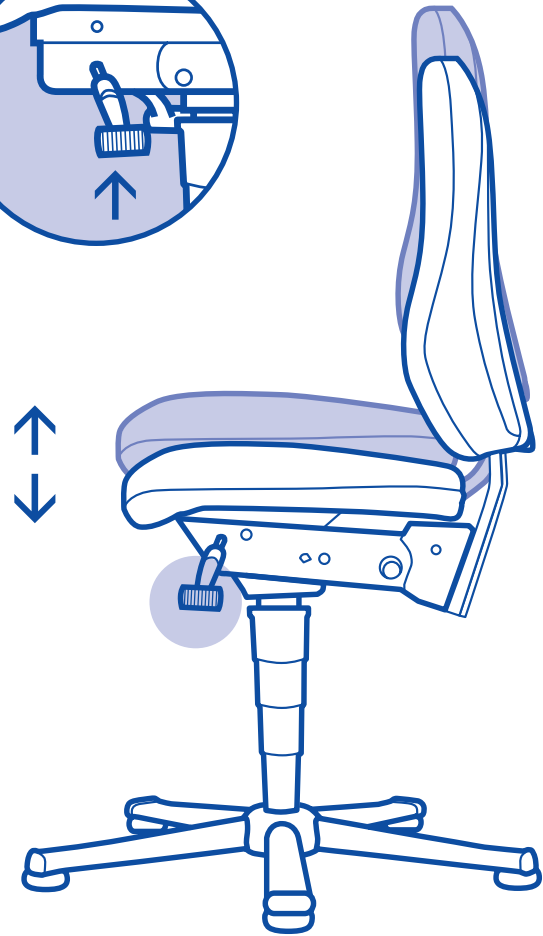
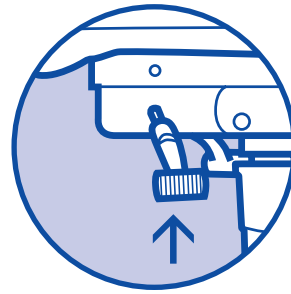
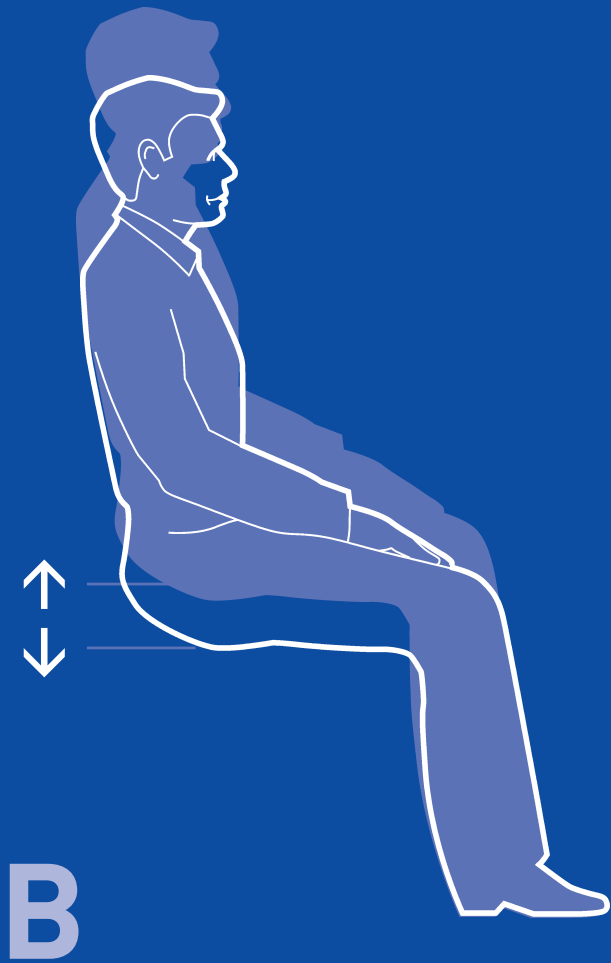

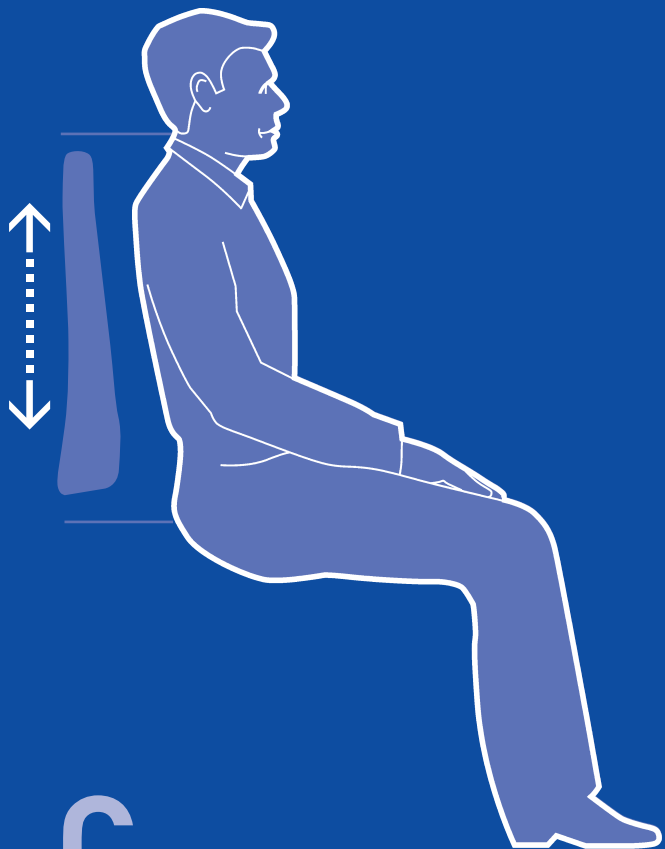

C

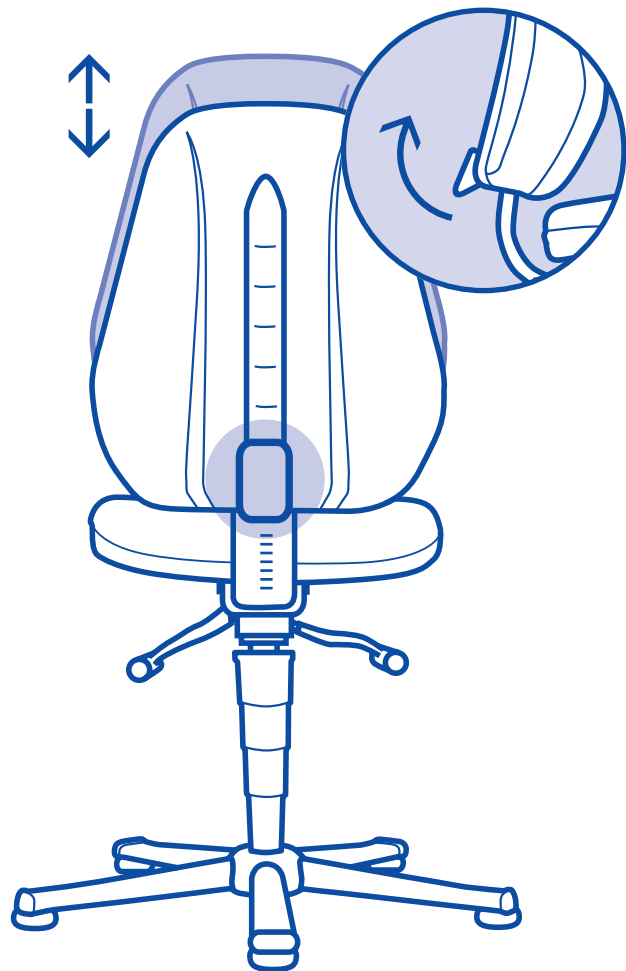

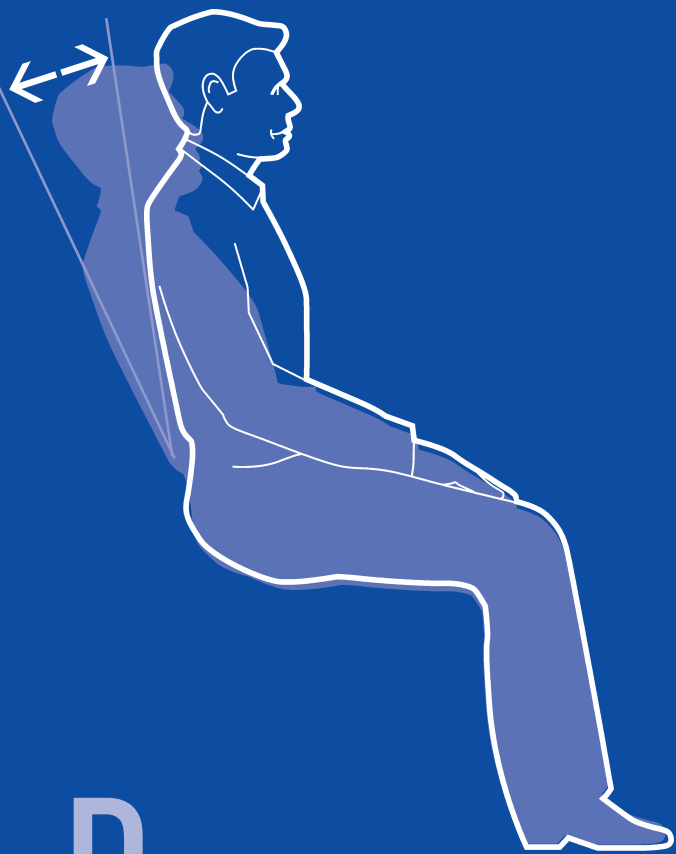

D

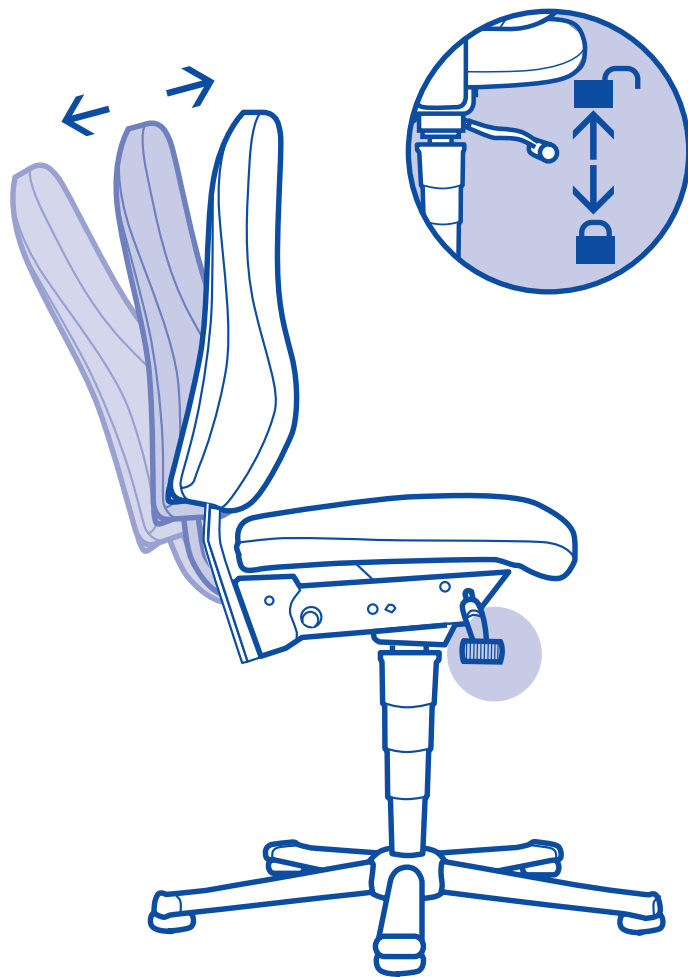



E

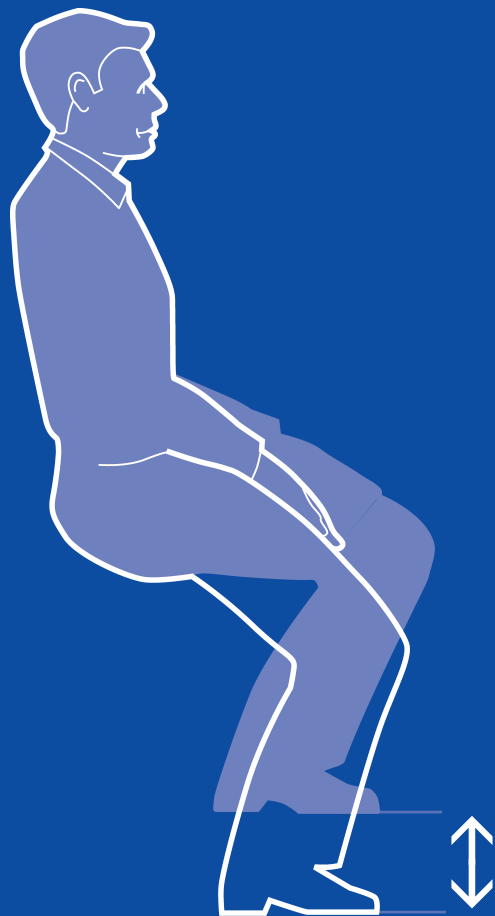

Typ 9152E  
Typ 9131  
Typ 9141

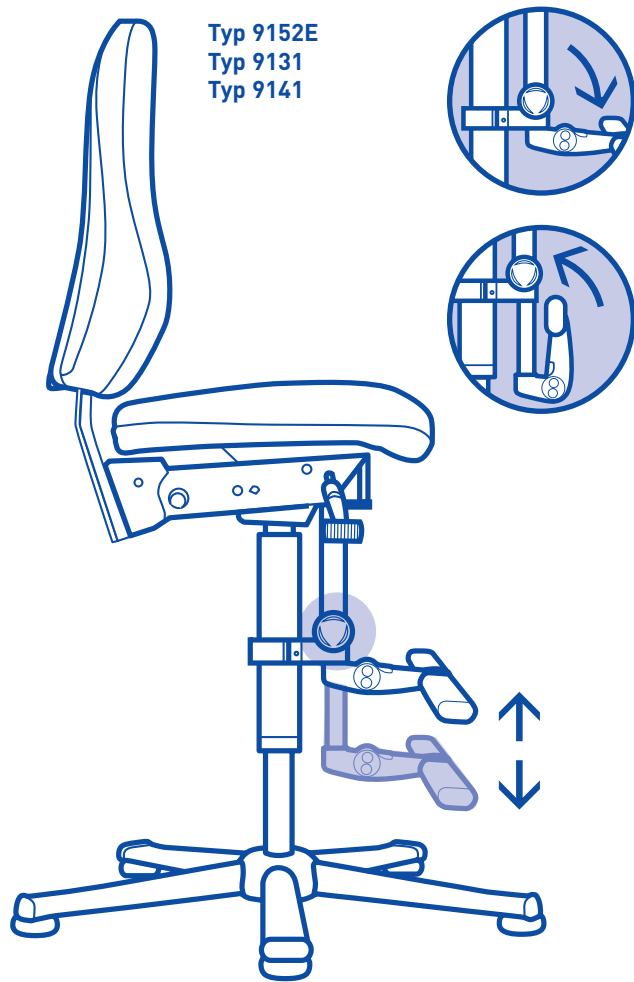

F



G



[www.bimos.de/cleaning.html](http://www.bimos.de/cleaning.html)

DIN  
68877



Garantie  
**5**  
Jahre

# Basic



9130-4523



9140-2571



9141-2571



9150E-9801



9151E-9801



9152E-2571



**bimos Produktion**



**bimos ESD**



**bimos Labor**



**bimos Reinraum**

# A passion for chairs



[www.interstuhl.de](http://www.interstuhl.de)



[www.bimos.de](http://www.bimos.de)

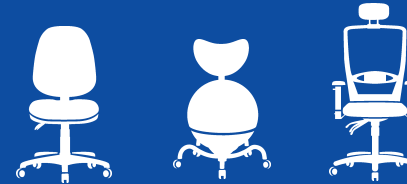

[www.prosedia.de](http://www.prosedia.de)