

European Community Design Registration RCD 000929971



Dispenser



Soap

Liquid

S1 System

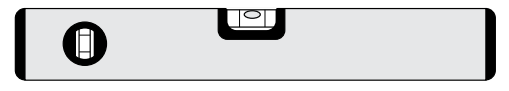
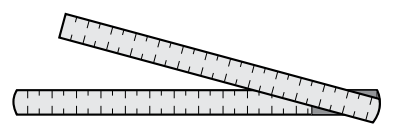
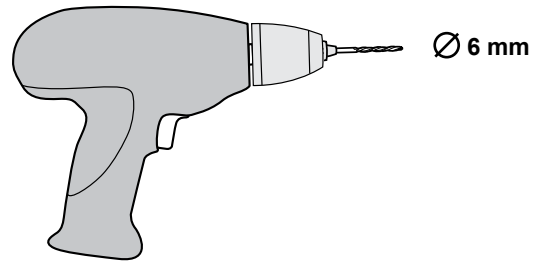
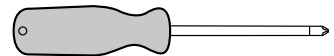
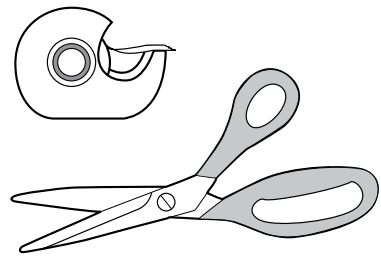
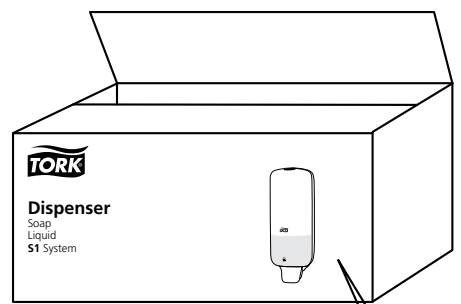

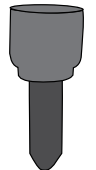

-  x 1
-  x 4
-  x 4
-  x 1

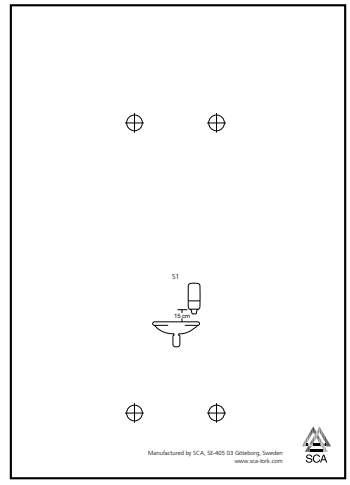
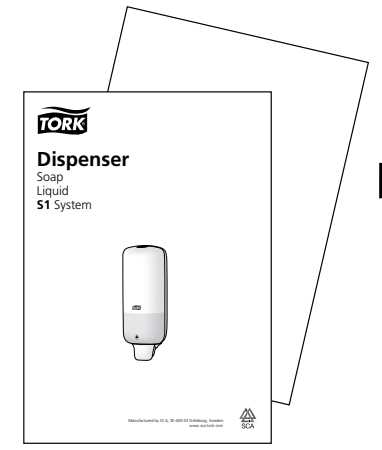
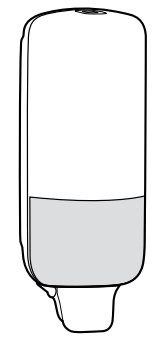



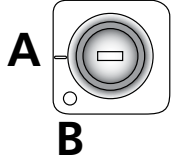

A

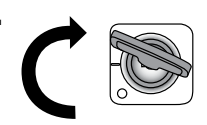
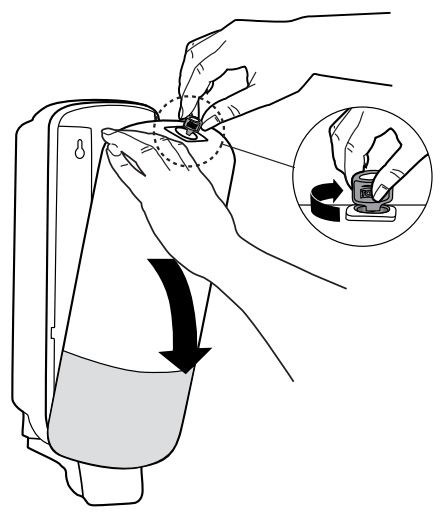

B

1. 
2. 
3. 

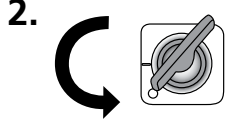
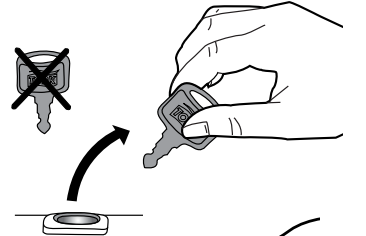
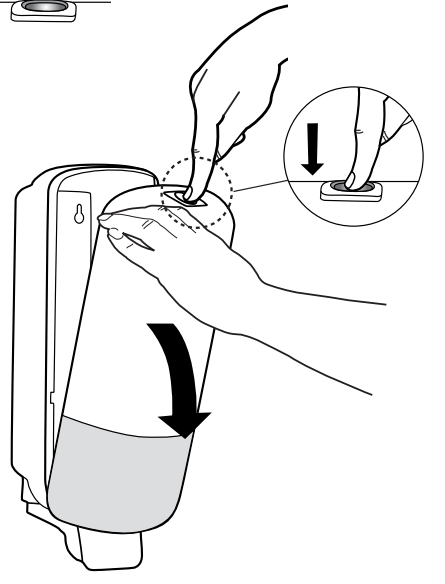
1. 
2. 
3. 
4. 

3.

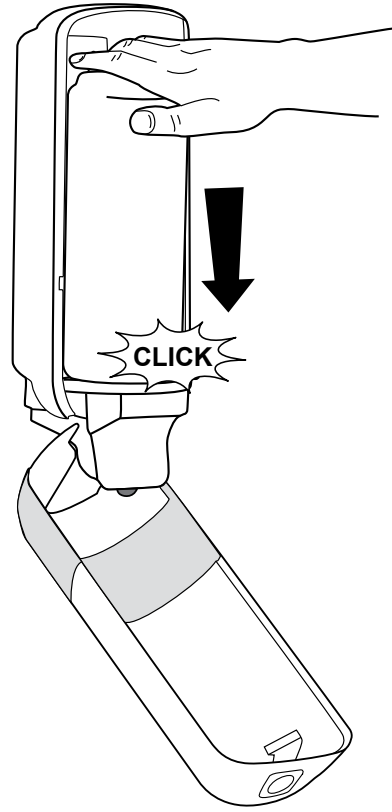

4.

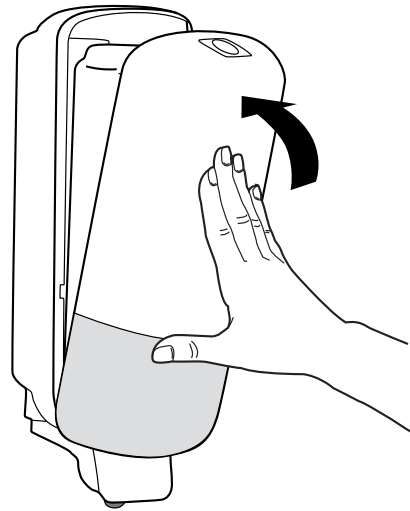

5.

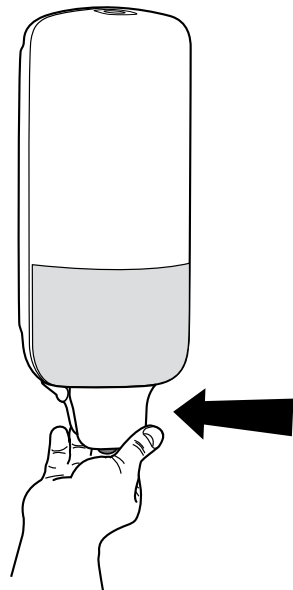

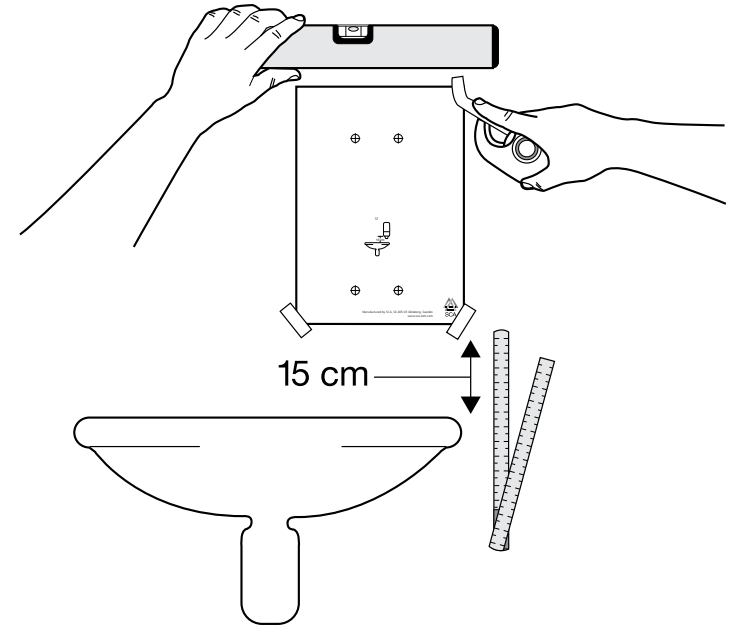

1.

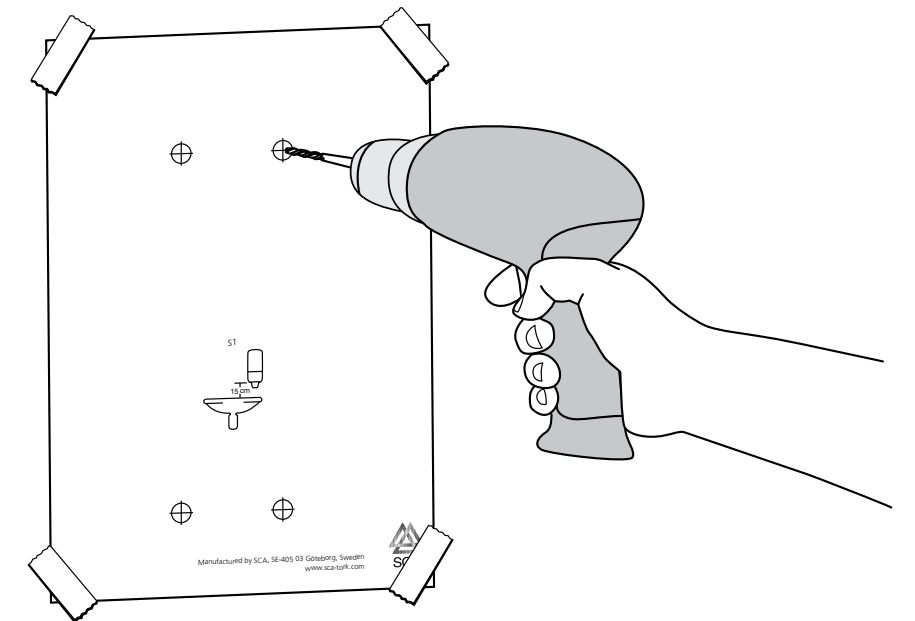

2.

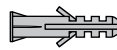

3.

-  x 4
-  x 4

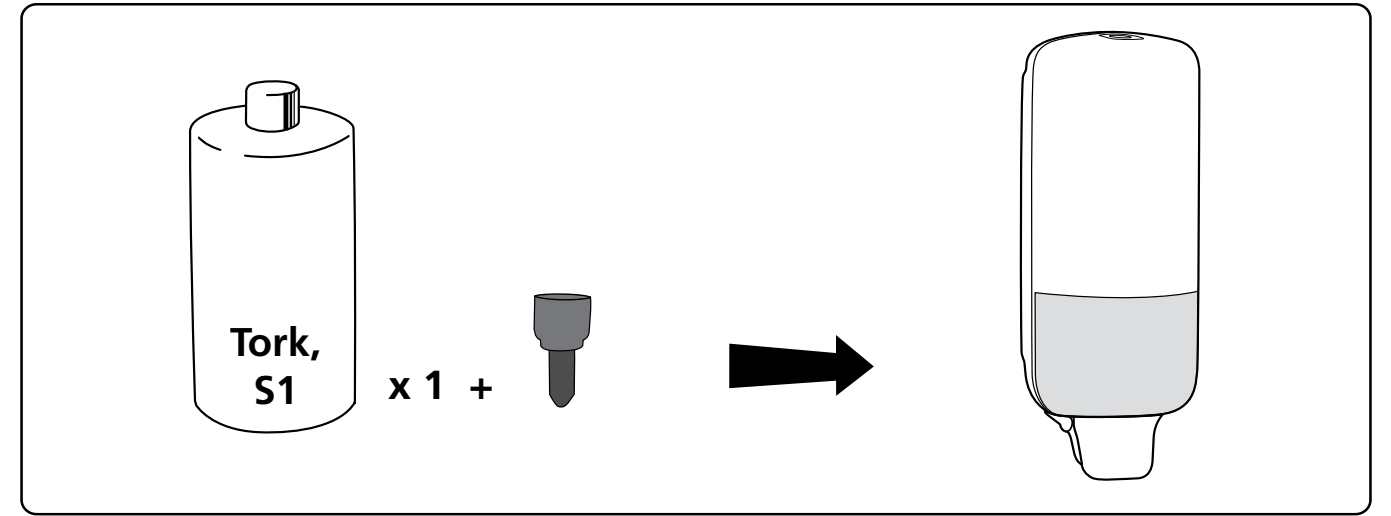
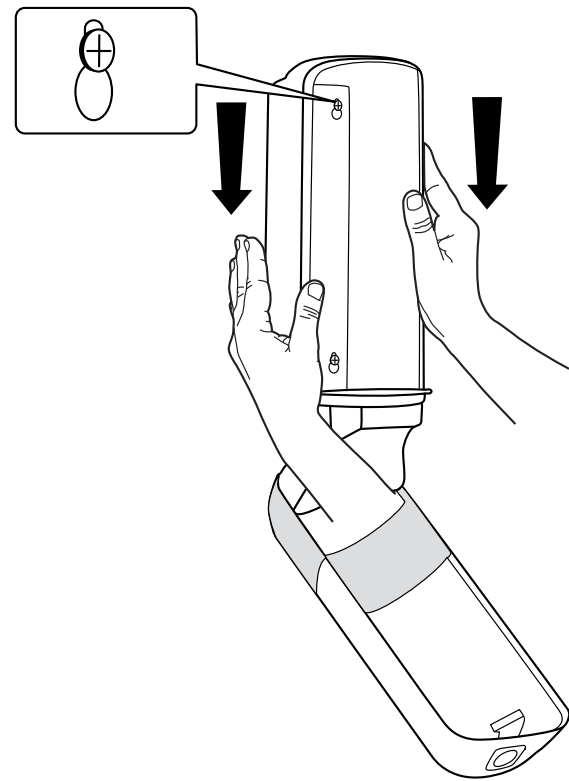
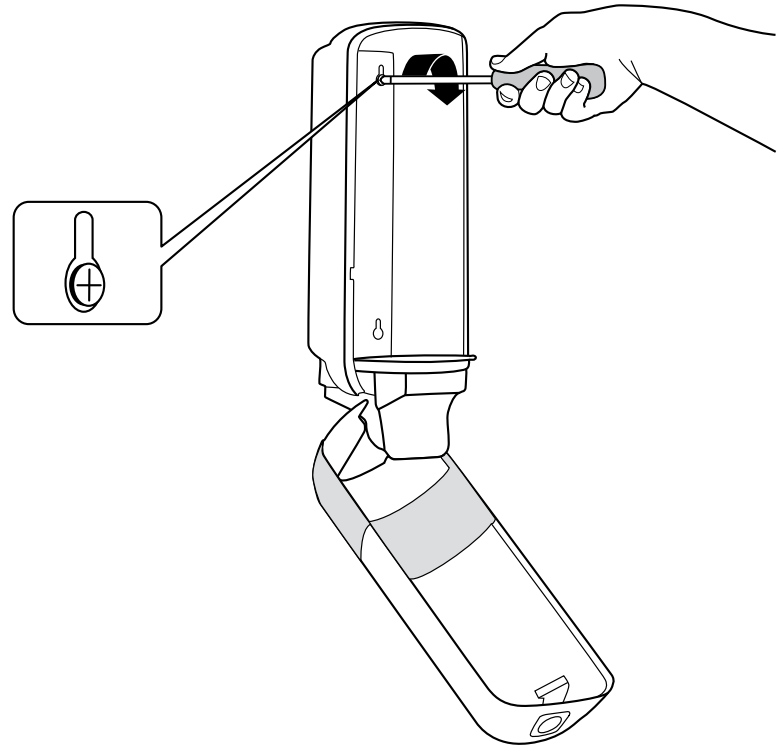

1.

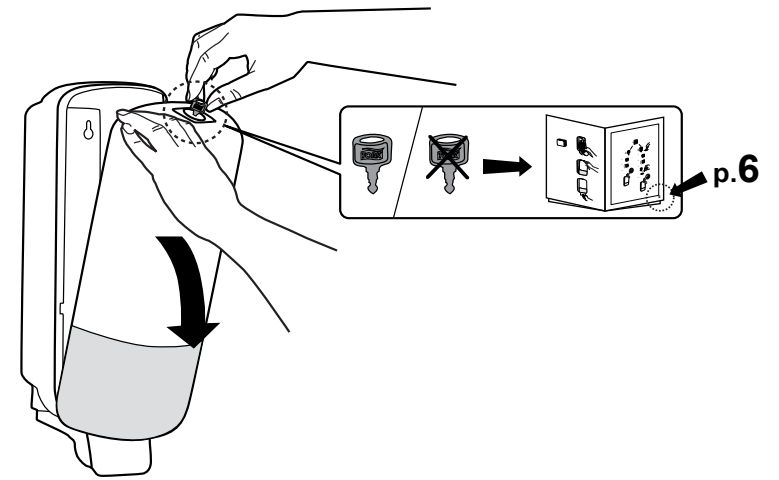

2.

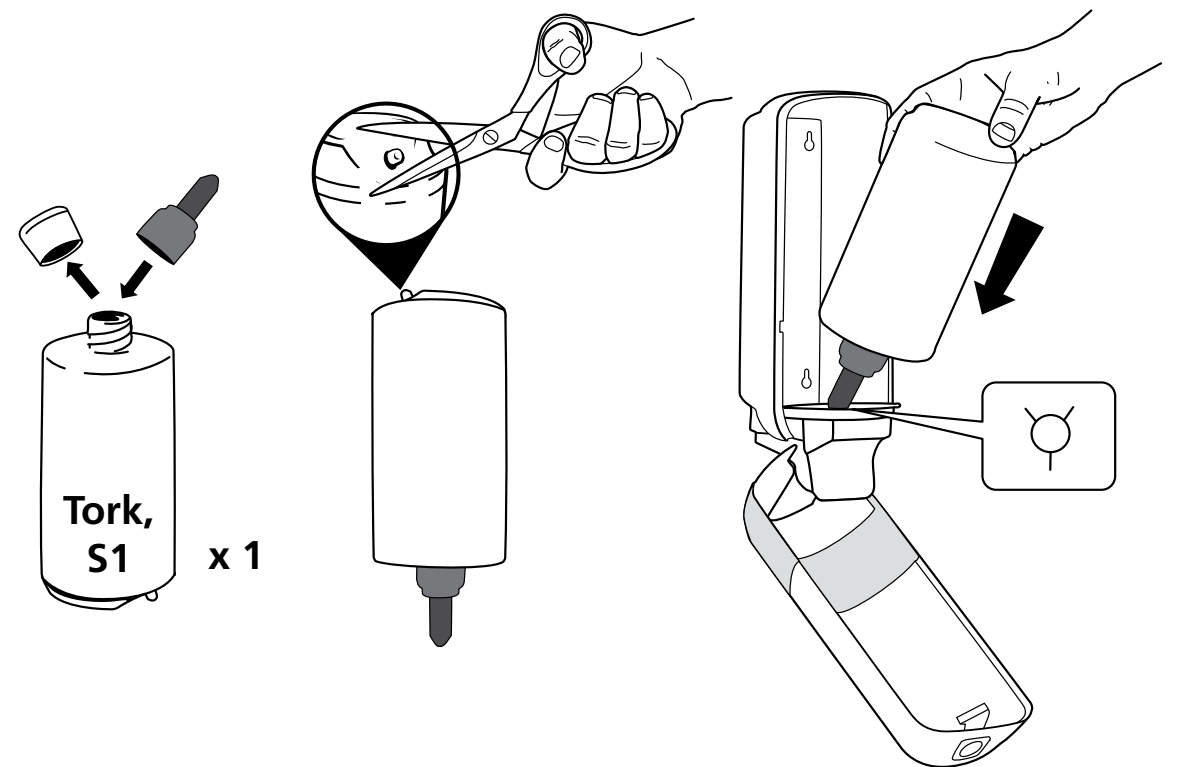



S1

