

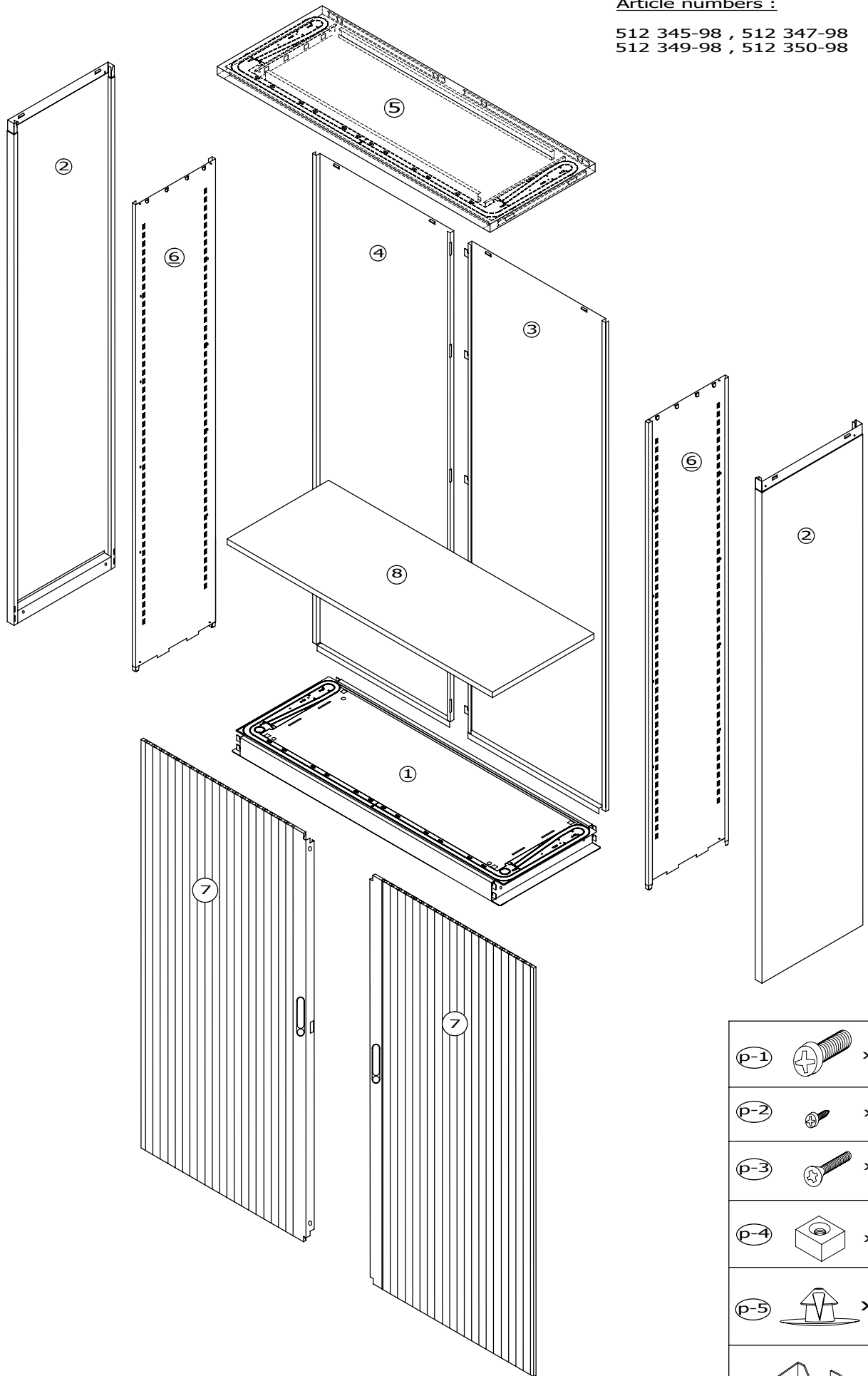





Article numbers :

512 345-98 , 512 347-98
512 349-98 , 512 350-98



p-1		x 4
p-2		x 4
p-3		x 2
p-4		x 2
p-5		x 2
p-6		x 16
SHELF CAPACITY 45 kg		

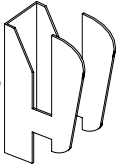