

Montageanleitung :
 Korpus - Regalserie M6.../M7.../M8...
 Assembly instruction : corpus - shelves M6.../M7.../M8...

5

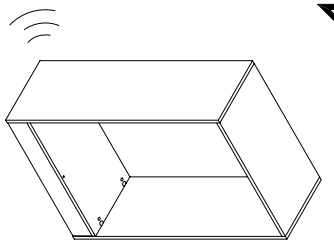

4 x G

7

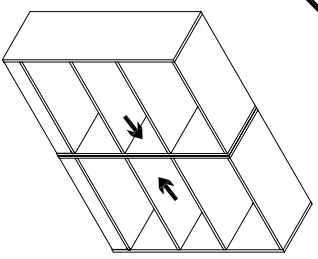

6

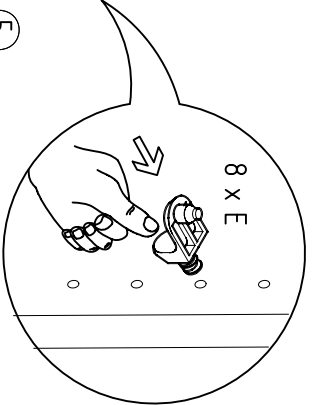
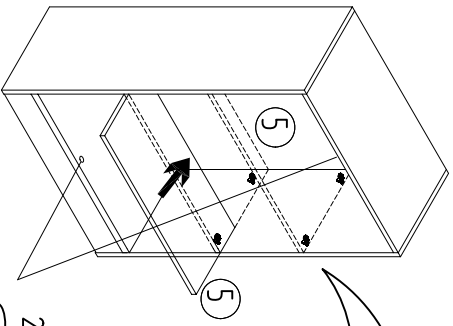

2 x H

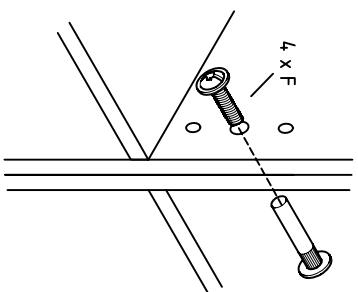
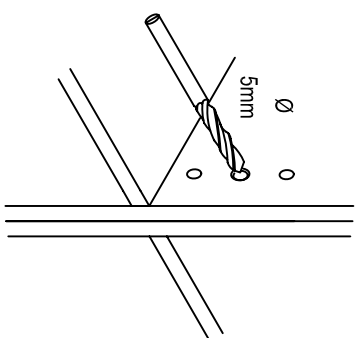



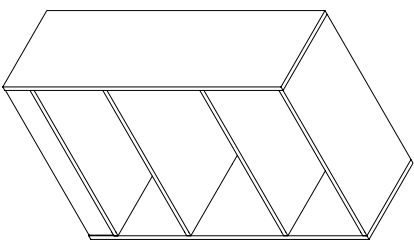



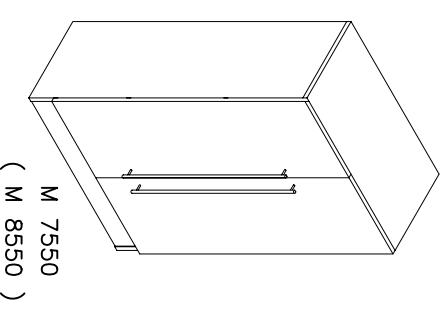
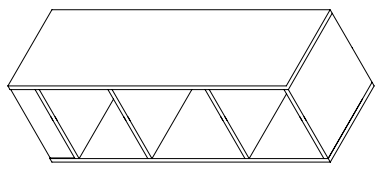

M 6500



M 6050



Inhalt: Beschlagbeutel :
Fittings :

4 x A 	12 x B  (4 x 16 mm)	8 x C 	6 x D  (3,5 x 25 mm)
8 x E 	4 x F 	4 x G 	2 x H 

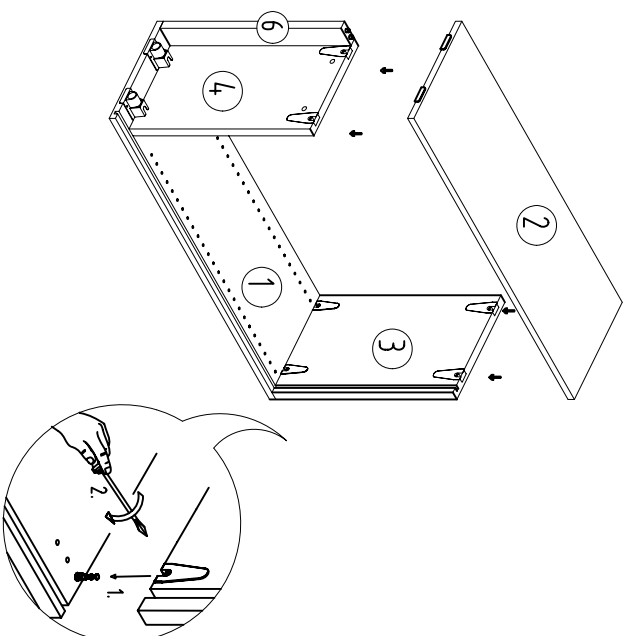
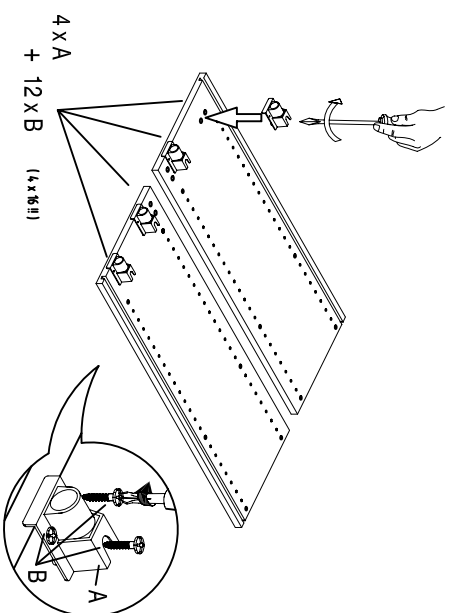
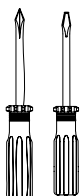
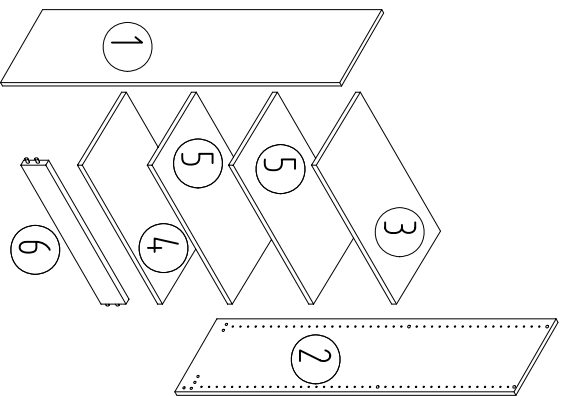
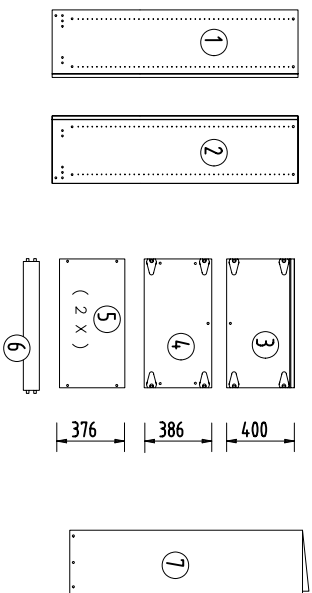

8 x C

