



 A=1508mm	 A=1820mm	 A=1974mm	 A=2522mm
ΣQmax	1800 kg	2250 kg	2700 kg	3150 kg
A	4x	4x	4x	4x
B	8x	10x	12x	14x
C	8x	10x	12x	14x
D	4x	5x	6x	7x
E	4x	4x	4x	4x
F,G	8x	8x	8x	8x
H	2x	2x	2x	2x
J	4x	5x	6x	7x



Trestles, a.s.  
Na Skotnici 1168  
735 71 Detmarovice  
CZ

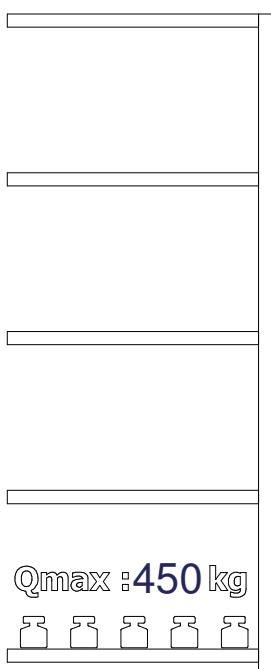
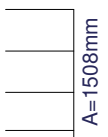
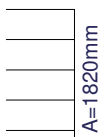

	 A=1508mm	 A=1820mm	 A=1976mm	 A=2522mm
ΣQmax	1800 kg	2250 kg	2700 kg	3150 kg
A	2x	2x	2x	2x
B	8x	10x	12x	14x
C	8x	10x	12x	14x
D	4x	5x	6x	7x
E	2x	2x	2x	2x
F,G	4x	4x	4x	4x
H	1x	1x	1x	1x
J	4x	5x	6x	7x



1

cca  
0 mm

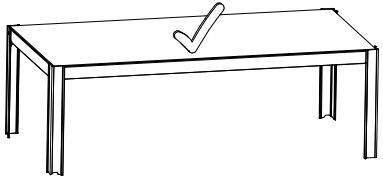

B  
MIN. 3x  
MAX. 9x

B  
MIN. 3x  
MAX. 9x

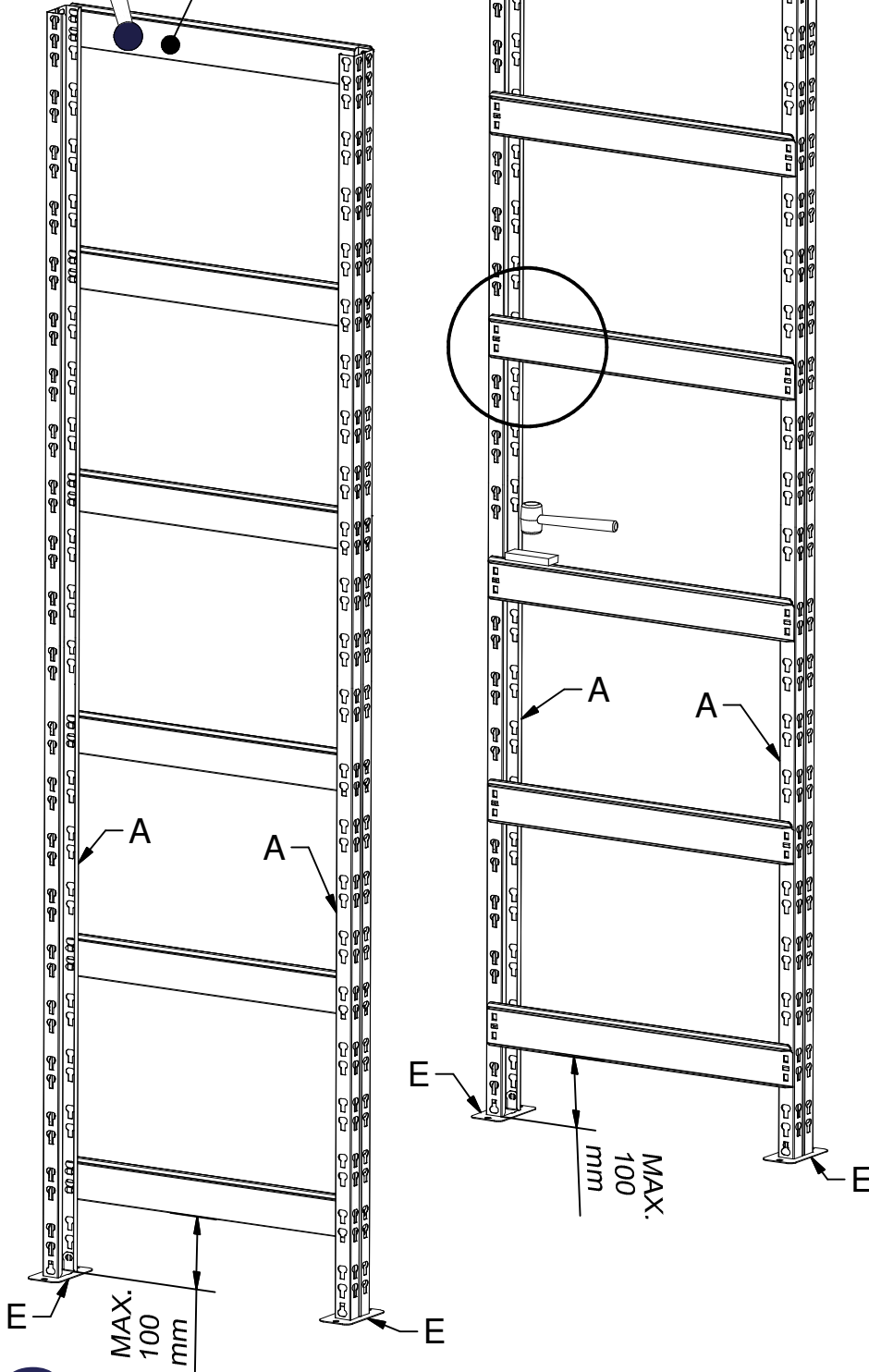
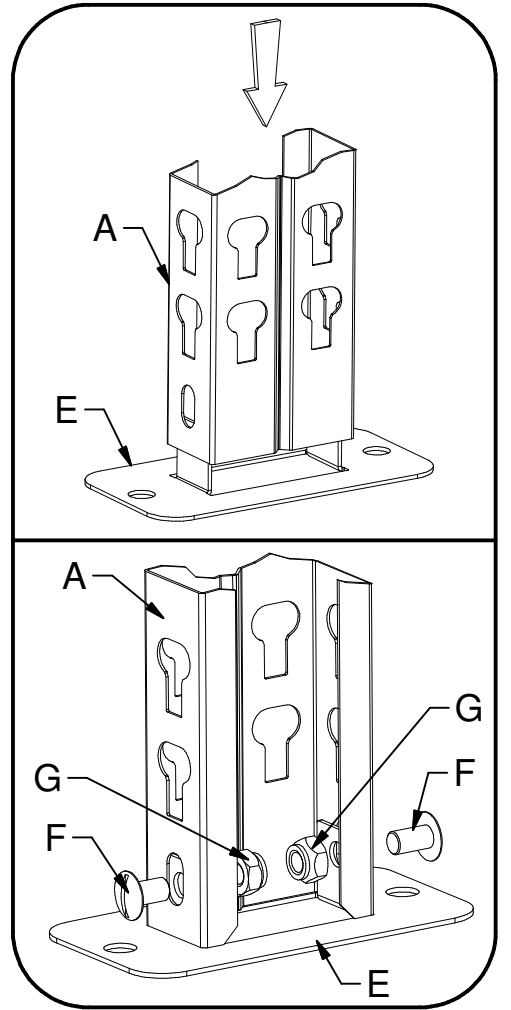
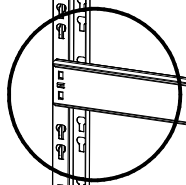
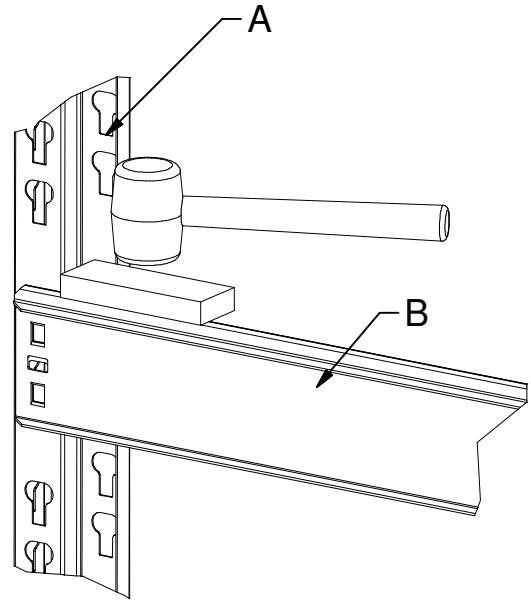

MAX.  
100  
mm

MAX.  
100  
mm

2.



