



Camshelving® assembly instructions

page 3

Instructions d'assemblage du système Camshelving®

page 7

Montageanleitung für Camshelving®

Seite 11

Istruzione per l'assemblaggio del Camshelving®

pagina 15



CAMBRO®

CAMSHELVING® ASSEMBLY INSTRUCTIONS



SINGLE UNIT ASSEMBLED



SINGLE UNIT AND ADD-ON UNIT ASSEMBLED.
MIDDLE POST IS SHARED BY BOTH UNITS



SINGLE UNIT AND ADD-ON UNIT ASSEMBLED
WITH CORNER CONNECTORS.

**PLEASE READ DIRECTIONS BEFORE BEGINNING ASSEMBLY.
PROPER ASSEMBLY REQUIRES USING A RUBBER Mallet – DO NOT USE A METAL HAMMER!**

ASSEMBLY SUGGESTIONS

- The unique engineering of the post connectors provides exceptional cross stabilization. This stability can be augmented by locating the bottom shelf as close to the bottom of the post as possible.
- For safety considerations, place heavier loads on bottom shelves and lighter loads on upper shelves.
- Camshelving is designed to hold 200 kg. per shelf using a 60 cm to 120 cm traverse and 150 kg. per shelf using a 130 cm to 170 cm traverse on a standard 4 post unit.
- The casters for Camshelving for mobile units can support 340 kg per unit.
- Shelves attached with a Corner Connector have a maximum weight bearing of 180 kg. and should be used on 120 cm traverses or less.
- Use a rubber mallet for assembly. When tapping post connectors and traverses onto posts, be sure the post connectors are fully engaged on to posts. **DO NOT OVER TAP.**
- When building corner units, the Corner Connector should support the shorter traverse length. Place heavier loads on main unit, lighter loads on unit connected with Corner Connectors.

CLEANING INSTRUCTIONS

The surface of Camshelving is made of polypropylene. Polypropylene is stain and chemical resistant and can be cleaned with most common cleansers.

The Camshelving shelf plates can be removed, placed in a Camrack OETR314, which is an open ended dishrack, and washed in a commercial dishwasher. Traverses can also be removed and placed directly on a dishwasher conveyor and washed in the dishwasher.

The posts and post connectors can be steam cleaned or cleaned by hand using a cleanser applied to a cloth or sponge. To do so, prepare cleaning solutions according to detergent manufacturer directions. Wash surface with a cloth or sponge, rinse thoroughly and wipe dry. If a commercial dishwasher is not available, Camshelving shelf plates and traverses can be washed in this manner as well.

A. ASSEMBLY PREPARATIONS

1 Layout all parts, identify and count.

a. Post Kits: Include 2 Posts, 1 Top Post Connector and 1 Bottom Post Connector.

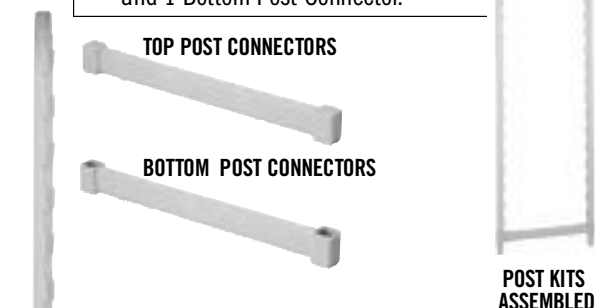

b. Shelf Kits: Include 2 Traverses and Shelf Plates to cover the length of the Traverses

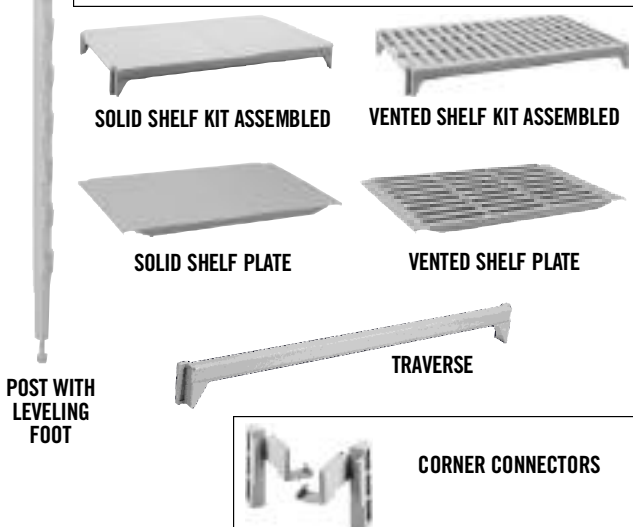

CAMSHELVING® ASSEMBLY INSTRUCTIONS

PLEASE READ DIRECTIONS BEFORE BEGINNING ASSEMBLY.
PROPER ASSEMBLY REQUIRES USING A RUBBER Mallet – DO NOT USE A METAL HAMMER!

B. TO ASSEMBLE SINGLE UNIT

1 Assemble Post Kits

- Hold two Posts with dovetails facing each other.
- Mount bottom Post Connector on the two Posts using a rubber mallet, following directions on arrow. Tap each side alternating until connector is firmly in place.
- Mount top Post Connector on top of the two Posts. Alternate tapping each side until connector is firmly in place.
- Repeat for second post frame.

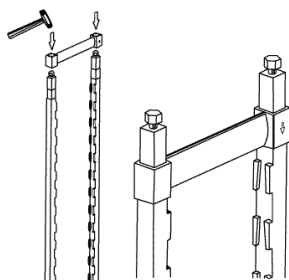

MOUNT BOTTOM POST CONNECTOR

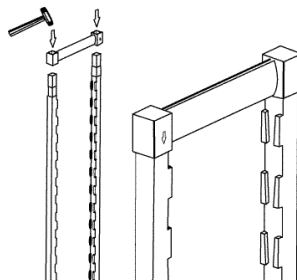

MOUNT TOP POST CONNECTOR



POST AND POST CONNECTORS ASSEMBLED

2 Mount traverses

- Select shelf placement.
- Mount traverses on posts:
 - Align the bottom of the traverse dovetail opening with the bottom of the dovetail on the posts.
 - Press the traverse against the posts.
 - Lower the traverse down.
 - Secure into position by tapping both ends of the traverse with a rubber mallet.
- Mount traverse on opposite side of post frame. Repeat for all shelves on the unit.

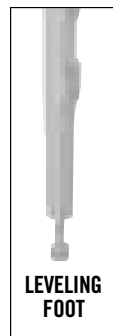

LEVELING FOOT

3 Determine if unit is level. If necessary, adjust leveling foot using a 24 wrench.

4 Place shelf plates on traverses.

Refer to Shelf Plate Set Configurations on back page of these assembly instructions.

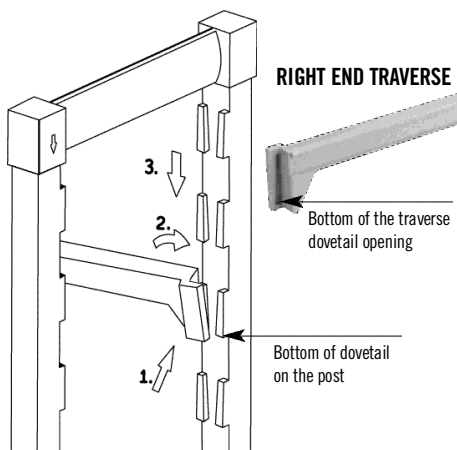

MOUNT TRAVERSES ON POSTS

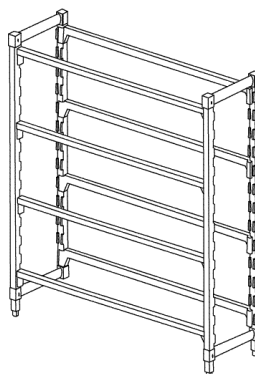

ALL TRAVERSES MOUNTED



PLACE SHELF PLATES ON TRAVERSES

CAMSHELVING® ASSEMBLY INSTRUCTIONS

PLEASE READ DIRECTIONS BEFORE BEGINNING ASSEMBLY.
 PROPER ASSEMBLY REQUIRES USING A RUBBER Mallet – DO NOT USE A METAL HAMMER!

C. TO ADD-ON A UNIT IN A STRAIGHT LINE

- 1 Assemble first unit as described in step (B).
- 2 Assemble another Post Kit as described in step (B1).
- 3 Mount traverse between Post on first unit and additional Post Kit.
The traverses on the first and second unit share the middle Post.
- 4 **Determine if unit is level.** If necessary, adjust leveling foot using a 24 wrench.
- 5 Place shelf plates on traverses.

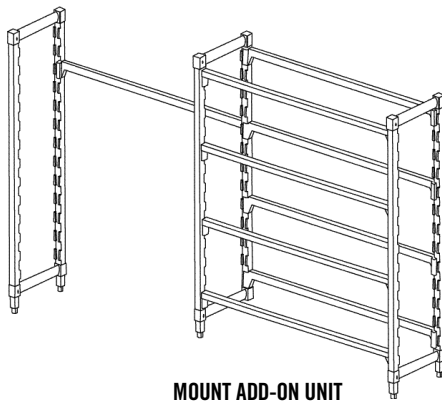

MOUNT ADD-ON UNIT



SINGLE UNIT AND ADD-ON UNIT ASSEMBLED.
 MIDDLE POST IS SHARED BY BOTH UNITS

D. TO ADD-ON A UNIT IN A 90° CORNER

- 1 Assemble first unit as described in step (B).
- 2 Assemble another post frame as described in step (B1).
- 3 Identify right and left Corner Connectors and mount on traverses of first unit.
To mount Corner Connectors:
 - a. Insert top edge of Corner Connector into groove on top edge of traverse.
 - b. Snap Corner Connector around bottom edge of traverse.
 - c. Move Corner Connector to appropriate location on Traverse to match width of second unit.
- 4 Repeat mounting a right and left Corner Connector on each shelf of first unit.
- 5 Mount Traverses between Corner Connectors and additional Post Frame.
 - a. The Traverses click on to the Dovetail on the Corner Connectors just like they click onto the Dovetails on the Posts.
- 6 **Determine if unit is level.** If necessary, adjust leveling foot using a 24 wrench.
- 7 Place shelf plates on traverses.



CORNER CONNECTORS

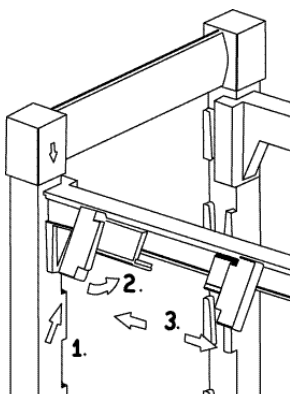

SNAP CORNER CONNECTOR
 ON TRAVERSE

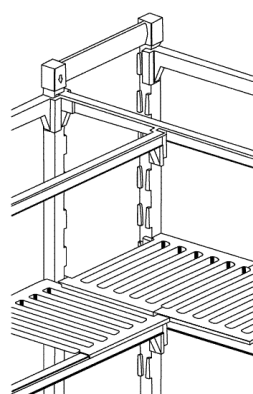

MOUNT TRAVERSES



CAMBRO Corner Connectors Helpful Hints

- Maximum weight capacity for shelves connected with Corner Connectors is 180 kg.
- Traverses connected with Camshelving® Corner Connectors should be 120 cm or shorter.
- If connecting traverses of different lengths, mount the Corner Connectors onto the longer traverses and mount the shorter Traverses onto the Corner Connectors.

CAMSHELVING® SHELF PLATE SET CONFIGURATIONS

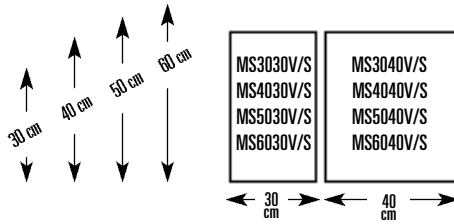

S or V designates Solid or Vented Shelf Plate.

Shelf Configuration for 60 cm Traverse.

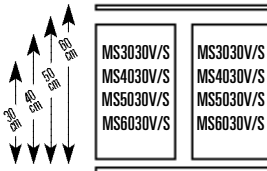

Shelf Configuration for 70 cm Traverse.

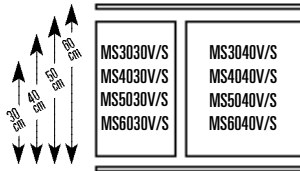

Shelf Configuration for 80 cm Traverse.

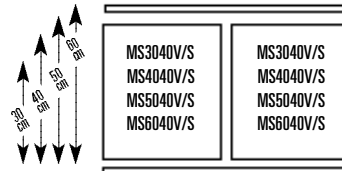

Shelf Configuration for 90 cm Traverse.

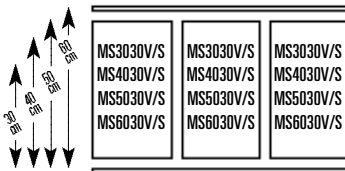

Shelf Configuration for 100 cm Traverse.

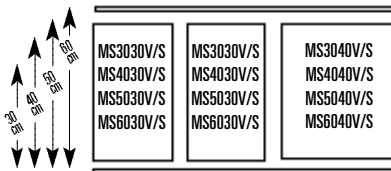

Shelf Configuration for 110 cm Traverse.

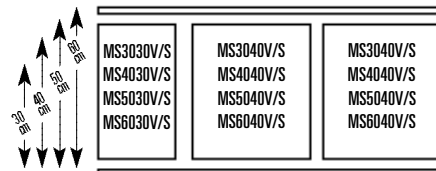

Shelf Configuration for 120 cm Traverse.

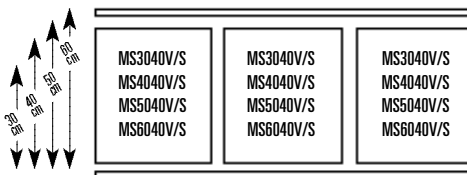

Shelf Configuration for 130 cm Traverse.

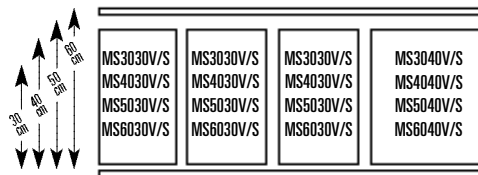

Shelf Configuration for 140 cm Traverse.

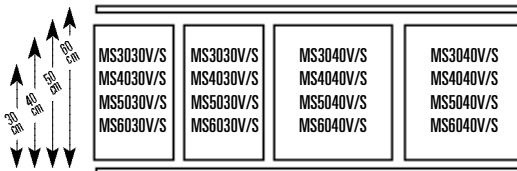

Shelf Configuration for 150 cm Traverse.

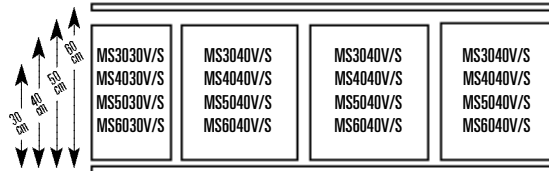

Shelf Configuration for 160 cm Traverse.

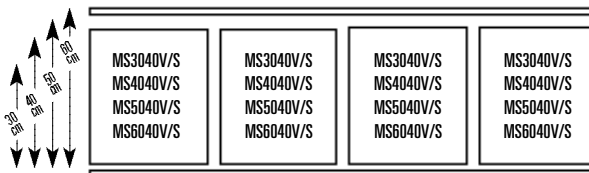

Shelf Configuration for 170 cm Traverse.

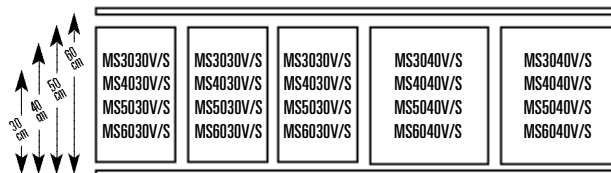

LIFETIME LIMITED WARRANTY

Cambro Manufacturing Company warranties Camshelving against rust or corrosion on traverses and stationary Camshelving posts. Camshelving Posts for Mobile Units are not warrantied against rust or corrosion. This warranty is designated for the lifetime of the Camshelving, providing the product has not been altered in any way and assuming normal and proper use and maintenance. Camshelving is designed for use in foodservice applications and is compatible with the products and cleaning agents typically used in those applications. Abuse, misuse or an act of God are not covered.

With proof of purchase to the original owner, Cambro Manufacturing Company will replace the product to the original owner. In the event of a warranty claim, please contact your local Cambro Sales Representative or the Cambro Customer Service Department at 00 31 168-413-333 or at www.cambro.com.

GENERAL MANUFACTURER'S WARRANTY

Cambro warrants to the original purchaser that all Camshelving parts are free from defects in workmanship and material. This warranty is valid for one year from the date of shipment from Cambro's distribution center and is in effect provided that the product has not been altered in any way and assuming normal and proper use and maintenance.

If any product does not meet this Warranty, Cambro will repair or replace any part it determines, upon inspection, to be defective.

CAMBRO®

INSTRUCTIONS D'ASSEMBLAGE DU SYSTÈME CAMSHELIVING®



SINGLE UNIT ASSEMBLED



SINGLE UNIT AND ADD-ON UNIT ASSEMBLED.
MIDDLE POST IS SHARED BY BOTH UNITS



SINGLE UNIT AND ADD-ON UNIT ASSEMBLED
WITH CORNER CONNECTORS.

**AVANT DE COMMENCER L'ASSEMBLAGE, LIRE LES INSTRUCTIONS.
POUR UN ASSEMBLAGE CORRECT, UTILISER UN MAILLET EN CAOUTCHOUC – NE JAMAIS UTILISER UN MARTEAU!**

CONSEILS D'ASSEMBLAGE

- La structure originale des raccords de montants assure une stabilité transversale exceptionnelle. Cette stabilité est optimisée lorsque le rayon inférieur est aussi près que possible de l'extrémité inférieure du montant.
- Pour des raisons de sécurité, il est conseillé de charger davantage les tablettes inférieures que les tablettes supérieures.
- Pour une unité standard, à 4 montants, le système Camshelving est conçu pour une charge maximale de 200 kg par étagère de 60 à 120 cm et de 150 kg par étagère de 130 à 170 cm.
- Lors du martelage des raccords de montants et des raccords d'angle dans les montants, éviter tout montage excessivement serré.
- Dans les unités d'angle, le raccord d'angle doit soutenir une traverse plus courte. Charger davantage l'unité principale que l'unité qui lui est rattachée par des raccords d'angle.
- Dans le cas de petites unités mobiles, il est plus facile de commencer par l'assemblage de l'unité et de monter les roues en dernier lieu.

INSTRUCTIONS DE NETTOYAGE

Les surfaces du système Camshelving sont en polypropylène. Cette matière résiste aux taches et aux produits chimiques, et la plupart des produits de nettoyage communément utilisés conviennent à son entretien.

Les tablettes du système Camshelving sont amovibles et peuvent se placer dans un panier Camrack OETR314 (c'est-à-dire un égouttoir à vaisselle à extrémité ouverte) pour se nettoyer dans un lave-vaisselle commercial. Les traverses sont également amovibles et peuvent se placer directement sur le transporteur d'un lave-vaisselle.

Les montants et leurs raccords peuvent se nettoyer à la vapeur ou à la main, à l'aide d'un linge ou d'une éponge humectée d'une solution de détergent préparée conformément aux instructions du fabricant. Après ce lavage manuel, rincer à fond et essuyer les pièces pour les sécher. Si l'on ne dispose pas d'un lave-vaisselle commercial, les tablettes et traverses du système Camshelving peuvent elles aussi se nettoyer par cette méthode.

A. PRÉPARATIFS D'ASSEMBLAGE

- 1** Pour commencer, disposer l'ensemble des pièces, les identifier et les compter.

- a.** Kits de Montants: Se composent de 2 montants et d'une paire de raccords de montants.



- b.** Kit d'Étagères: Comprend 2 traverses et 1 jeu de tablettes correspondant à la longueur des traverses.

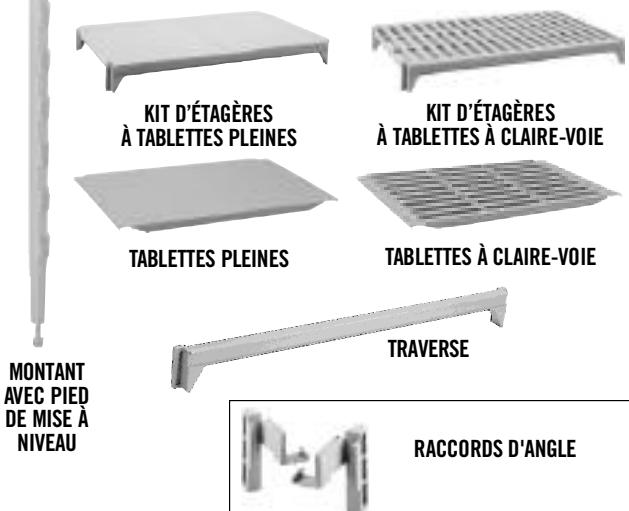

INSTRUCTIONS D'ASSEMBLAGE DU SYSTÈME CAMSHELIVING®

AVANT DE COMMENCER L'ASSEMBLAGE, LIRE LES INSTRUCTIONS.
POUR UN ASSEMBLAGE CORRECT, UTILISER UN MAILLET EN CAOUTCHOUC – NE JAMAIS UTILISER UN MARTEAU!

B. ASSEMBLAGE D'UNE UNITÉ :

1 Assemblage de l'armature à montants

- Rapprocher deux montants, les queues d'arondes se faisant face.
- Installer le raccord de montants inférieur sur les deux montants à l'aide d'un maillet.
Marteler alternativement les deux côtés jusqu'à ce que le raccord soit fermement installé.
- Installer le raccord de montants supérieur sur les deux montants.
Marteler alternativement les deux côtés jusqu'à ce que le raccord soit fermement installé.
- Reprendre la procédure pour la deuxième armature à montants.

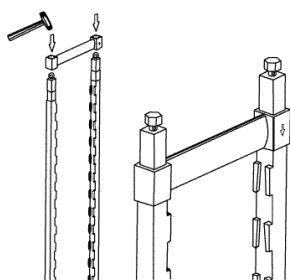

ASSEMBLAGE DE
RACCORD DE MONTANTS INFÉRIEUR

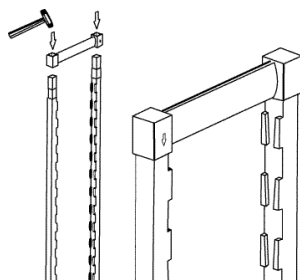

ASSEMBLAGE DE
RACCORD DE MONTANTS SUPÉRIEUR



MONTANTS ET RACCORDS DE
MONTANTS ASSEMBLÉS

2 Assemblage des traverses

- Choisir la position des rayons.
- Installer les traverses sur les montants :
 - Aligner la partie inférieure de l'ouverture en queue d'aronde avec la partie inférieure de la queue d'aronde des montants.
 - Pousser la traverse contre les montants.
 - Abaïsser la traverse.
 - Fixer la traverse en position en tapotant les deux extrémités de celle-ci à l'aide d'un maillet.
- Installer la traverse sur le côté opposé de l'armature à montants.
- Reprendre la procédure pour le restant des rayons de l'unité.

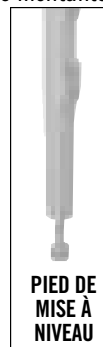

PIED DE
MISE À
NIVEAU

3 Vérifier que l'unité est à niveau. Régler au besoin le pied de mise à niveau à l'aide d'une clé plate de 24.

4 Installation des tablettes sur les traverses.

Se reporter à la page de configuration des jeux de tablettes.

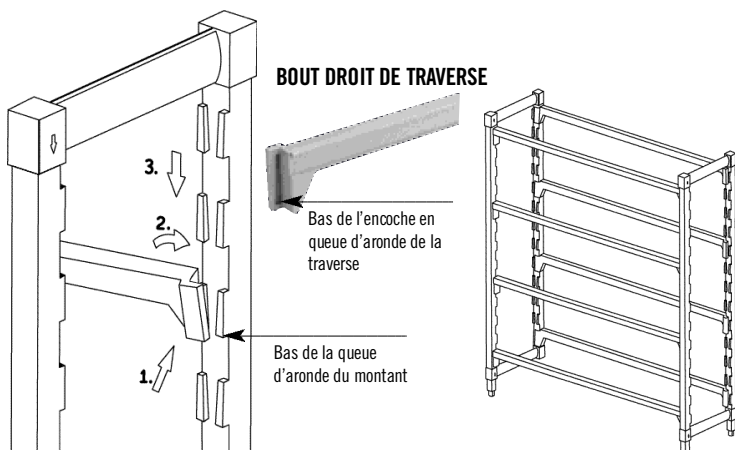

MONTAGE DES TRAVERSES

MONTAGE DE TOUTES LES TRAVERSES



POSER LES TABLETTES
SUR LES TRAVERSES

INSTRUCTIONS D'ASSEMBLAGE DU SYSTÈME CAMSHELIVING®

AVANT DE COMMENCER L'ASSEMBLAGE, LIRE LES INSTRUCTIONS.
POUR UN ASSEMBLAGE CORRECT, UTILISER UN MAILLET EN CAOUTCHOUC – NE JAMAIS UTILISER UN MARTEAU!

C. AJOUT D'UNE UNITÉ EN LIGNE DROITE

- 1 Assembler la première unité, comme décrit au point (B).
- 2 Assembler une deuxième armature à montants, comme décrit au point (B1).
- 3 Installer une traverse entre le montant de la première unité et la deuxième armature à montants.
Le montant central est commun aux traverses des première et deuxième unités.
- 4 **Vérifier que l'unité est à niveau.** Régler au besoin le pied de mise à niveau à l'aide d'une clé plate de 24.
- 5 Ajouter les tablettes sur les traverses, comme décrit ci-dessus.

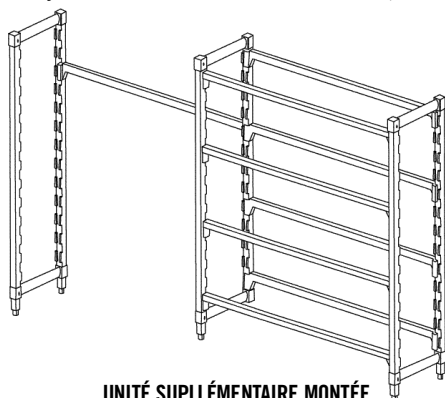

UNITÉ SUPPLÉMENTAIRE MONTÉE



UNITÉ DE BASE ET UNITÉ ADDITIONNELLE MONTÉES
LE MONTANT DU MILIEU EST COMMUN AUX DEUX UNITÉS

D. AJOUT D'UNE UNITÉ D'ANGLE (À 90°)

- 1 Assembler la première unité, comme décrit au point (B).
- 2 Assembler une deuxième armature à montants, comme décrit au point (B1).
- 3 Repérer les raccords d'angle droit et gauche et les monter sur les traverses de la première unité.
Installation des raccords d'angle :
 - a. Insérer le bord supérieur du raccord d'angle dans la rainure du bord supérieur de la traverse.
 - b. Engager le raccord sur le bord inférieur de la traverse, d'un coup sec.
 - c. Positionner le raccord à l'emplacement de la traverse qui correspond à la largeur de la deuxième unité.
- 4 Reprendre la procédure pour monter un raccord d'angle droit et gauche sur chaque rayon de la première unité.
- 5 Installer des traverses entre les raccords d'angle et l'armature à montants supplémentaire.
 - a. Les traverses s'encliquètent sur la queue d'aronde des raccords d'angle de la même manière que sur celles des montants.
- 6 **Vérifier que l'unité est à niveau.** Régler au besoin le pied de mise à niveau à l'aide d'une clé plate de 24.
- 7 Ajouter les tablettes sur les traverses, comme décrit ci-dessus.



RACCORDS D'ANGLE

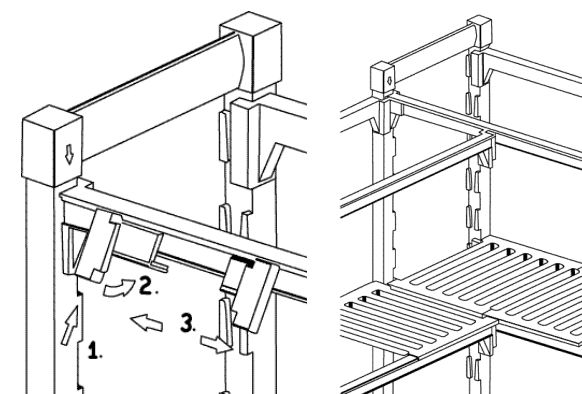

INSÉRER ET ENGAGER LE RACCORD
SUR LE BORD DE LA TRAVERSE

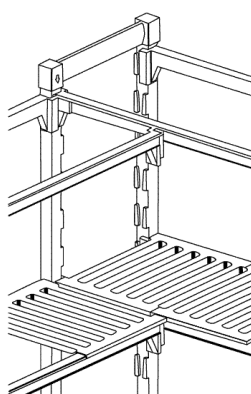

TRAVERSES MONTÉES
SUR RACCORDS D'ANGLE



Conseils d'utilisation des raccords d'angles

- Capacité de support maximum en cas d'utilisation de raccords d'angle est de **180 kg** par étagère.
- Les raccords d'angle ne peuvent être utilisés qu'avec des Traverses de **60 cm à 120 cm** maximum.
- En cas de raccordement de traverses de longueur différente, monter les raccords d'angle sur la traverse la plus longue, puis la traverse la plus courte sur les raccords d'angle.

CONFIGURATIONS DES JEUX DE TABLETTES D'ÉTAGÈRES CAMSHELVING®

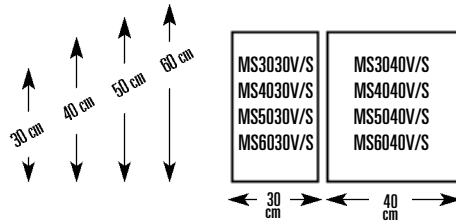

S = Tablettes Pleines ; V = Tablettes à Claire-Voie

Configuration pour traverse de 60 cm

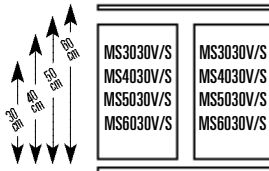

Configuration pour traverse de 70 cm

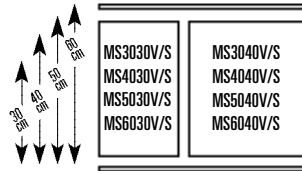

Configuration pour traverse de 80 cm

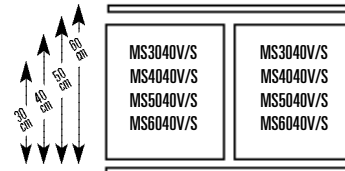

Configuration pour traverse de 90 cm

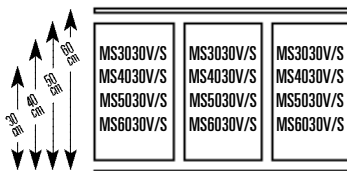

Configuration pour traverse de 100 cm

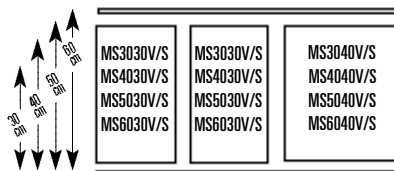

Configuration pour traverse de 110 cm

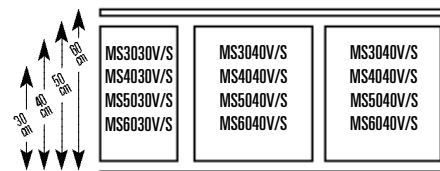

Configuration pour traverse de 120 cm

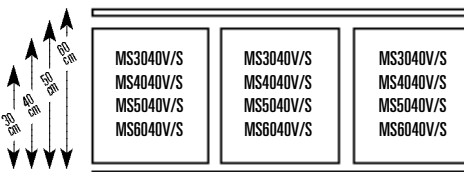

Configuration pour traverse de 130 cm

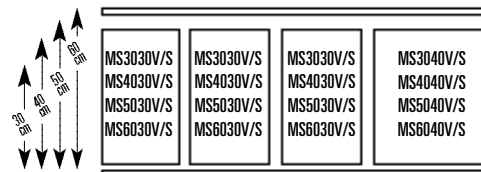

Configuration pour traverse de 140 cm

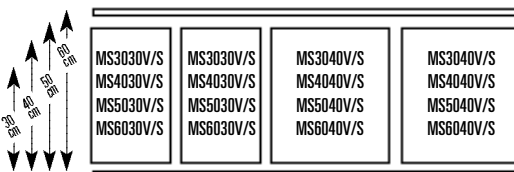

Configuration pour traverse de 150 cm

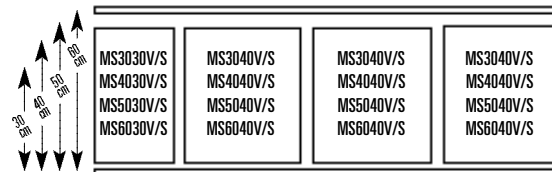

Configuration pour traverse de 160 cm

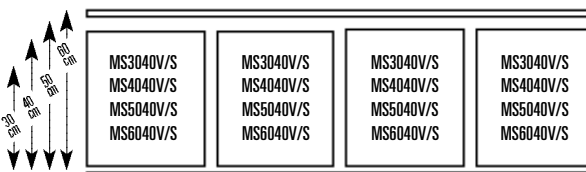

Configuration pour traverse de 170 cm

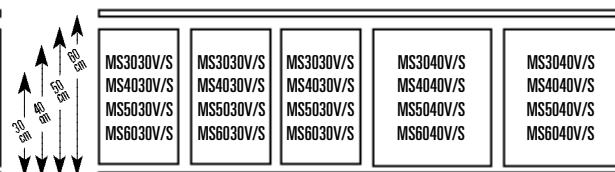

GARANTIE À VIE LIMITÉE DU SYSTÈME CAMSHELVING

Cambro Manufacturing Company garantit les montants et traverses du système Camshelving contre la rouille et la corrosion. Cette garantie s'étend à toute la durée de vie du système, sous réserve de l'utilisation et de la maintenance correctes et appropriées du produit et de l'absence de toute modification de celui-ci. Le système Camshelving est conçu pour utilisation dans le cadre de services de restauration, et est compatible avec les produits alimentaires et de nettoyage communément utilisés dans ce secteur. La garantie exclut tout usage erroné ou abusif, ainsi que les catastrophes naturelles.

Cambro Manufacturing Company s'engage à fournir un produit de remplacement à l'acheteur d'origine, sur présentation d'un justificatif d'achat. Pour tout recours en garantie, contacter le représentant Cambro le plus proche ou le service clientèle Cambro, soit par téléphone, à C.E.L. au 00 31 168-413-333, soit sur www.cambro.com.

GARANTIE DU FABRICANT

Cambro garantit les pièces du système Camshelving contre tout défaut de matière ou de fabrication. Cette garantie est accordée à l'acheteur original, pour une période d'un an à compter de la date d'expédition du centre de distribution de Cambro, sous réserve de l'utilisation et de la maintenance correctes et appropriées du produit et de l'absence de toute modification de celui-ci.

Cambro s'engage à réparer ou remplacer tout produit couvert par la présente garantie que la société estime être défectueux, ceci après inspection.

CAMBRO®

MONTAGEANLEITUNG FÜR CAMSHELIVING®



MONTIERTE EINZELINHEIT



MONTIERTE EINZEL- UND ANBAUEINHEIT.
MITTELPFOSTEN TRÄGT BEIDE EINHEITEN.



MONTIERTE EINZEL- UND ANBAUEINHEIT
MIT ECKVERBINDUNGEN.

ANWEISUNGEN VOR MONTAGE AUFMERKSAM DURCHLESEN.

ZUR VORSCHRIFTSMÄSSIGEN MONTAGE WIRD EIN GUMMI- ODER KUNSTSTOFFHAMMER BENÖTIGT - KEINEN METALLHAMMER BENUTZEN!

MONTAGETIPS

- Die unkonventionelle Bauweise der Pfostenverbindungen sorgt für außergewöhnliche Querstabilität, die sich noch verstärken läßt, indem das unterste Fach so tief wie möglich am Pfosten angebracht wird.
- Aus Sicherheitsgründen sollten schwerere Lasten in den unteren Fächern und leichtere Lasten in den oberen Fächern aufbewahrt werden.
- Normale Camshelving Regale mit vier Tragpfosten halten bei Verwendung einer 60- bis 120-cm-Querstrebe 200 kg pro Fach und bei Verwendung einer 130- bis 170-cm-Querstrebe 150 kg pro Fach aus.
- Die Rollen für Camshelving Mobileinheiten halten bis zu 340 kg pro Einheit aus.
- Mit Eckverbindungen befestigte Regalplatten haben eine max. Tragfähigkeit von 180 kg und sollten mit Querstreben von bis zu 120 cm verwendet werden.
- Bei der Montage einen Gummi- oder kunststoffhammer benutzen. Beim Anhämmern der Pfostenverbindungen und Querstreben an die Pfosten darauf achten, dass die Verbindungsstücke bündig an den Pfosten anliegen. **NICHT ZU STARK HÄMMERN.**
- Bei ECKeinheiten trägt **die Eckverbindung normalerweise den kürzeren Teil der Querverstrebung.** Schwerere Lasten auf die Haupteinheit legen, leichtere Lasten auf die mit Eckverbindungen anmontierte Einheit legen.

REINIGUNGSHINWEISE

Die Camshelving-Oberfläche ist aus Polypropylen hergestellt. Polypropylen ist flecken- und chemikalienfest und läßt sich mit den meisten gebräuchlichen Reinigungsmitteln säubern.

Die Camshelving Regalplatten können entfernt und in einem einseitig offenen Camrack OETR314-Tablettspülkorb Reinigungshinweise in einer gewerblichen Geschirrspülmaschine gespült werden. Querstreben können ebenfalls abgenommen und direkt auf einem Geschirrspülband maschinell gespült werden.

Die Pfosten und Pfostenverbindungen können mit Dampf oder per Hand mit einem Tuch oder Schwamm und Reinigungsmittel gesäubert werden. Hierzu eine Reinigungslösung gemäß Herstelleranleitung vorbereiten. Oberfläche mit einem Tuch oder Schwamm abwaschen, gründlich abspülen und trockenreiben. Falls keine gewerbliche Geschirrspülmaschine vorhanden ist, können Camshelving Regalplatten und Querstreben auf dieselbe Weise gesäubert werden.

A. VORBEREITUNG FÜR DIE MONTAGE

- 1 Zunächst alle Teile bereitlegen, identifizieren und zählen.

- a. Pfostenbausatz: Enthält 2 Tragpfosten, 1 obere Pfostenverbindung und 1 untere Pfostenverbindung.



MONTIERTER
PFOSTENBAUSATZ

- b. Fachbausätze: Enthalten 2 Querstreben und Regalplatten für die Länge der Querstreben

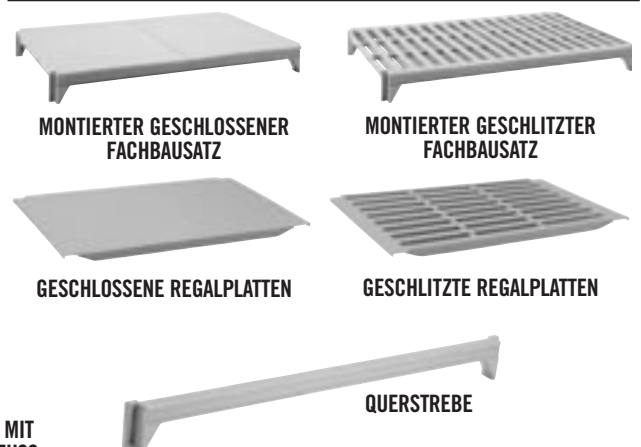

MONTIERTER GESCHLOSSENER
FACHBAUSATZ

MONTIERTER GESCHLITZTER
FACHBAUSATZ

GESCHLOSSENE REGALPLATTEN

GESCHLITZTE REGALPLATTEN

QUERSTREBE

PFOSTEN MIT
JUSTIERFUSS



ECKVERBINDUNGEN

MONTAGEANLEITUNG FÜR CAMSHELVING®

ANWEISUNGEN VOR MONTAGE AUFMERKSAM DURCHLESEN.

ZUR VORSCHRIFTSMÄSSIGEN MONTAGE WIRD EIN GUMMI- ODER KUNSTSTOFFHAMMER BENÖTIGT - KEINEN METALLHAMMER BENUTZEN!

B. MONTAGE EINER EINZELNHEIT

1 Montage der Pfostenbausätze

- Zwei Pfosten mit Schwalbenschwänzen einander gegenüberhalten.
- Die untere Pfostenverbindung den Pfeilrichtungen entsprechend mit einem Gummi- oder kunststoffhammer an den beiden Pfosten befestigen. Beide Seiten abwechselnd anhämmern, bis das Verbindungsstück gut fest sitzt.
- Die obere Pfostenverbindung am oberen Ende der beiden Pfosten befestigen. Beide Seiten abwechselnd anhämmern, bis das Verbindungsstück gut fest sitzt.
- Beim zweiten Pfostenrahmen ebenso vorgehen.

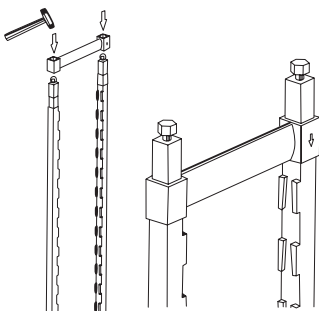

ANBRINGUNG DER UNTEREN PFOSTENVERBINDUNG

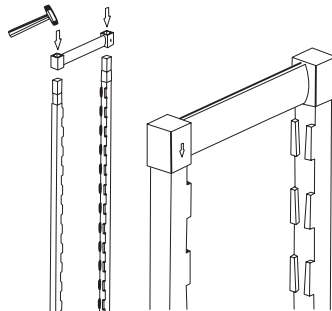

ANBRINGUNG DER OBEREN PFOSTENVERBINDUNG

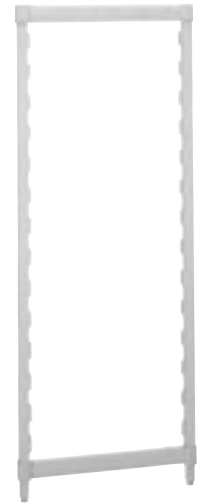

MONTIERTER PFOSTEN MIT PFOSTENVERBINDUNGEN

2 Die Querstreben anbringen

- Den Aufstellplatz für das Regal bestimmen.
- Die Querstreben an den Pfosten befestigen:
 - Den unteren Teil der Schwalbenschwanzöffnung am unteren Teil des Schwalbenschwanzes an den Pfosten ausrichten.
 - Die Querstrebe an den Pfosten andrücken.
 - Die Querstrebe nach unten absenken.
 - Beide Enden der Querstrebe mit einem Gummi- oder kunststoffhammer festklopfen.
- Die Querstrebe an der gegenüberliegenden Seite des Pfostenrahmens befestigen.



3 Sicherstellen, daß die Einheit waagrecht steht. Bei Bedarf den Justierfuß mit einem Schraubenschlüssel (15/16") entsprechend nachstellen.

4 Die Regalplatten auf die Querstreben legen.

Siehe dazu „Anordnung der Regalauflagensätze“ auf der Rückseite dieser Anleitung.

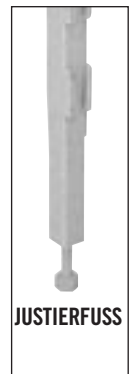

JUSTIERFUSS

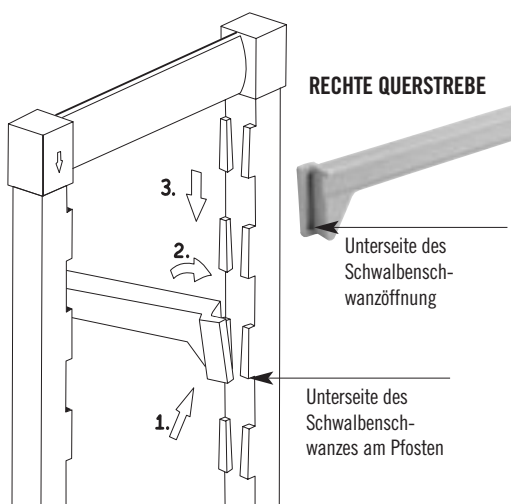

BEFESTIGUNG DER QUERSTREBEN AN DEN PFOSTEN

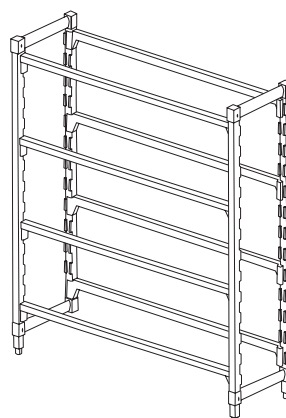

MONTIERTE QUERSTREBEN, KOMPLETT



AUFLAGE DER REGALPLATTEN AUF DIE QUERSTREBEN

MONTAGEANLEITUNG FÜR CAMSHELVING®

ANWEISUNGEN VOR MONTAGE AUFMERKSAM DURCHLESEN.

ZUR VORSCHRIFTSMÄSSIGEN MONTAGE WIRD EIN GUMMI- ODER KUNSTSTOFFHAMMER BENÖTIGT - KEINEN METALLHAMMER BENUTZEN!

C. ANBAU EINER EINHEIT IN REIHE

- 1 Die erste Einheit wie in Schritt (B) beschrieben zusammenbauen.
- 2 Einen zweiten Pfostenrahmen wie in Schritt (B1) beschrieben zusammenbauen.
- 3 Zwischen dem Pfosten der ersten Einheit und dem zweiten Pfostenrahmen eine Querstrebe befestigen. Die Querstreben der ersten und zweiten Einheit werden durch denselben Mittelpfosten getragen.
- 4 **Sicherstellen, daß die Einheit waagrecht steht.** Bei Bedarf den Justierfuß mit einem Schraubenschlüssel (15/16") nachstellen.
- 5 Die Regalplatten auf die Querstreben legen.

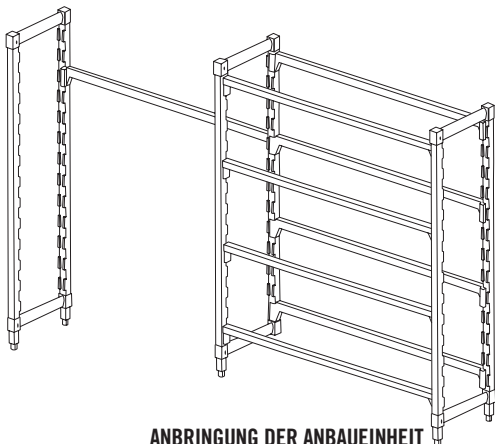

ANBRINGUNG DER ANBAUEINHEIT



MONTIERTE EINZEL- UND ANBAUEINHEIT.
MITTELPFOSTEN TRÄGT BEIDE EINHEITEN.

D. ANBAU EINER EINHEIT IM 90°-WINKEL

- 1 Die erste Einheit wie in Schritt (B) beschrieben zusammenbauen.
- 2 Einen zweiten Pfostenrahmen wie in Schritt (B1) beschrieben zusammenbauen.
- 3 Die rechten und linken Eckverbindungen ermitteln und an den Querstreben der ersten Einheit befestigen.
Anbringen der Eckverbindungen:
 - a. Die Oberkante der Eckverbindung in die Rille an der Oberkante der Querstrebe einsetzen.
 - b. Die Eckverbindung an den Kanten der Querstrebe festdrücken.
 - c. Die Eckverbindung zur richtigen Stelle an der Querstrebe schieben, damit der Breite der zweiten Einheit entsprochen wird.
- 4 An jedem Regal der ersten Einheit ebenfalls eine rechte und linke Querverbindung anbringen.
- 5 Querstreben zwischen den Eckverbindungen und dem zweiten Pfostenrahmen befestigen.
 - a. Die Querstreben rasten (wie auf den Schwalbenschwänzen der Pfosten) auf dem Schwalbenschwanz der Eckverbindungen ein.
- 6 **Sicherstellen, daß die Einheit waagrecht steht.** Bei Bedarf den Justierfuß mit einem Schraubenschlüssel (15/16") nachstellen.
- 7 Die Regalplatten auf die Querstreben legen.



ECKVERBINDUNGEN

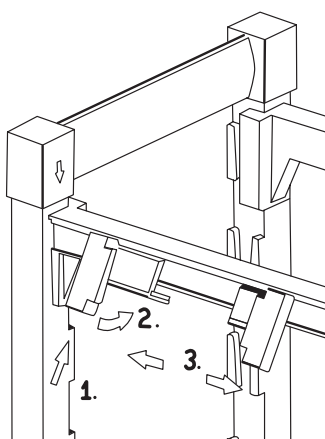

SNAPPVERBINDUNGEN
DER QUERSTREBE

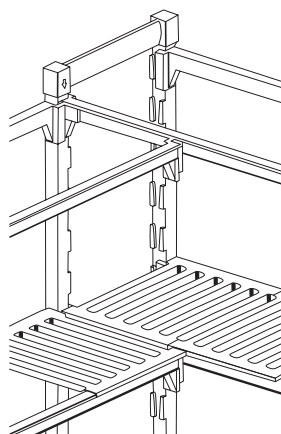

BEFESTIGUNG DER QUERSTREBEN



CAMBRO Eckverbindungen - Hilfreiche Tips

- Mit Eckstücken verbundene Regale haben eine max. Tragfähigkeit von 180 kg.
- Mit Camshelving®-Eckverbindungen verbundene Querstreben sollten nur bis zu 120 cm lang sein.
- Bei Verbindung von Querstreben verschiedener Länge, die Eckverbindungen zunächst an den längeren Querstreben, und die kürzeren Querstreben danach an den Eckverbindungen befestigen.

ANORDNUNG DER CAMSHELIVING®-REGALAUFLAGENSÄTZE

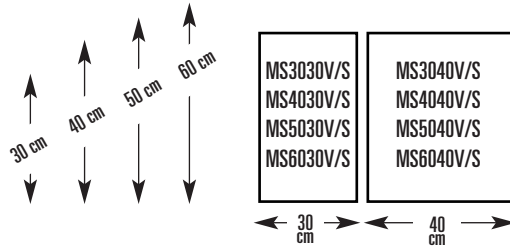

S bzw. V bedeuten geschlossene bzw. geschlitzte Regalauflagensätze

Anordnung für 60-cm-Querstreben

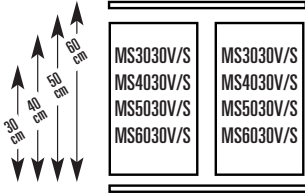

Anordnung für 70-cm-Querstreben

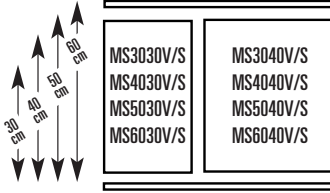

Anordnung für 80-cm-Querstreben

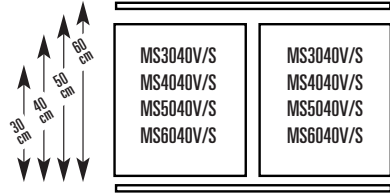

Anordnung für 90-cm-Querstreben

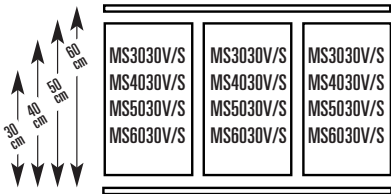

Anordnung für 100-cm-Querstreben

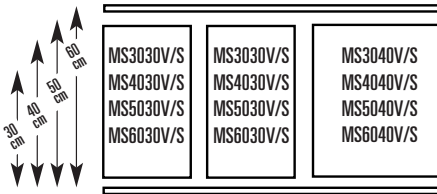

Anordnung für 110-cm-Querstreben

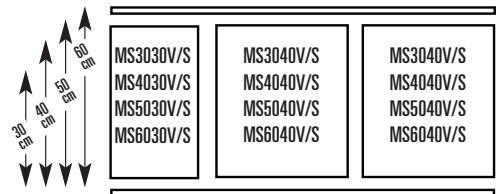

Anordnung für 120-cm-Querstreben

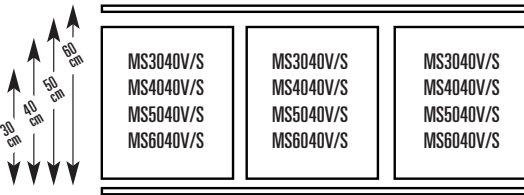

Anordnung für 130-cm-Querstreben

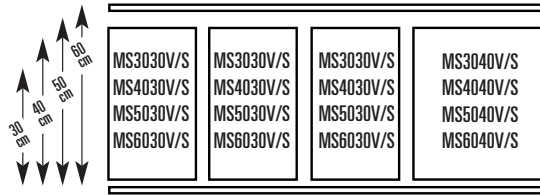

Anordnung für 140-cm-Querstreben

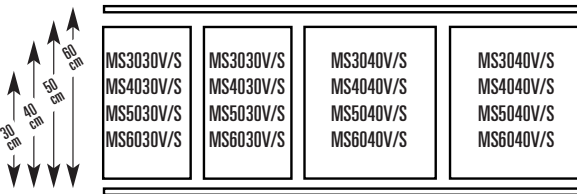

Anordnung für 150-cm-Querstreben

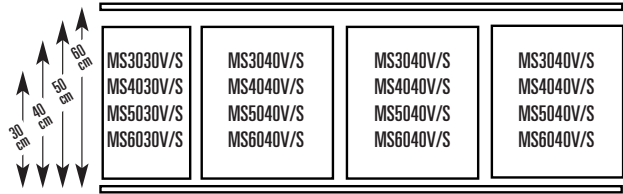

Anordnung für 160-cm-Querstreben

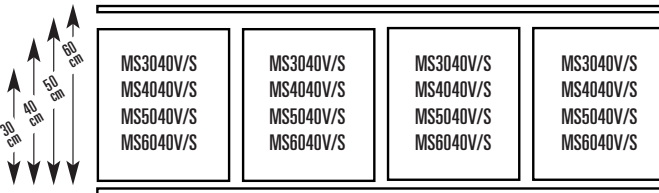

Anordnung für 170-cm-Querstreben

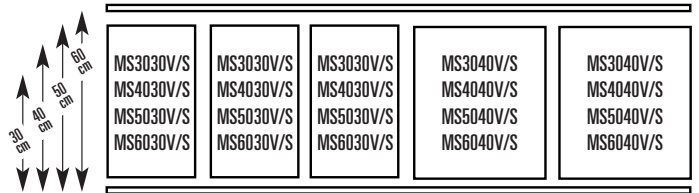

LEBENS-LANGE BEGRENZTE GARANTIE

Cambro Manufacturing Company garantiert Rost- und Korrosionsfreiheit für Camshelving-Querstreben und stationäre Pfosten. Für mobile Camshelving-Einheiten wird keine Rost- bzw. Korrosionsfreiheit garantiert. Diese Garantie gilt für die Lebensdauer von Camshelving, vorausgesetzt, das Produkt wurde normaler Verwendung und Wartung unterzogen und nicht auf irgendeine Weise modifiziert. Camshelving ist für die Verwendung in der Gastronomie vorgesehen und mit Produkten und Reinigungsmitteln kompatibel, die in diesem Bereich üblich sind. Zweckentfremdung, Mißbrauch und höhere Gewalt sind von der Garantie ausgeschlossen.

Cambro Manufacturing Company tauscht dem Originalkäufer unter Vorlage der Kaufquittung das Produkt um. Setzen Sie sich bei Garantieforderungen mit dem zuständigen Cambro-Vertreter oder dem Cambro-Kundendienst, Rufnummer 0049 7024 9721 0 oder über www.cambro.com in Verbindung.

HERSTELLERGARANTIE

Cambro garantiert dem Originalkäufer, daß alle Camshelving™ Teile frei von Herstellungs- und Materialmängeln sind. Diese Garantie gilt bis zu einem Jahr ab dem Versand ab Cambro Vertriebszentrum bei normaler, sachgerechter Verwendung und Wartung, vorausgesetzt, das Produkt wurde nicht auf irgendeine Weise modifiziert.

Falls ein Produkt dieser Garantie nicht entspricht, kann es Cambro zu einer Inspektion überlassen werden. Teile, die als defekt befunden werden, werden repariert oder ausgetauscht.



Für Nahrungsmittel geeignet



Ohne Kadmium



Für recycling geeignetes Polypropylen



CAMBRO®

ISTRUZIONI PER L'ASSEMBLAGGIO DEL CAMSHELVING®



UNITÀ BASE ASSEMBLATA



UNITÀ BASE E UNITÀ ADDIZIONALE ASSEMBLATE.
IL MONTANTE CENTRALE È CONDIVISO DA ENTRAMBE LE UNITÀ



UNITÀ BASE E UNITÀ ADDIZIONALE ASSEMBLATE
CON CONNETTORI PER ANGOLI.

**LEGGERE LE ISTRUZIONI PRIMA D'INIZIARE L'ASSEMBLAGGIO.
PER UN ASSEMBLAGGIO CORRETTO, USARE UN MAZZUOLO DI GOMMA E MAI UN MARTELLLO DI FERRO!**

CONSIGLI PER L'ASSEMBLAGGIO

- L'esclusiva progettazione dei connettori per montanti garantisce la massima stabilità della scaffalatura. Una stabilità ancora maggiore può essere ottenuta posizionando il ripiano inferiore il più vicino possibile alla base del montante.
- Per motivi di sicurezza, mettere gli oggetti più pesanti sui ripiani inferiori e quelli più leggeri sui ripiani superiori.
- La scaffalatura Camshelving può sopportare un peso totale di 200 kg per ripiano usando traverse di 60-120 cm, e 150 kg con traverse di 130-170 cm, su una unità standard a 4 montanti.
- Le ruote orientabili delle unità mobili Camshelving possono sopportare un peso di 340 kg per unità.
- I ripiani uniti con un connettore per angoli possono sopportare fino a 180 kg di peso e devono essere usati su traverse di misura non superiore a 120 cm.
- Per l'assemblaggio, usare un mazzuolo di gomma. Nel battere i connettori per montanti e le traverse sui montanti, accertarsi che i connettori per montanti siano completamente inseriti nei montanti. **NON BATTERE OLTRE IL NECESSARIO.**
- Quando si assemblano unità ad angolo, è sempre consigliato porre il **connettore per angolo sulla traversa più lunga in modo che il connettore stesso sostenga il peso della traversa più corta.** Mettere gli oggetti più pesanti sull'unità principale, quelli più leggeri sull'unità collegata con i connettori per angoli.

ISTRUZIONI PER LA PULIZIA

La superficie del Camshelving è in polipropilene, e pertanto è resistente alle macchie e alle sostanze chimiche; la superficie può essere pulita con i detersivi più comuni.

I ripiani del Camshelving possono essere rimossi, messi nel cestello per piatti a lato aperto Camrack OETR314 e lavati in lavastoviglie. Anche le traverse possono essere rimosse e lavate in una lavastoviglie a nastro.

I montanti e i relativi connettori possono essere puliti a vapore o a mano usando un detersivo e un panno o una spugna. Per quest'operazione di pulizia, preparare la soluzione detersiva seguendo le istruzioni della casa produttrice del detersivo. Lavare la superficie con un panno o una spugna, sciacquare a fondo e asciugare con un panno. Se non si dispone di una lavastoviglie industriale, anche i ripiani e le traverse Camshelving possono essere lavati in questo modo.

A. PREPARATIVI PER L'ASSEMBLAGGIO

1 Prima di tutto, identificare, contare e configurare le parti

a. Kit per montanti: Includono 2 montanti, 1 Connettore superiore per montanti e 1 Connettore inferiore per montanti



b. Kit per piani: Includono 2 Traverse e ripiani per coprire la lunghezza delle traverse



ISTRUZIONI PER L'ASSEMBLAGGIO DEL CAMSHELVING®

LEGGERE LE ISTRUZIONI PRIMA D'INIZIARE L'ASSEMBLAGGIO.
PER UN ASSEMBLAGGIO CORRETTO, USARE UN MAZZUOLO DI GOMMA E MAI UN MARTELLO DI FERRO!

B. PER ASSEMBLARE UNA UNITÀ BASE

1 Assemblare il kit per montanti

- Tenere due montanti con i giunti a coda di rondine rivolti l'uno verso l'altro.
- Inserire i due montanti nel connettore inferiore nella direzione indicata dalla freccia, stampata sul connettore stesso. Con un mazzuolo di gomma, battere alternativamente ogni lato fino a quando il connettore sarà fissato saldamente.
- Montare il connettore superiore dei montanti sui due montanti. Battere alternativamente ogni lato fino a quando il connettore sarà fissato saldamente.
- Ripetere l'operazione per il secondo kit per montanti.

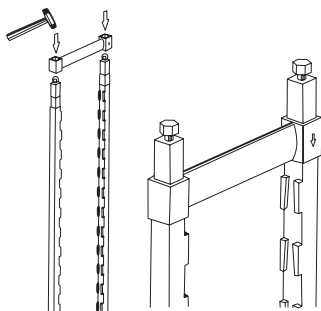

MONTARE IL CONNETTORE INFERIORE

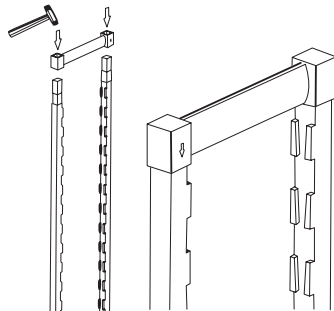

MONTARE IL CONNETTORE SUPERIORE



MONTANTE ASSEMBLATO CON I CONNETTORI DEL MONTANTE

2 Montare le traverse

- Scegliere la posizione dei ripiani
- Montare le traverse sui montanti:
 - Allineare la base dell'apertura a coda di rondine della traversa con la base del giunto a coda di rondine dei montanti (vedere figura sotto).
 - Premere la traversa contro i montanti.
 - Abbassare la traversa.
 - Fissare in posizione colpendo col mazzuolo di gomma le due estremità della traversa.
- Montare la traversa sul lato opposto e parallelo.



3 Accertarsi che l'unità sia livellata. Se necessario, variare l'altezza del piede regolabile usando una chiave inglese (15/16").

4 Mettere i ripiani sulle traverse.

Vedere Configurazioni dei kit di ripiani sul retro di copertina di queste istruzioni per l'assemblaggio.

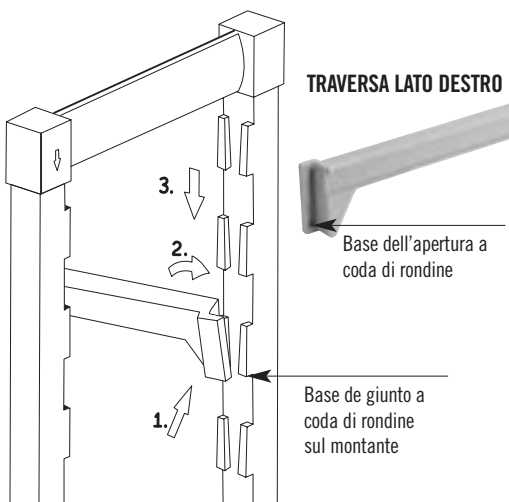
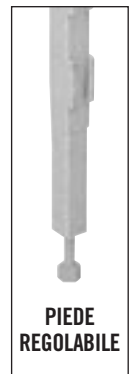

MONTARE LE TRAVERSE SUI MONTANTI

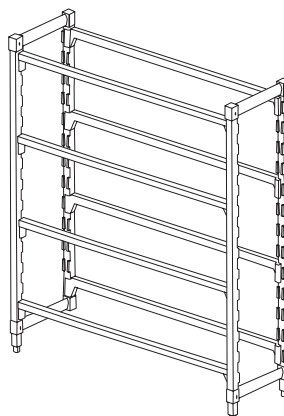

TUTTE LE TRAVERSE MONTATE



METTERE I RIPIANI SULLE TRAVERSE

ISTRUZIONI PER L'ASSEMBLAGGIO DEL CAMSHELVING®

LEGGERE LE ISTRUZIONI PRIMA D'INIZIARE L'ASSEMBLAGGIO.
PER UN ASSEMBLAGGIO CORRETTO, USARE UN MAZZUOLO DI GOMMA E MAI UN MARTELLINO DI FERRO!

C. AGGIUNTA DI UNA UNITÀ IN LINEA RETTA

- 1 Assemblare l'unità base come descritto precedentemente (B).
- 2 Assemblare un altro kit di montanti come descritto precedentemente (B1).
- 3 Montare la traversa fra il montante dell'unità base ed la spalla dell'unità addizionale.
Le traverse della prima e della seconda unità condividono il montante centrale.
- 4 **Accertarsi che l'unità sia livellata.** Se necessario, variare l'altezza del piede regolabile usando una chiave inglese (15/16").
- 5 Aggiungere i ripiani sulle traverse.

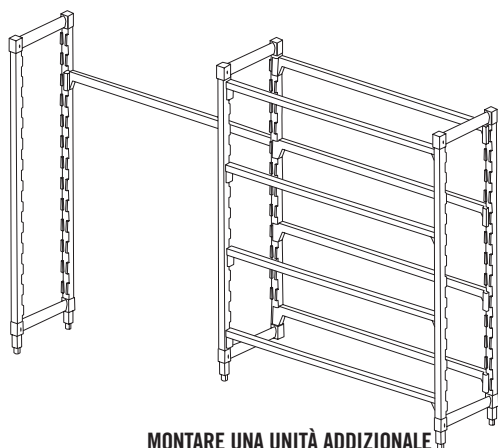

MONTARE UNA UNITÀ ADDIZIONALE



UNITÀ SINGOLA E UNITÀ ADDIZIONALE ASSEMBLATE.
IL MONTANTE CENTRALE È CONDIVISO DA ENTRAMBE LE UNITÀ

D. AGGIUNTA DI UNA UNITÀ AD ANGOLO DI 90 GRADI

- 1 Assemblare l'unità base come descritto precedentemente (B).
- 2 Assemblare un altro kit di montanti come descritto precedentemente (B1).
- 3 Identificare i connettori per gli angoli sinistro e destro e montarli sulla traversa dell'unità base.
Per montare i connettori per angoli:
 - a. Inserire il bordo superiore del connettore per gli angoli nella scanalatura del bordo superiore della traversa (vedere foto sotto).
 - b. Abbassare e far scattare il connettore sul bordo inferiore della traversa.
 - c. Spostare il connettore lungo la traversa, nella posizione appropriata e in corrispondenza con la profondità dell'unità addizionale.
- 4 Ripetere l'operazione di montaggio del connettore per angoli destro e sinistro su ciascun ripiano dell'unità base.
- 5 Montare le traverse fra i connettori per angoli la spalla dell'unità addizionale.
 - a. Le traverse si fissano in posizione sulla coda di rondine dei connettori per angoli proprio come sulle code di rondine dei montanti.
- 6 **Accertarsi che l'unità sia livellata.** Se necessario, variare l'altezza del piede regolabile usando una chiave inglese (15/16").
- 7 Aggiungere i ripiani sulle traverse.



CONNETTORI PER ANGOLI

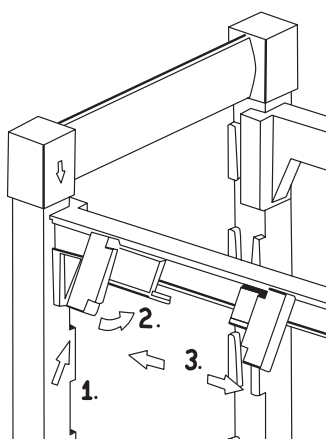

FISSARE A SCATTO IL CONNETTORE
PER ANGOLI SULLA TRAVERSA

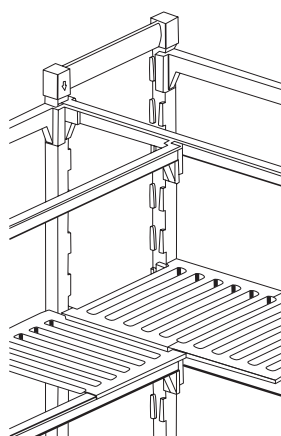

MONTARE LE TRAVERSE



Consigli utili per i connettori per angoli CAMBRO

- La capacità massima di portata dei ripiani collegati con i connettori per angoli è di 180 kg.
- La lunghezza delle traverse collegate con i connettori per angoli Camshelving® non deve superare 120 cm.
- Se vengono collegate traverse di lunghezze diverse, montare i connettori per angoli sulle traverse più lunghe e montare le traverse più corte sui connettori per angoli.

CONFIGURAZIONI DEI KIT DI RIPIANI CAMSHELVING®

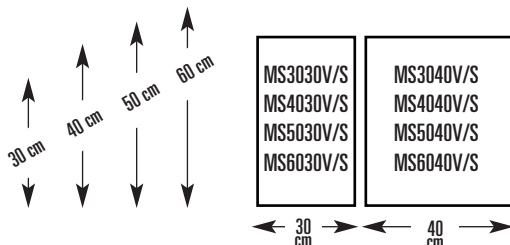

S o V indicano il ripiano Liscio o Grigliato

Configurazione del ripiano per la traversa da 60 cm

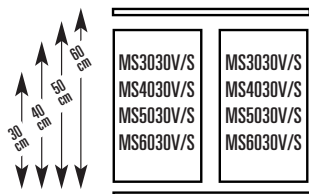

Configurazione del ripiano per la traversa da 70 cm

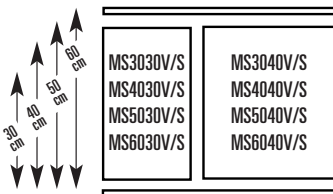

Configurazione del ripiano per la traversa da 80 cm

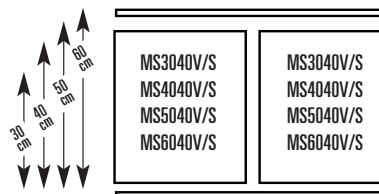

Configurazione del ripiano per la traversa da 90 cm

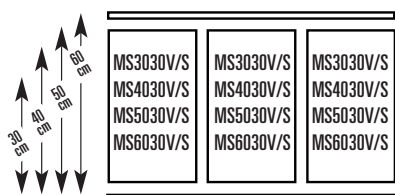

Configurazione del ripiano per la traversa da 100 cm

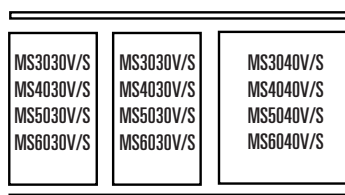

Configurazione del ripiano per la traversa da 110 cm

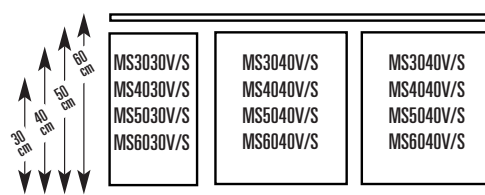

Configurazione del ripiano per la traversa da 120 cm

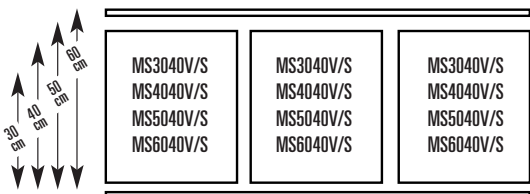

Configurazione del ripiano per la traversa da 130 cm

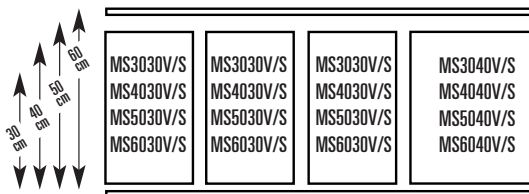

Configurazione del ripiano per la traversa da 140 cm

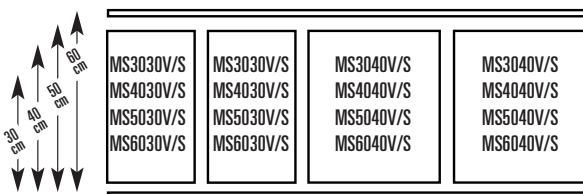

Configurazione del ripiano per la traversa da 150 cm



Configurazione del ripiano per la traversa da 160 cm

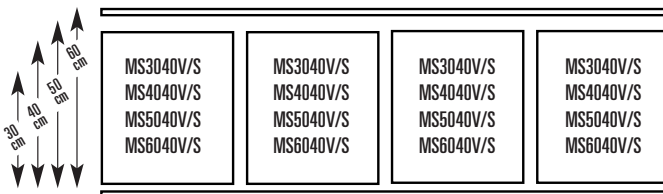

Configurazione del ripiano per la traversa da 170 cm

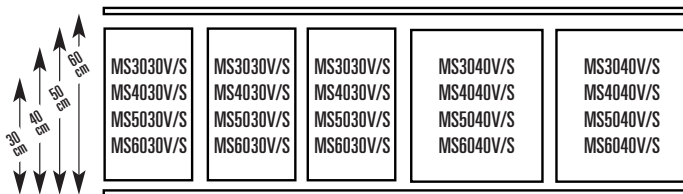

GARANZIA LIMITATA PER LA DURATA UTILE DEL PRODOTTO

La Cambro Manufacturing Company garantisce il Camshelving contro ruggine o corrosione su traverse e montanti fissi Camshelving. I montanti Camshelving per le unità mobili non sono garantiti contro la ruggine o la corrosione. Questa garanzia si estende per la durata utile del prodotto, ammesso che questo non sia stato alterato in alcun modo e venga usato e mantenuto in modo normale e appropriato. Il Camshelving è concepito e realizzato per l'uso in impieghi del settore servizi alimentari ed è compatibile con i prodotti e gli agenti detergenti normalmente usati nelle suddette applicazioni. Casi di abuso, uso improprio o di forza maggiore non sono coperti da questa garanzia.

Esibendo la prova originale d'acquisto, la Cambro Manufacturing Company fornirà all'acquirente originale un prodotto sostitutivo. Per la richiesta del servizio di garanzia, rivolgersi al rappresentante di vendita locale della Cambro, telefonare al Servizio Clienti della Cambro al numero 00 31 168-413-333 oppure visitare il sito web www.cambro.com.

GARANZIA DEL PRODUTTORE

La Cambro garantisce all'acquirente originale che tutte le parti Camshelving™ sono prive di difetti nei materiali e nella fabbricazione. La garanzia è valida per un anno dalla data di consegna dal centro di distribuzione Cambro e rimane valida ammesso che il prodotto non sia stato alterato in alcun modo e venga usato e mantenuto in modo normale e appropriato.

Se un prodotto non soddisfa questa Garanzia, la Cambro riparerà o sostituirà qualsiasi parte che, a seguito di ispezione, viene trovata difettosa.



Adatto per prodotti alimentari



Senza Cadmio



Polipropilene riciclabile





Cambro European Logistics

Kelterstrasse 51
72669
Unterensingen
Germany

Customer Service:

General:

Phone: +49 7022 90 100 0
Fax: +49 7022 90 100 19
cambroeuropa@cambro.com

France

Tel. numero vert: 0800 91 08 78
Fax: 01 72 70 35 82
cambrofrance@cambro.com

Italia

Tel. numero verde: 800 979 141
Fax: 02 4438 6047
cambroitaly@cambro.com

Ireland

Toll free phone: 1800 509 046
Fax: 01 633 5576
cambroireland@cambro.com

UK and Northern Ireland

Toll free phone: 0800 587 0057
Fax: 0845 280 3411
cambrouk@cambro.com



**Instrucciones de montaje para Camshelving®
Página 2**

**Monteringsinstruktion för Camshelving®
Sida 6**

**Montagehandleiding voor Camshelving®
Zijkant 10**

**Monteringsanvisning for Camshelving®
Side 14**



CAMBRO®

INSTRUCCIONES DE MONTAJE PARA CAMSHELIVING®



UNIDAD INDIVIDUAL MONTADA



UNIDAD INDIVIDUAL Y ADOSADA MONTADA.
EL POSTE CENTRAL SOPORTA AMBAS UNIDADES.



UNIDAD INDIVIDUAL Y ADOSADA MONTADA
CON CONEXIONES DE ESQUINA.

LEER LAS INSTRUCCIONES ATENTAMENTE ANTES DEL MONTAJE:
PARA EL MONTAJE DE ACUERDO CON LAS INSTRUCCIONES SE REQUIERE UN MARTILLO DE GOMA O DE PLÁSTICO -
NO USAR UN MARTILLO DE METAL

RECOMENDACIONES PARA EL MONTAJE

- El modo de montaje no convencional de las conexiones de los postes provee una extraordinaria estabilidad transversal que puede aumentarse aún más, si el panel más bajo se fija a la menor altura posible en el poste.
- Por razones de seguridad, las cargas más pesadas deberían almacenarse en los paneles inferiores y las cargas más livianas en los paneles superiores.
- Los estantes Camshelving normales con cuatro postes de soporte pueden soportar 200 kg por panel si se usa una traviesa de 60 a 120 cm y pueden soportar 150 kg por panel si se usa una traviesa de 130 a 170 cm.
- Los rodillos para las unidades móviles Camshelving pueden soportar hasta 340 kg por unidad.
- Los anaqueles fijados con conexiones de esquina tienen una capacidad portante máxima de 180 kg y deberían usarse con traviesas de hasta 120 cm.
- Para el montaje debe usarse un martillo de goma o de plástico. Al martillar las conexiones de poste y las traviesas a los postes, procure que las piezas de conexión estén en contacto a ras con los postes. **NO MARTILLAR CON DEMASIADA FUERZA.**
- En unidades esquineras, la conexión de esquina normalmente soporta la parte más corta de la traviesa. Colocar las cargas pesadas en la unidad principal, colocar cargas más livianas en la unidad adosada con conexiones de esquina.

INSTRUCCIONES DE LIMPIEZA

La superficie Camshelving está hecha de polipropileno. El polipropileno es resistente a las manchas y a los productos químicos y se puede limpiar con la mayoría de los productos limpiadores domésticos. Los anaqueles Camshelving pueden removerse y lavarse en una cesta de lavado de bandejas Camrack OETR314 en una máquina lavavajillas industrial. Las traviesas también se pueden remover para lavarlas a máquina directamente sobre una cinta de lavavajillas. Los postes y las conexiones de poste se pueden limpiar con vapor o de forma manual con un paño o una esponja y un producto limpiador. Para ello debe prepararse una solución limpiadora de acuerdo con las instrucciones del fabricante. Lavar la superficie con un paño o una esponja, enjuagar a fondo y secar frotando. Si no se dispone de una máquina lavavajillas industrial, los anaqueles y traviesas Camshelving se pueden limpiar de la misma manera.

A. PREPARACIÓN PARA EL MONTAJE

1 En primer lugar, prepare y cuente todas las piezas.

a. Juego de piezas de postes: Contiene 2 postes de soporte, 1 conexión de poste superior y 1 conexión de poste inferior.

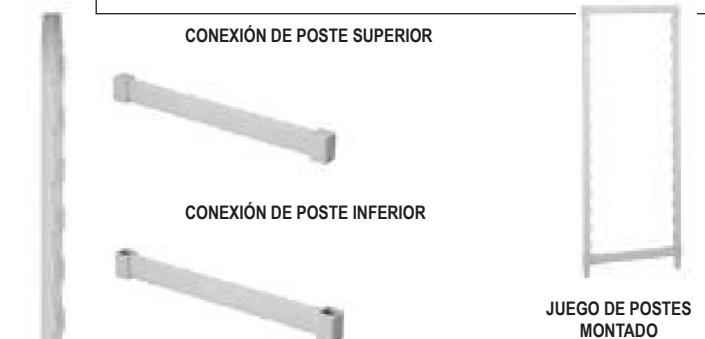

b. Juegos de elementos de entramado: Contienen 2 traviesas y anaqueles para la longitud de las traviesas



INSTRUCCIONES DE MONTAJE PARA CAMSHELVING®

LEER LAS INSTRUCCIONES ATENTAMENTE ANTES DEL MONTAJE.
PARA EL MONTAJE DE ACUERDO CON LAS INSTRUCCIONES SE REQUIERE UN MARTILLO DE GOMA O DE PLÁSTICO -
NO USAR UN MARTILLO DE METAL!

B. MONTAJE DE UNA UNIDAD INDIVIDUAL

1 Montaje de los juegos de postes

- Sostener dos postes con las colas de milano mutuamente opuestas.
- Fijar la unión de postes inferior en ambos postes conforme a las direcciones indicadas por las flechas usando un martillo de goma o de plástico. Martillar ambos lados de manera alternada, hasta que la pieza de unión quede bien fija.
- Fijar la unión de postes superior en el extremo superior de los dos postes. Martillar ambos lados de manera alternada, hasta que la pieza de unión quede bien fija.
- Proceder de la misma manera en el segundo bastidor de postes.

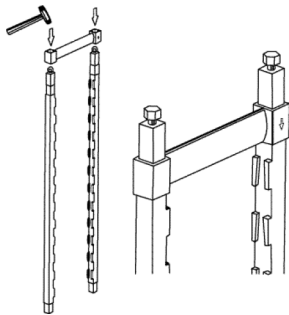

FIJACIÓN DE LA UNIÓN DE POSTES INFERIOR

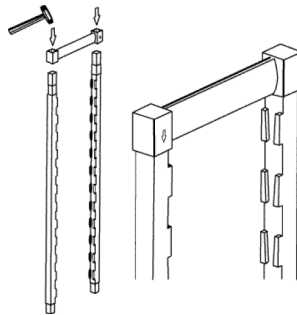

FIJACIÓN DE LA UNIÓN DE POSTES SUPERIOR



POSTE MONTADO CON UNIONES DE POSTE

2 Colocar las traviesas

- Determinar el sitio de emplazamiento del estante.
- Sujetar las traviesas en los postes:
 - Orientar la parte inferior de la abertura de cola de milano en la parte inferior de la cola de milano en los postes.
 - Presionar la traviesa contra los postes.
 - Empujar la traviesa hacia abajo.
 - Fijar los dos extremos de la traviesa con un martillo de goma o de plástico.
- Sujetar la traviesa en el lado opuesto del bastidor de postes.



3 Asegúrese de que la unidad quede horizontalmente nivelada. Si es necesario, ajustar el pie ajustable de manera correspondiente con una llave (15/16").

4 Colocar los anaqueles sobre las traviesas.

Véase "Disposición de los juegos de anaqueles de estante" al dorso de estas instrucciones.

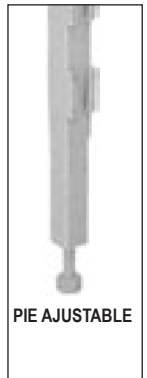

PIE AJUSTABLE

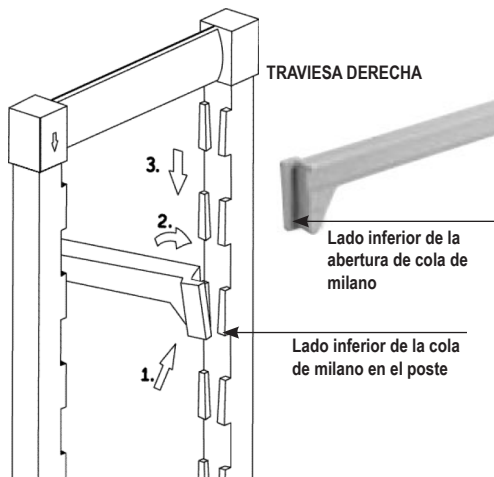

SUJECIÓN DE LAS TRAVIESAS EN LOS POSTES

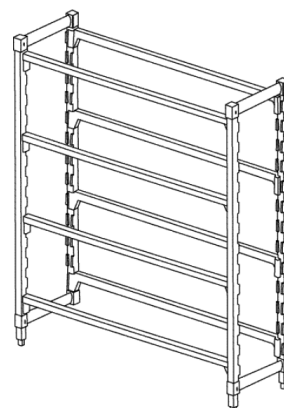

TRAVIESAS MONTADAS, COMPLETAS

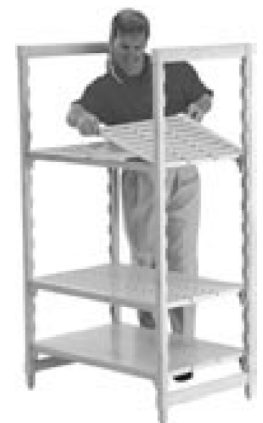

COLOCACIÓN DE LOS ANAQUELES SOBRE LAS TRAVIESAS

INSTRUCCIONES DE MONTAJE PARA CAMSHELIVING®

LEER LAS INSTRUCCIONES ATENTAMENTE ANTES DEL MONTAJE:
PARA EL MONTAJE DE ACUERDO CON LAS INSTRUCCIONES SE REQUIERE UN MARTILLO DE GOMA O DE PLÁSTICO -
NO USAR UN MARTILLO DE METAL!

C. ADOSADO DE UNA UNIDAD EN SERIE

- 1 Ensamblar la primera unidad como se ha descrito en el paso (B).
- 2 Ensamblar un segundo bastidor de postes como se ha descrito en el paso (B1).
- 3 Sujeter una traviesa entre el poste de la primera unidad y el segundo bastidor de postes.
Las traviesas de la primera y de la segunda unidad son soportadas por el mismo poste central.
- 4 Asegúrese de que la unidad quede horizontalmente nivelada. Si es necesario, ajustar el pie ajustable con una llave (15/16").
- 5 Colocar los anaqueles sobre las traviesas.

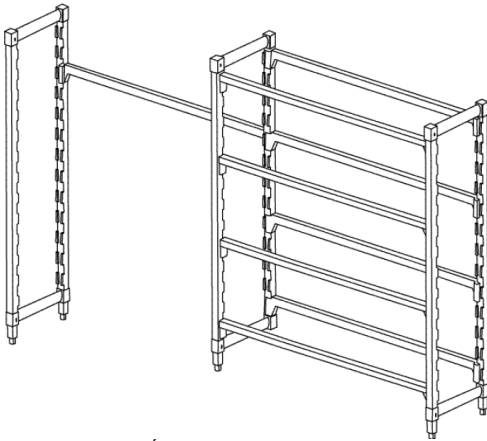

INSTALACIÓN DE LA UNIDAD ADOSADA



UNIDAD INDIVIDUAL Y ADOSADA MONTADA:
EL POSTE CENTRAL SOPORTA AMBAS UNIDADES.

D. ADOSADO DE UNA UNIDAD EN ÁNGULO DE 90°

- 1 Ensamblar la primera unidad como se ha descrito en el paso (B).
- 2 Ensamblar un segundo bastidor de postes como se ha descrito en el paso (B1).
- 3 Determinar las conexiones de esquina derecha e izquierda y sujetar en las traviesas de la primera unidad. *Montaje de las conexiones de esquina:*
 - a. Insertar el borde superior de la conexión de esquina dentro de la ranura en el borde superior de la traviesa.
 - b. Apretar la conexión de esquina en los bordes de la traviesa.
 - c. Desplazar la conexión de esquina al sitio correcto en la traviesa, para que corresponda a la anchura de la segunda unidad.
- 4 En cada estante de la primera unidad debe instalarse igualmente una unión transversal derecha e izquierda.
- 5 Fijar las traviesas entre las conexiones de esquina y el segundo bastidor de postes.
 - a. Las traviesas encajan (al igual que en las colas de milano de los postes) en la cola de milano de las conexiones de esquina.
- 6 Asegúrese de que la unidad quede horizontalmente nivelada. Si es necesario, ajustar el pie ajustable con una llave (15/16").
- 7 Colocar los anaqueles sobre las traviesas.



CONEXIONES
DE ESQUINA

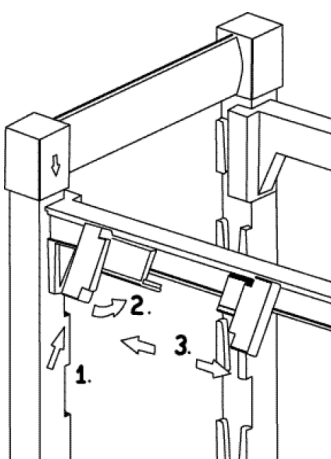

UNIONES DE CONEXIÓN RÁPIDA
DE LA TRAVIESA

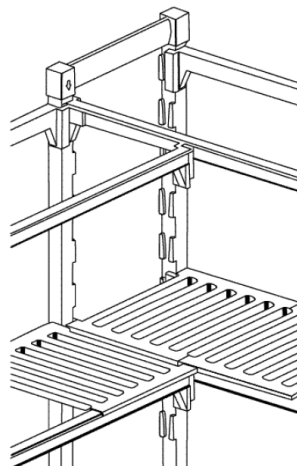

SUJECIÓN DE LAS TRAVIESAS



Conexiones de esquina CAMBRO - Consejos útiles

- Los estantes unidos mediante piezas de esquina tienen una capacidad portante máxima de 180 kg.
- Las traviesas unidas mediante conexiones de esquina Camshelving® solo deberían tener una longitud de hasta 120 cm.
- Si se unen traviesas de diferente longitud, las conexiones de esquina primero deben fijarse en las traviesas más largas y después se fijan las traviesas más cortas en las conexiones de esquina.

DISPOSICIÓN DE LOS JUEGOS DE ANAQUELES DE ESTANTE CAMSHELIVING®

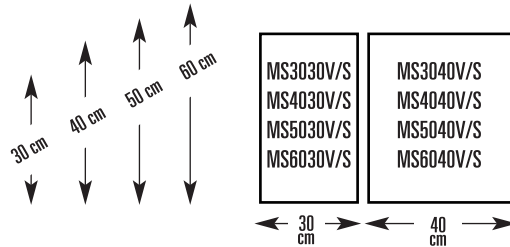

S o V se refieren a juegos de anaqueles de estante cerrados o ranurados

Disposición para traviesas de 60 cm

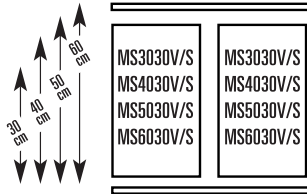

Disposición para traviesas de 70 cm

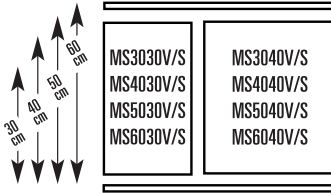

Disposición para traviesas de 80 cm

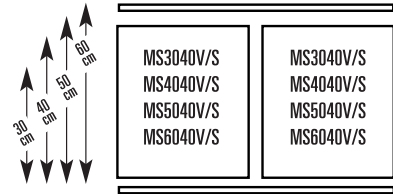

Disposición para traviesas de 90 cm

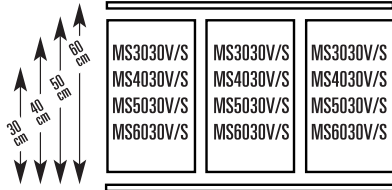

Disposición para traviesas de 100 cm

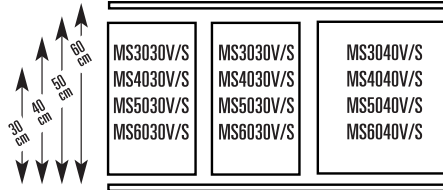

Disposición para traviesas de 110 cm

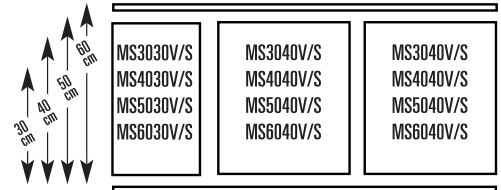

Disposición para traviesas de 120 cm

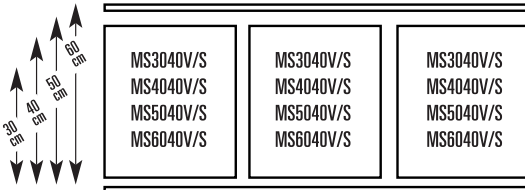

Disposición para traviesas de 130 cm

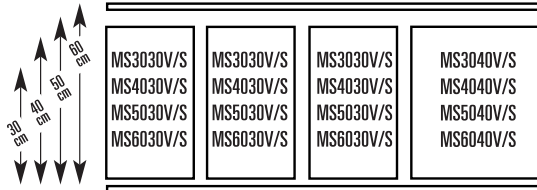

Disposición para traviesas de 140 cm

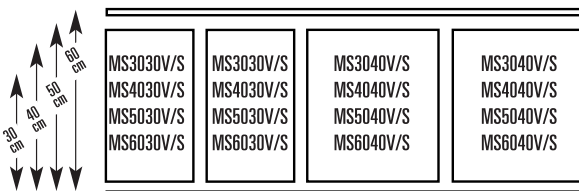

Disposición para traviesas de 150 cm

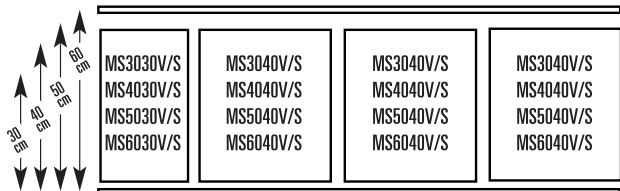

Disposición para traviesas de 160 cm

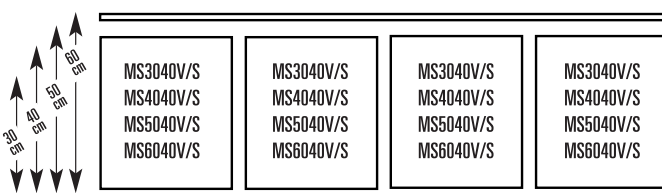

Disposición para traviesas de 170 cm

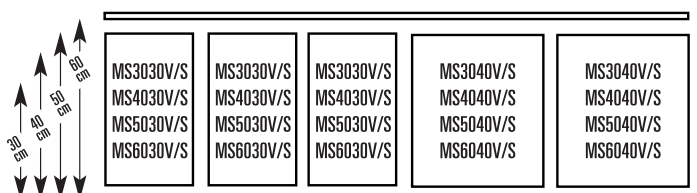

GARANTÍA VITALICIA LIMITADA

Cambro Manufacturing Company garantiza la ausencia de óxido y corrosión para traviesas Camshelving y postes estacionarios. Para unidades Camshelving móviles no se garantiza una ausencia de óxido o corrosión. Esta garantía cubre la duración o vida útil entera de Camshelving, siempre y cuando el producto haya sido sometido a un uso y mantenimiento normal y no haya sido modificado de alguna manera. Camshelving está previsto para el uso en la gastronomía y es compatible con productos y agentes limpiadores que son de uso habitual en ese ámbito. De esta garantía se excluye cualquier uso contrario a lo prescrito, abuso o fuerza mayor.

Cambro Manufacturing Company le cambiará el producto al comprador original contra presentación del correspondiente recibo de compra. En caso de una reclamación de garantía, póngase en contacto con el respectivo representante de Cambro o con el servicio de atención al cliente de Cambro, teléfono 0049 7024 9721 0 o a través de www.cambro.com.



GARANTÍA DEL FABRICANTE

Cambro le garantiza al comprador original que todas las piezas Camshelving™ están libres de defectos de fabricación y material. Esta garantía tiene una vigencia de hasta un año a partir de la fecha de envío desde el centro de distribución de Cambro, presuponiendo un uso y mantenimiento conforme a lo prescrito y que el producto no haya sido modificado de alguna manera.

En caso de que un producto no corresponda a esta garantía, el mismo podrá ser entregado a Cambro para una inspección. Las piezas que se encuentren como defectuosas serán reparadas o cambiadas.



Apropiado para productos alimenticios



No contiene cadmio



Polipropileno apropiado para reciclaje



LA DURABILIDAD HACE LA DIFERENCIA

CAMBRO®

MONTERINGSINSTRUKTION FÖR CAMSHELVING®



MONTERAD GRUNDSEKTION



MONTERAD GRUND- OCH PÅBYGGNADSEKTION.
MITTSTOLPEN BÄR BÅDA DELARNA.



MONTERAD GRUND- OCH
PÅBYGGNADSEKTION MED HÖRNBESLAG.

LÄS IGENOM ANVISNINGEN NOGGRANT FÖRE MONTERINGEN:

EN GUMMI- ELLER PLASTHAMMARE BEHÖVS FÖR EN KORREKT MONTERING – ANVÄND INTE METALLHAMMARE!

MONTERINGSTIPS

- Stolpbeslagens ovanliga konstruktion ger en utomordentlig tvärstabilitet som förstärks av att fästa det understa hyllplanet så lågt som möjligt till stolpen.
- Av säkerhetsskäl ska tyngre laster förvaras på de undre hyllplanen och lättare laster på de övre hyllplanen.
- Normala Camshelving-hyllor med fyra bärstolpar med tvärstag på 60 till 120 cm bär 200 kg per hyllplan och med tvärstag på 130 till 170 cm belastas med 150 kg per hyllplan.
- Hjulen till Camshelvings mobila hyllor klarar upp till 340 kg per sektion.
- Hyllplan som fästs med hörnbeslag har en största bärförmåga på 180 kg och bör användas med tvärstag på upp till 120 cm.
- Använd en gummi- eller plasthammare vid monteringen. När stolpbeslag och tvärstag slås på stolpar se till att beslagen ligger an mot stolparna. **SLÅ INTE FÖR HÅRT.**
- Hörnbeslagen bär normalt den kortare delen av tvärstagningen på hörnsektioner. Lägg tyngre laster på grundsektionen och lättare laster på sektionen som är monterad med hörnbeslag.

RENGÖRING

Camshelving-ytan är gjord av polypropen. Polypropen motstår fläckar och kemikalier och kan göras rent med de flesta vanliga rengöringsmedel. Camshelving-hyllplan kan tas ned och diskas placerade i en Camrack OETR314-brickdiskkorg med ena sidan öppen i en storköksdiskmaskin. Tvärstagen kan också tas ned och maskindiskas direkt på ett diskband. Stolparna och stolpbeslagen kan rengöras med ånga eller för hand med en trasa eller svamp med rengöringsmedel. Förbered en rengöringslösning enligt tillverkarens anvisning. Tvätta av ytan med en trasa eller svamp, skölj ordentligt och torka torrt. Om inga storköksdiskmaskiner finns tillgängliga så kan Camshelving-hyllplanen och tvärstagen rengöras på samma sätt.

A. FÖRBEREDELSE AV MONTERINGEN

1 Lägg fram och räkna alla delar.

a. Stolpsats: Innehåller 2 bärstolpar, 1 övre stolpbeslag och 1 undre stolpbeslag.



ÖVRE STOLPBESLAG

UNDRE STOLPBESLAG

MONTERAD
STOLPSATS

b. Hyllplansansatser: Innehåller 2 tvärstag och hyllplattor motsvarande tvärstagens längd

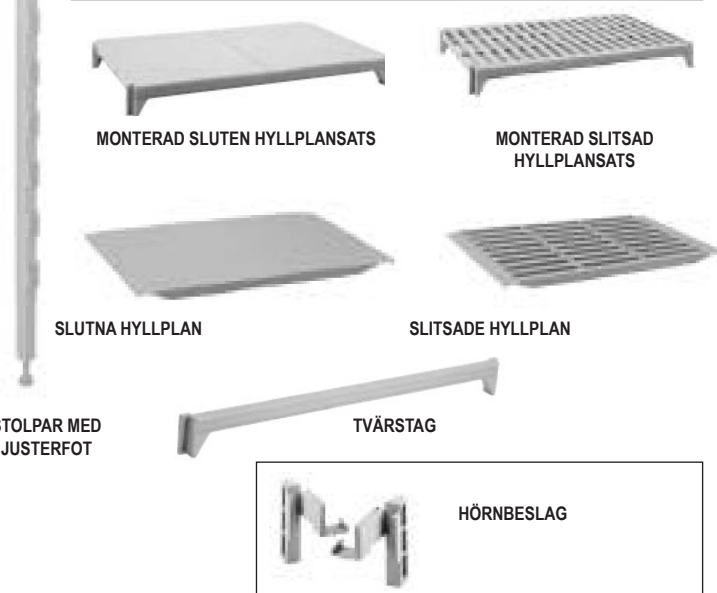

MONTERAD SLUTEN HYLLPLANSATS

MONTERAD SLITSAD
HYLLPLANSATS

SLUTNA HYLLPLAN

SLITSADE HYLLPLAN

STOLPAR MED
JUSTERFOT

TVÄRSTAG

HÖRNBESLAG

MONTERINGSINSTRUKTION FÖR CAMSHELVING®

LÄS IGENOM ANVISNINGEN NOGGRANT FÖRE MONTERINGEN.

EN GUMMI- ELLER PLASTHAMMARE BEHÖVS FÖR EN KORREKT MONTERING – ANVÄND INTE METALLHAMMARE!

B. MONTERING AV EN GRUNDSEKTION

1 Montering av stolpsats

- Ställ två stolpar med laxstjärt mot varandra.
- Fäst det undre stolpbeslaget med en gummi- eller plasthammare till de andra två stolparna enligt pilriktingen. Slå omväxlande på bägge sidorna tills förbindelsebeslaget sitter ordentligt fast.
- Fäst det övre stolpbeslaget till övre änden av de båda stolparna. Slå omväxlande på bägge sidorna tills förbindelsebeslaget sitter ordentligt fast.
- Gör likadant med den andra stolpramen.

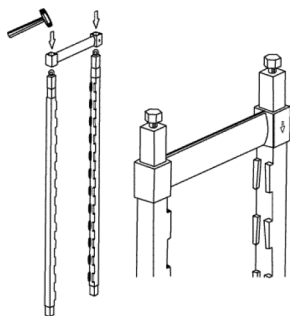

MONTERING AV DET UNDERE STOLPBESLAGET

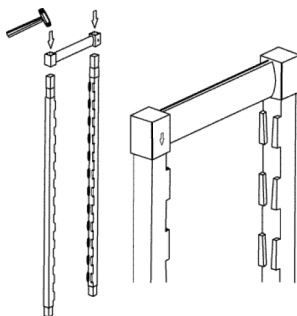

MONTERING AV DET ÖVRE STOLPBESLAGET



MONTERAD STOLPE MED STOLPBESLAG

2 Montera tvärstagen

- Fastställ uppställningsplats för hyllan.
- Montera tvärstagen till stolparna:
 - Justera den undre delen av laxstjärtöppningen till stolpens undre del av laxstjärten.
 - Tryck tvärstaget till stolparna.
 - Sänk ned tvärstaget.
 - Slå fast tvärstagets båda ändar med en gummi- eller plasthammare.
- Montera tvärstaget till stolpramen på motsatt sida.

3 Se till att sektionen står vågrätt. Justera vid behov justerfoten med en nyckel (15/16").

4 Lägg hyllplanen på tvärstagen.

Se "Arrangemang av hyllplansatser" på denna instruktions baksida.

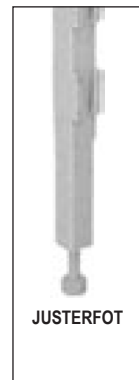

JUSTERFOT

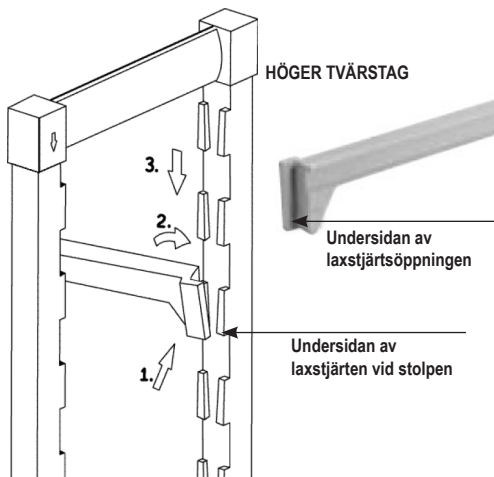

MONTERING AV TVÄRSTAG TILL STOLPARNA

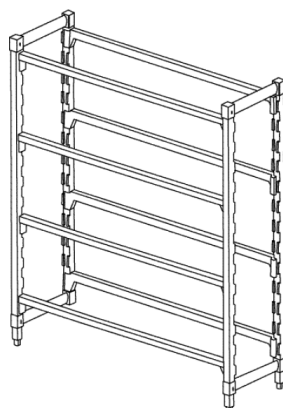

MONTERADE TVÄRSTAG, KOMPLETT



UPPLÄGGNING AV HYLLPLAN PÅ TVÄRSTAGEN

MONTERINGSINSTRUKTION FÖR CAMSHELVING®

LÄS IGENOM ANVISNINGEN NOGGRANT FÖRE MONTERINGEN:

EN GUMMI- ELLER PLASTHAMMARE BEHÖVS FÖR EN KORREKT MONTERING – ANVÄND INTE METALLHAMMARE!

C. PÅBYGGNAD AV EN SEKTION I RAD

- 1 Montera den första sektionen som beskrivits i steg (B).
- 2 Montera en andra stolpram som beskrivits i steg (B1).
- 3 Montera ett tvärstag mellan den första sektionens stolpe och den andra stolpramen. Den första och andra sektionens tvärstag bärs upp av samma mittstolpe.
- 4 Se till att sektionen står vågrätt. Justera vid behov justerfoten med en nyckel (15/16").
- 5 Lägg hyllplanen på tvärstagen.

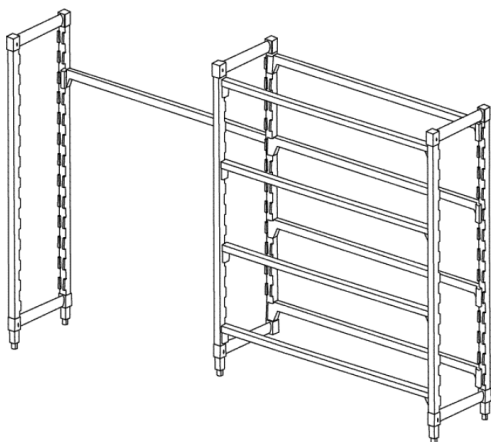

MONTERING AV PÅBYGGNADSENHETEN



MONTERAD GRUND- OCH PÅBYGGNADSEKTION:
MITTSTOLPEN BÄR BÅDA DELARNA.

D. PÅBYGGNAD AV EN SEKTION I 90°-VINKEL

- 1 Montera den första sektionen som beskrivits i steg (B).
- 2 Montera en andra stolpram som beskrivits i steg (B1).
- 3 Lokalisera och montera de högra och vänstra hörnbeslagen till den första sektionens tvärstag. *Montera hörnbeslagen:*
 - a. Sätt in hörnbeslagets överkant i spåret på tvärstagets överkant.
 - b. Tryck fast hörnbeslaget till tvärstagets kanter.
 - c. Skjut hörnbeslaget till rätt plats på tvärstaget så att det motsvarar den andra sektionens bredd.
- 4 Montera ett höger och ett vänster hörnbeslag på samtliga hyllplan i den första sektionen.
- 5 Montera tvärstag mellan hörnbeslagen och den andra stolpramen.
 - a. Lås fast tvärstagen (på samma sätt som med laxstjärtarna på stolparna) på hörnbeslagens laxstjärt.
- 6 Se till att sektionen står vågrätt. Justera vid behov justerfoten med en nyckel (15/16").
- 7 Lägg hyllplanen på tvärstagen.



HÖRNBSLAG

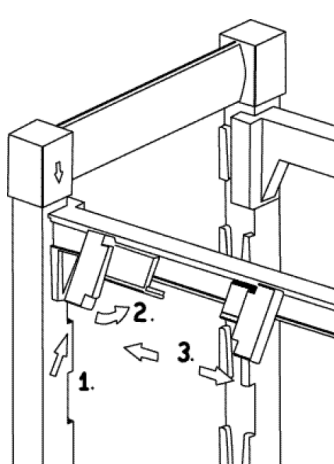

TVÄRSTAGETS
SNÄPPLÅS

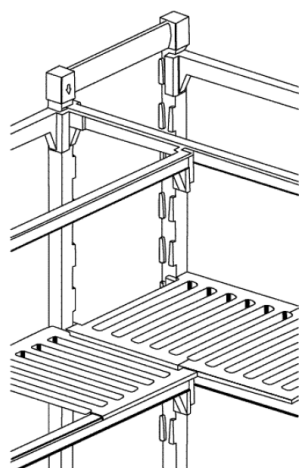

TVÄRSTAGENS MONTERING



CAMBRO HÖRNBSLAG –

Användbara tips

- Hyllor som är hopsatta med hörnbeslag har en största bärförmåga på 180 kg.
- Tvärstag fastsatta med Cambro hörnbeslag bör vara längst 120 cm långa.
- Vid montering av tvärstag av olika längd: Montera först hörnbeslagen till de längre tvärstagen och därefter de kortare tvärstagen till hörnbeslagen.

ARRANGEMANG AV CAMSHELVING®-HYLLPLANSATSER

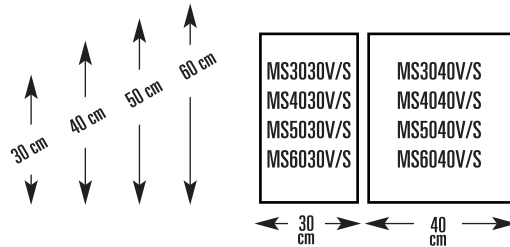

S resp. V betyder slutna resp. slitsade hyllplansatser

Arrangemang för 60 cm-tvärstag

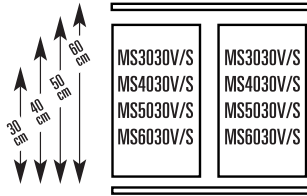

Arrangemang för 70 cm-tvärstag

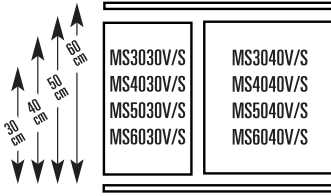

Arrangemang för 80 cm-tvärstag

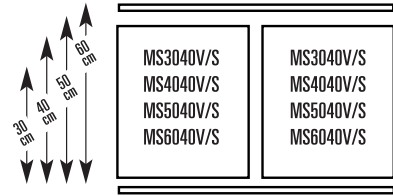

Arrangemang för 90 cm-tvärstag

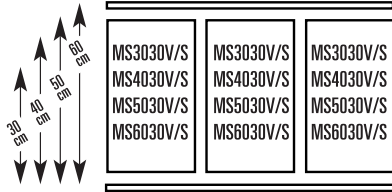

Arrangemang för 100 cm-tvärstag

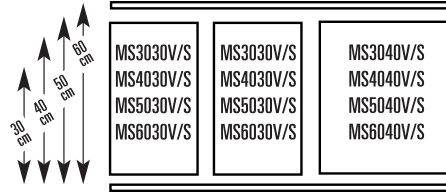

Arrangemang för 110 cm-tvärstag

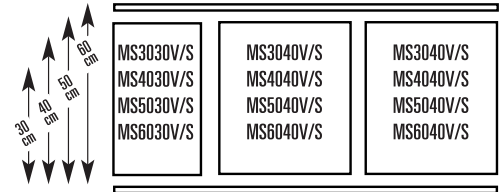

Arrangemang för 120 cm-tvärstag

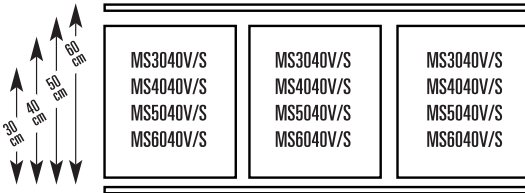

Arrangemang för 130 cm-tvärstag

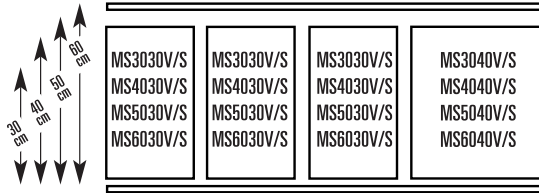

Arrangemang för 140 cm-tvärstag

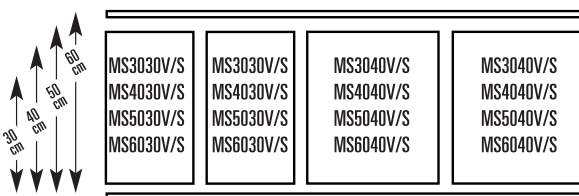

Arrangemang för 150 cm-tvärstag

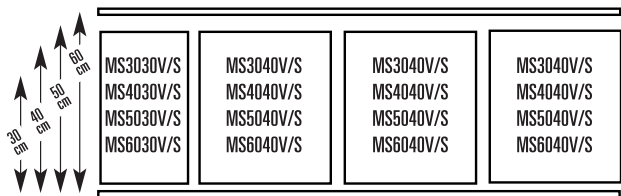

Arrangemang för 160 cm-tvärstag

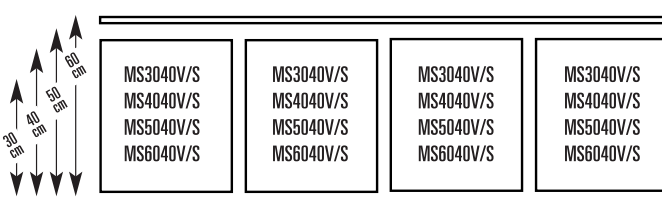

Arrangemang för 170 cm-tvärstag

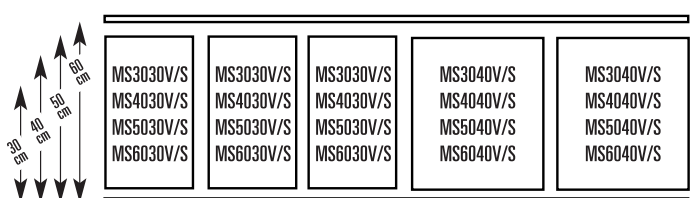

LIVSLÅNG BEGRÄNSAD GARANTI

Cambro Manufacturing Company garanterar att Camshelving-tvärstag och stationära stolpar inte rostar eller korroderar. För mobila Camshelving-sektioner ges inte någon garanti att de inte rostar resp. korroderar. Denna garanti gäller för Camshelving-produktens hela livslängd under förutsättning att produkten använts och skötts normalt och inte ändrats på något vis. Camshelving är avsedd för användning inom storkök och är förenlig med rengöringsmedel som används inom denna bransch. Garantin täcker inte annan användning, misskötsel eller force majeure.

Cambro Manufacturing Company byter ut produkten med den ursprungliga kunden och uppvisande av köpkvitto. Ställ garantikraven till lämplig Cambro-representant eller till Cambros kundtjänst, på telefon +49 7024 9721 0 eller ta kontakt via www.cambro.com.

TILLVERKARGARANTI

Cambro garanterar den ursprungliga kunden att alla Camshelving™-delar saknar tillverknings- och materialfel. Denna garanti gäller upp till ett år efter utleverans från Cambros distributionslager och vid normal och lämplig användning och skötsel samt under förutsättning att produkten inte ändrats på något vis. Om en produkt inte motsvarar denna garanti kan den lämnas till Cambro för besiktning. Delar som visar sig vara defekta repareras eller byts ut.



Lämpligt för livsmedel



Fritt från kadmium



Polypropren är lämplig för återvinning



CAMBRO®

MONTAGEHANDLEIDING VOOR CAMSHELIVING®



GEMONTEERDE ENKELE UNIT



GEMONTEERDE ENKELE UNIT MET AANBOUWUNIT.
MIDDENSTIJL DRAAGT BEIDE UNITS.



GEMONTEERDE ENKELE UNIT EN AANBOUW-
UNIT MET HOEKVERBINDINGEN.

DE INSTRUCTIES VOOR DE MONTAGE AANDACHTIG DOORLEZEN:

VOOR EEN MONTAGE CONFORM DE VOORSCHRIFTEN IS EEN RUBBEREN OF KUNSTSTOFHAMER NODIG - GEEN METALEN HAMER GEBRUIKEN

MONTAGETIPS

- De onconventionele constructie van de stijlverbindingen zorgt voor een buitengewone dwarsstabiliteit die nog wordt versterkt wanneer het onderste vak zo laag mogelijk op de stijl wordt aangebracht.
- Omwille van de veiligheid moeten zware lasten in de onderste vakken en lichtere lasten in de bovenste vakken worden bewaard.
- Normale Camshelving-rekken met vier draagstijlen kunnen bij gebruik van een 60 tot 120 cm lange dwarsligger 200 kg per vak dragen en bij gebruik van een 130 tot 170 cm lange dwarsligger 150 kg per vak.
- De wieltjes voor mobiele Camshelving-units kunnen tot 340 kg per unit dragen.
- Schappen die met hoekverbindingen zijn bevestigd hebben een max. draagvermogen van 180 kg en moeten worden gebruikt met dwarsliggers van max. 120 cm.
- Bij de montage een rubberen of kunststofhamer gebruiken. Bij het aanhameren van de stijlverbindingen en de dwarsliggers op de stijlen erop letten dat de verbindingstukken vlak tegen de stijlen aanliggen. NIET TE HARD HAMEREN.
- Bij hoekunits draagt de hoekverbinding normaal de korte kant van de dwarsligger. Zwaardere lasten op de hoofdunit leggen, lichtere lasten op de met hoekverbindingen aangemonteerde unit leggen.

REINIGINGSINSTRUCTIES

Het Camshelving-oppervlak is van polypropyleen. Polypropyleen is vlek- en chemicaliënbestendig en kan met de meeste gangbare reinigingsmiddelen worden gereinigd.

De Camshelving-schappen kunnen worden verwijderd en in een aan één zijde open Camrack OETR314-tabletspoelkorf worden afgespoeld in een industriële vaatwasmachine. Dwarsliggers kunnen eveneens worden verwijderd en direct machinaal worden afgespoeld op een vaatspoelband. De stijlen en stijlverbindingen kunnen met stoom of manueel met een doek of spons en reinigingsmiddel worden gereinigd. Maak hiervoor een reinigungsoplossing klaar overeenkomstig de handleiding van de fabrikant. De oppervlakken met een doek of spons afwassen, grondig afspoelen en droog wrijven. Indien er geen industriële vaatwasmachine voorhanden is, kunnen de Camshelving-schappen en de dwarsliggers op dezelfde manier worden gereinigd.

A. VOORBEREIDING VOOR DE MONTAGE

1 Eerst alle onderdelen klaarleggen en tellen.

a. Stijlbouwpakket: bevat 2 draagstijlen, 1 bovenste stijlverbinding en 1 onderste stijlverbinding.



b. Bouwpakketten: bevatten 2 dwarsliggers en schappen voor de lengte van de dwarsliggers



MONTAGEHANDLEIDING VOOR CAMSHELVI[®]

DE INSTRUCTIES VOOR DE MONTAGE AANDACHTIG DOORLEZEN.

VOOR EEN MONTAGE CONFORM DE VOORSCHRIFTEN IS EEN RUBBEREN OF KUNSTSTOFHAMER NODIG - GEEN METALEN HAMER GEBRUIKEN!

B. MONTAGE VAN EEN ENKELE UNIT

1 Montage van de stijlbouwpakketten

- Twee stijlen met de zwaluwstaarten tegenover elkaar vasthouden.
- De onderste stijlverbinding overeenkomstig de richting van de pijl met een rubberen of kunststofhamer op beide stijlen bevestigen.
Afwisselend op beide zijden hameren tot het verbindingsstuk goed vastzit.
- De bovenste stijlverbinding op het bovenste uiteinde van beide stijlen bevestigen.
Afwisselend op beide zijden hameren tot het verbindingsstuk goed vastzit.
- Op dezelfde manier te werk gaan met het tweede stijlframe.

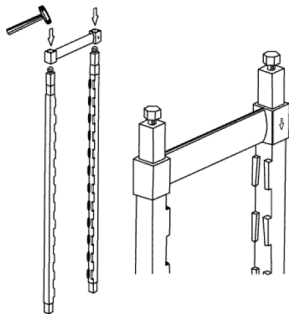

AANBRENGEN VAN DE ONDERSTE
STIJLVERBINDING

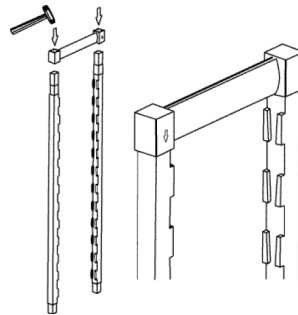

AANBRENGEN VAN DE BOVENSTE
STIJLVERBINDING



GEMONTEERDE STIJL MET
STIJLVERBINDINGEN

2 De dwarsliggers aanbrengen

- De opstellingsplaats voor het rek bepalen.
- De dwarsliggers op de stijlen bevestigen:
 - Het onderste deel van de zwaluwstaartopening uitrichten met het onderste deel van de zwaluwstaart.
 - De dwarsligger tegen de stijl aandrukken.
 - De dwarsligger laten zakken.
 - Beide uiteinden van de dwarsligger met een rubberen of kunststofhamer vastkloppen.
- De dwarsligger aan de tegenoverliggende kant van het stijlframe bevestigen.



3 Ervoor zorgen dat de unit horizontaal staat. Indien nodig de afstelvoet met een moersleutel (15/16") overeenkomstig bijregelen.

4 De schappen op de dwarsliggers leggen.

Zie hiervoor 'Indeling van de schappakketten' op de achterkant van deze handleiding.

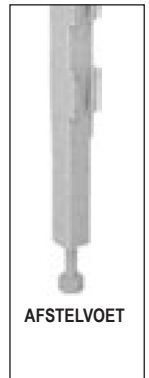

AFSTELVOET

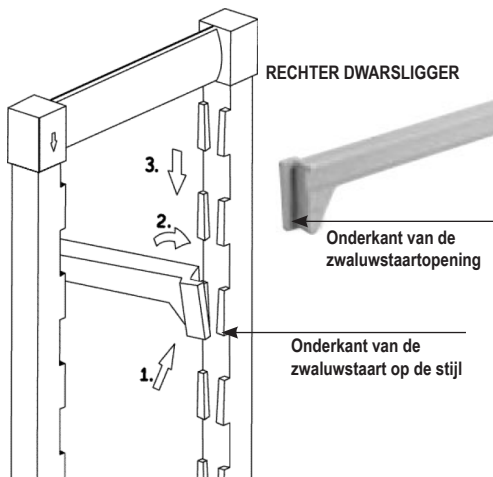

RECHTER DWARSLIGGER

Onderkant van de
zwaluwstaartopening

Onderkant van de
zwaluwstaart op de stijl

BEVESTIGING VAN DE DWARSLIGGER OP
DE STIJL

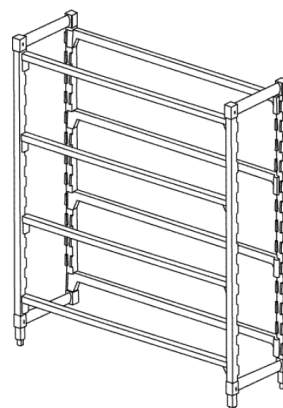

GEMONTEERDE DWARSLIGGERS, COMPLEET



PLAATSING VAN DE SCHAPPEN
OP DE DWARSLIGGERS

MONTAGEHANDLEIDING VOOR CAMSHELING®

DE INSTRUCTIES VOOR DE MONTAGE AANDACHTIG DOORLEZEN:

VOOR EEN MONTAGE CONFORM DE VOORSCHRIFTEN IS EEN RUBBEREN OF KUNSTSTOFHAMER NODIG - GEEN METALEN HAMER GEBRUIKEN!

C. AANBOUW VAN EEN UNIT IN EEN RECHTE RIJ

- 1 De eerste unit zoals beschreven in stap (B) assembleren.
- 2 Een tweede stijlframe zoals beschreven in stap (B1) assembleren.
- 3 Een dwarsligger bevestigen tussen de stijlen van de eerste unit en het tweede stijlframe.
De dwarsliggers van de eerste en de tweede unit worden door dezelfde middenstijl gedragen.
- 4 Ervoor zorgen dat de unit horizontaal staat. Indien nodig de afstelvoet met een moersleutel (15/16") bijregelen.
- 5 De schappen op de dwarsliggers leggen.

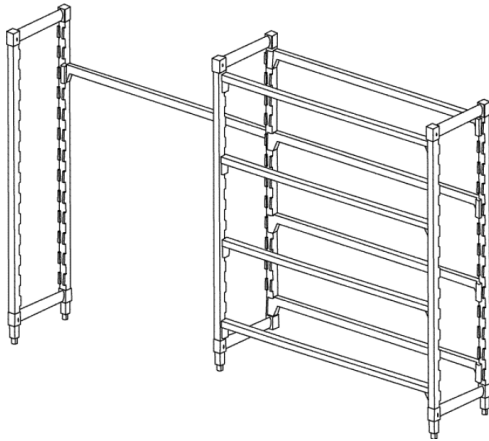

AANBRENGEN VAN DE AANBOUWUNIT



GEMONTEERDE ENKELE UNIT MET AANBOUWUNIT:
MIDDENSTIJL DRAAGT BEIDE UNITS.

D. AANBOUW VAN EEN UNIT IN EEN HOEK VAN 90°

- 1 De eerste unit zoals beschreven in stap (B) assembleren.
- 2 Een tweede stijlframe zoals beschreven in stap (B1) assembleren.
- 3 De rechter en linker hoekverbindingen bepalen en aan de dwarsliggers van de eerste unit bevestigen. *Aanbrengen van de hoekverbindingen:*
 - a. De bovenkant van de hoekverbinding in de groef op de bovenkant van de dwarsligger plaatsen.
 - b. De hoekverbinding vast aandrukken tegen de zijkant van de dwarsligger.
 - c. De hoekverbinding naar de correcte plaats op de dwarsligger schuiven, zodat dit met de breedte van de tweede unit overeenkomt.
- 4 Op elk schap van de eerste unit eveneens een rechter en linker hoekverbinding aanbrengen.
- 5 De dwarsliggers bevestigen tussen de hoekverbindingen en het tweede stijlframe.
 - a. De dwarsliggers klikken vast in de zwaluwstaarten van de hoekverbindingen (net als op de zwaluwstaarten van de stijlen).
- 6 Ervoor zorgen dat de unit horizontaal staat. Indien nodig de afstelvoet met een moersleutel (15/16") bijregelen.
- 7 De schappen op de dwarsliggers leggen.



HOEKVERBINDINGEN

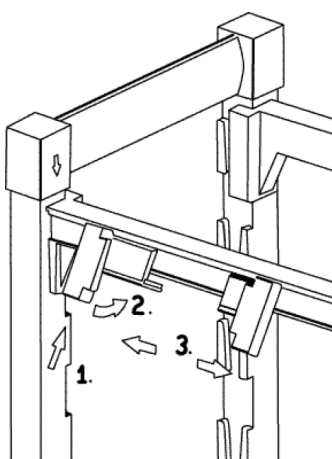

KLAPVERBINDINGEN
VAN DE DWARSLIGGERS

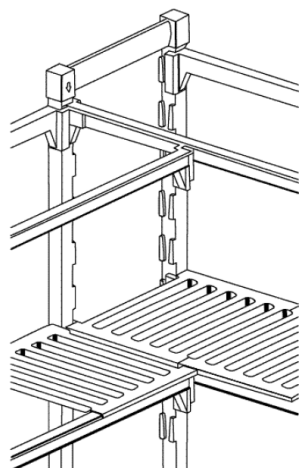

BEVESTIGING VAN DE DWARSLIGGERS



CAMBRO-hoekverbindingen -

Nuttige tips

- Rekken die met hoekstukken zijn verbonden hebben een max. draagvermogen van 180 kg.
- Met Camshelving®-hoekverbindingen verbonden dwarsliggers mogen niet langer zijn dan 120 cm.
- Bij de verbinding van dwarsliggers van ongelijke lengte, de hoekverbindingen eerst op de langere dwarsliggers bevestigen en daarna de kortere dwarsliggers op de hoekverbindingen bevestigen.

INDELING VAN DE CAMSHELING®-SCHAPPAKKETTEN

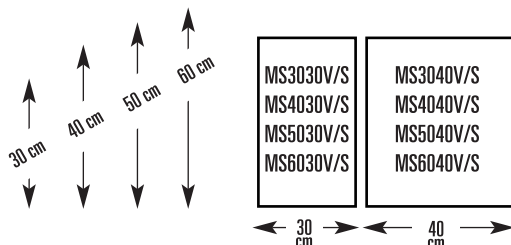

S, resp. V betekenen gesloten, resp. gesleufde schappakketten

Indeling voor dwarsliggers van 60 cm

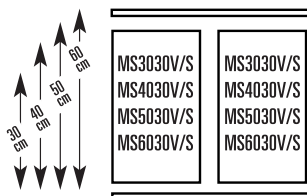

Indeling voor dwarsliggers van 70 cm

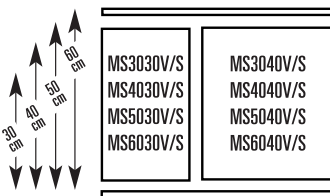

Indeling voor dwarsliggers van 80 cm



Indeling voor dwarsliggers van 90 cm

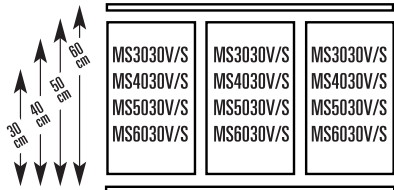

Indeling voor dwarsliggers van 100 cm

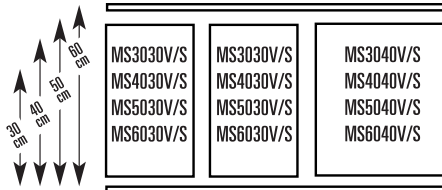

Indeling voor dwarsliggers van 110 cm

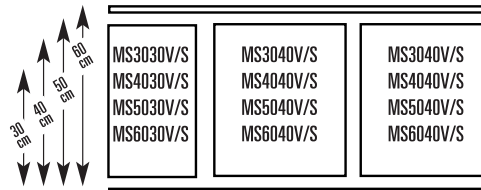

Indeling voor dwarsliggers van 120 cm

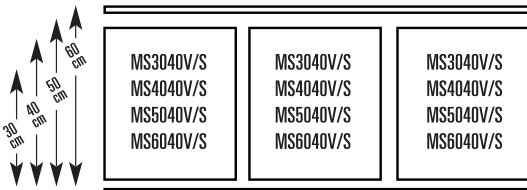

Indeling voor dwarsliggers van 130 cm

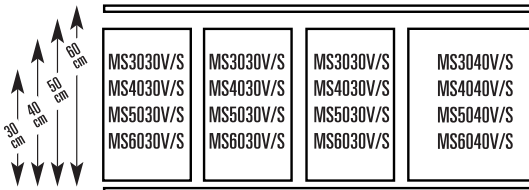

Indeling voor dwarsliggers van 140 cm

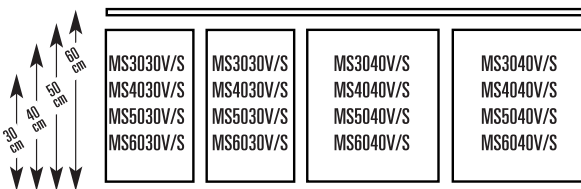

Indeling voor dwarsliggers van 150 cm



Indeling voor dwarsliggers van 160 cm

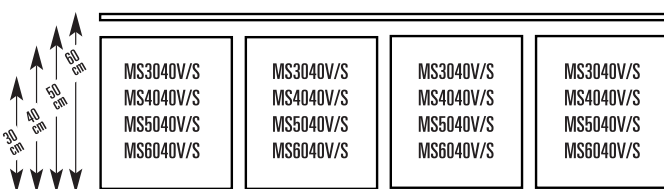

Indeling voor dwarsliggers van 170 cm

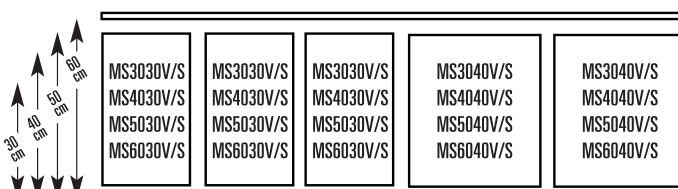

LEVENSLANGE BEPERKTE GARANTIE

De Cambro Manufacturing Company garandeert de vrijheid van roest en corrosie voor Camshelving-dwarsliggers en stationaire stijlen. Voor mobiele Camshelving-units wordt geen garantie inzake vrijheid van roest en corrosie verleend. Deze garantie is geldig voor de levensduur van het Camshelving-systeem, onder voorbehoud van het feit dat het product normaal werd gebruikt en onderhouden, en op generlei wijze werd gewijzigd. Camshelving is voorzien voor gebruik in de gastronomie en is compatibel met producten en reinigingsmiddelen die in dit vakgebied gangbaar zijn. Gebruik voor andere doeleinden, misbruik en overmacht zijn uitgesloten van de garantie.

De Cambro Manufacturing Company vervangt het product voor de originele koper mits voorlegging van de aankoopfactuur. Neem bij garantiereclams contact op met de bevoegde Cambro-dealer of de Cambro-klantendienst, op het telefoonnummer 0049 7024 9721 0, of via www.cambro.com.

FABRIEKSGARANTIE

Cambro garandeert de originele koper dat alle Camshelving™-onderdelen vrij zijn van fabricagefouten en materiaalgebreken. Deze garantie is 1 jaar geldig vanaf de verzendingsdatum vanuit het Cambro-magazijn en dit bij normaal, doelmatig gebruik en onderhoud, onder voorbehoud van het feit dat het product op generlei wijze werd gewijzigd. Indien een product niet beantwoordt aan deze garantie kan het naar Cambro worden verstuurd voor een inspectie. Onderdelen die als defect worden beoordeeld, worden hersteld of vervangen.



Geschikt voor voedingsmiddelen



Zonder cadmium



Voor recycling geschikt polypropyleen



CAMBRO®

MONTERINGSANVISNING FOR CAMSHELIVING®



MONTERT ENKELTENHET



MONTERT ENKELT- OG PÅMONTERINGSENHET.
MIDTSTOLPEN BÆRER BEGGE ENHETER.



MONTERT ENKELT- OG PÅMONTERINGSENHET
MED HJØRNEFORBINDELSER.

LES OPPMERKSOMT GJENNOM ANVISNINGENE FØR MONTERING:

FOR FORSKRIFTMESSIG MONTERING ER DET NØDVENDIG MED EN GUMMI- ELLER PLASTHAMMER - DET MÅ IKKE BRUKES METALLHAMMER

MONTERINGSTIPS

- Den ukonvensjonelle konstruksjonsmetoden på stolpeforbindelsene sørger for en uvanlig tverrstabilitet, som dessuten kan forsterkes ved å anbringe den nederste hyllene så lavt som mulig på stolpen.
- Av sikkerhetsmessige grunner skal de tyngre gjenstandene legges på de nederste hyllene og de lettere gjenstandene oppbevares i de øvre hyllene.
- Normale Camshelving-hyller med fire bærestolper holder ved bruk av en 60 til 120 cm tverrstang 200 kg pr. hylle, og ved bruk av en tverrstang på 130 til 170 cm holder de 150 kg pr. hylle.
- Rullene for Camshelving mobilenheter holder opptil 340 kg pr. enhet.
- Hylleplater som er festet med hjørneforbindelser har en maks. bærekapasitet på 180 kg og skal brukes med tverrstenger på opptil 120 cm.
- Ved monteringen skal det brukes en gummi- eller plasthammer. Ved hamring av stolpeforbindelsene og tverrstengene til stolpene må det påses av forbindelsesstykkene ligger i flukt med stolpene. **IKKE HAMRE FOR HARDT.**
- Ved hjørneenheter bærer hjørneforbindelsen normalt sett den kortere delen av tverrstøtten. Legg tyngre gjenstander på hovedenheten, lettere gjenstander på enheten som er montert på med hjørneforbindelser.

RENGJØRINGSANVISNINGER

Camshelving-overflaten er produsert i polypropylen. Polypropylen er flekk- og kjemikaliefast, og kan rengjøres med de fleste vanlige rengjøringsmidler.

Camshelving hylleplater kan tas av og vaskes i en Camrack OETR314-brettvasketurv i henhold til rengjøringsanvisningene i en kommersiell oppvaskmaskin. Tverrbjelker kan også tas av og skylles direkte på et oppvaskbånd maskinelt. Stolper og stolpeforbindelser kan rengjøres med damp eller forhånd med en klut eller en svamp og rengjøringsmiddel. Forbered en rengjøringsløsning i henhold til produsentens veiledning. Vask av overflaten med en klut eller en svamp, skyll grundig og tørk av. Hvis det ikke finnes noen kommersiell oppvaskmaskin, kan Camshelving hylleplater og tverrstenger rengjøres på samme måte.

A. KLARGJØRING FOR MONTERING

1 Legg først klar alle deler og tell dem.

a. Stolpebyggesett: Inneholder 2 bærestolper, 1 øvre stolpeforbindelse og 1 nedre stolpeforbindelse.

ØVRE STOLPEFORBINDELSE



NEDRE STOLPEFORBINDELSE



MONTERT
STOLPEBYGGESETT

b. Hyllebyggesett: Inneholder 2 tverrstenger og hylleplater for lengden til tverrstengene



MONTERT LUKKET HYLLEBYGGESETT

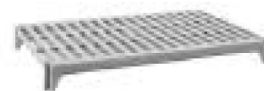

MONTERT SLISSET
HYLLEBYGGESETT

LUKKEDE HYLLEPLATER



SLISSEDE HYLLEPLATER

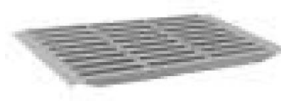

STOLPLER MED
JUSTERBAR FOT



TVERRSTANG



HJØRNEFORBINDELSER

MONTERINGSANVISNING FOR CAMSHELVING®

LES OPPMERKSOMT GJENNOM ANVISNINGENE FØR MONTERING.

FOR FORSKRIFTMESSIG MONTERING ER DET NØDVENDIG MED EN GUMMI- ELLER PLASTHAMMER - DET MÅ IKKE BRUKES METALLHAMMER!

B. MONTERING AV EN ENKELTENHET

1 Montering av stolpebyggesett

- Hold to stolper med svalehaler overfor hverandre.
- Fest den nederste stolpeforbindelsen på begge stolpene i henhold til pilretningene med en gummi- eller plasthammer.
- Fest den øvre stolpeforbindelsen på den øvre enden av begge stolper.
- Gå frem på samme måte med den andre stolperammen.

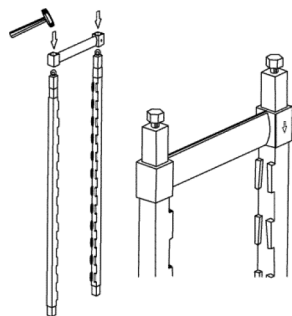

PÅSETTING AV NEDRE
STOLPEFORBINDELSE

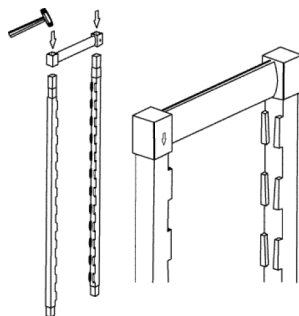

PÅSETTING AV ØVRE
STOLPEFORBINDELSE



MONTERTE STOLPER MED
STOLPEFORBINDELSER

2 Monter tverrstengene

- Bestem oppstillingsplassen for hyllen.
- Fest tverrstengene på stolpene:
 - Innrett den nedre delen av svalehaleåpningen på den nedre delen av svalehalen på stolpen.
 - Trykk tverrstangen på stolpen.
 - Senk tverrstangen ned.
 - Bank fast begge ender av tverrstangen med en gummi- eller plasthammer.
- Fest tverrstangen på motliggende side av stolperammen.



3 Forsikre deg om at enheten står vannrett. Ved behov etterstiller du justeringsfoten med en skrutrekker (15/16") tilsvarende.

4 Legg hylleplatene på tverrstengene.

Se "Innordning av hylleoppleggssettene" på baksiden av denne anvisningen.

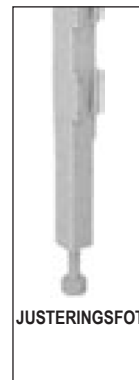

JUSTERINGSFOT

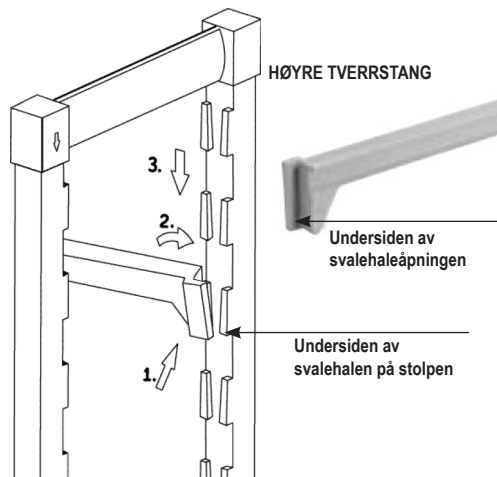

FESTE AV TVERRSTANG TIL STOLPEN

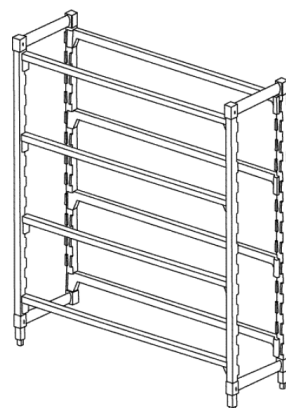

MONTERTE TVERRSTENGER, KOMPLETT



OPPLEGG AV HYLLEPLATER
PÅ TVERRSTENGENE

MONTERINGSANVISNING FOR CAMSHELVING®

LES OPPMERKSOMT GJENNOM ANVISNINGENE FØR MONTERING:

FOR FORSKRIFTMESSIG MONTERING ER DET NØDVENDIG MED EN GUMMI- ELLER PLASTHAMMER - DET MÅ IKKE BRUKES METALLHAMMER!

C. PÅMONTERING AV EN ENHET I RAD

- 1 Den første enheten monteres som beskrevet i trinn (B).
- 2 Monter den andre enheten som beskrevet i trinn (B1).
- 3 Fest en tverrstang mellom stolpen i den første enheten og den andre stolperammen. Tverrstengene i første og andre enhet bæres av den samme midtstolpen.
- 4 Forsikre deg om at enheten står vannrett. Ved behov etterstiller du justeringsfoten med en skrutrekker (15/16").
- 5 Legg hylleplatene på tverrstengene.

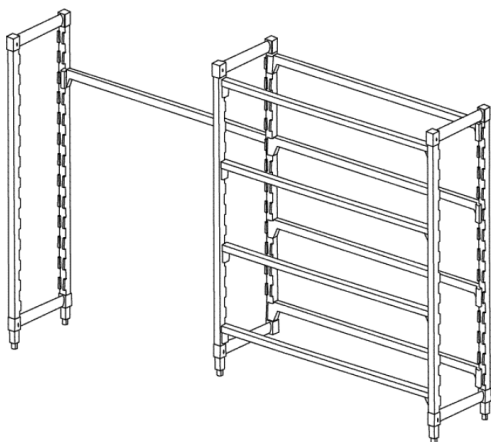

PÅSETTING AV PÅBYGGINGSENHETEN



MONTERT ENKELT- OG PÅMONTERINGSENHET:
MIDTSTOLPEN BÆRER BEGGE ENHETER.

D. PÅMONTERING AV EN ENHET I 90° VINKEL

- 1 Den første enheten monteres som beskrevet i trinn (B).
- 2 Monter den andre enheten som beskrevet i trinn (B1).
- 3 Undersøk de høyre og venstre hjørneforbindelsene og fest på tverrstolpene til den første enheten. *Påmontering av hjørneforbindelsene:*
 - a. Sett overkanten på hjørneforbindelsene inn i sporet på overkanten av tverrstangen.
 - b. Trykk fast hjørneforbindelsen til kantene på tverrstangen.
 - c. Skyv hjørneforbindelsen til riktig sted på tverrstangen, slik at det tilsvarer bredden til den andre enheten.
- 4 Fest likedan en høyre og venstre tverrforbindelse på hver hylle i den første enheten.
- 5 Fest tverrstangen mellom hjørneforbindelsene og den andre stolperammen.
 - a. Tverrstengene låses inn (som på svalehalen til stolpen) på svalehalen til hjørneforbindelsene.
- 6 Forsikre deg om at enheten står vannrett. Ved behov etterstiller du justeringsfoten med en skrutrekker (15/16").
- 7 Legg hylleplatene på tverrstengene.



HJØRNEFORBINDELSER

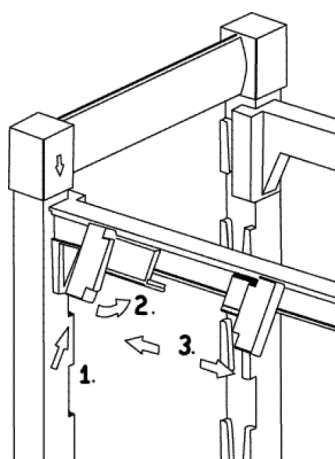

HURTIGFORBINDELSER PÅ TVERRSTANG

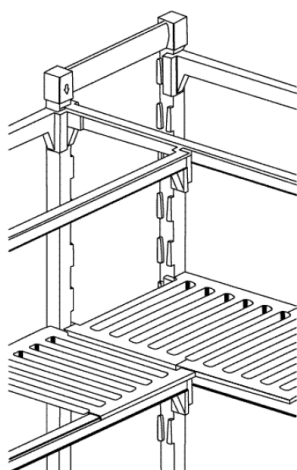

FESTE AV TVERRSTENGENE



CAMBRO hjørneforbindelser -

nyttige tips

- Hyller som er forbundet med hjørnestykker har en maks. bærekapasitet på 180 kg.
- Tverrstenger som er forbundet med Camshelving® hjørneforbindelser skal kun være opptil 120 cm i lengden.
- Ved forbindelser av tverrstenger i ulike lengder festes hjørneforbindelsene først på de lengre tverrstengene, og deretter festes de kortere tverrstengene til hjørneforbindelsene.

INNORDNING AV CAMSHELVING® HYLLEOPPLEGGSSETT

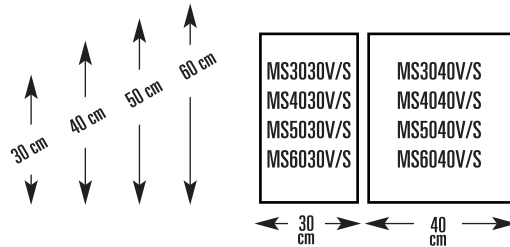

S hhv. V betyr lukket hhv. slisset hylleoppleggsett

Innordning for 60 cm tverrstenger

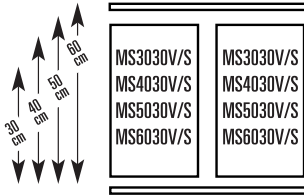

Innordning for 70 cm tverrstenger

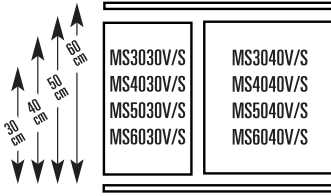

Innordning for 80 cm tverrstenger

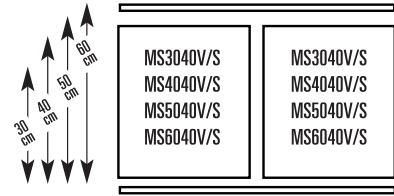

Innordning for 90 cm tverrstenger

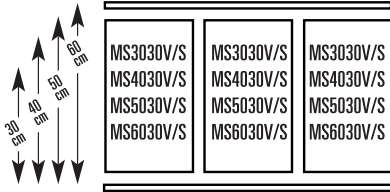

Innordning for 100 cm tverrstenger

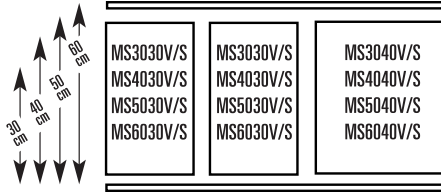

Innordning for 110 cm tverrstenger

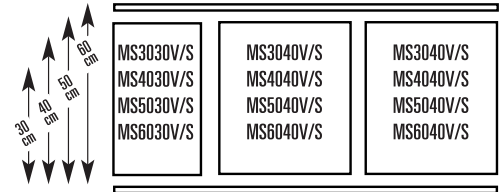

Innordning for 120 cm tverrstenger

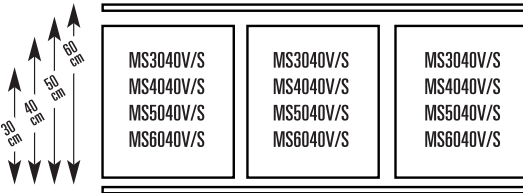

Innordning for 130 cm tverrstenger

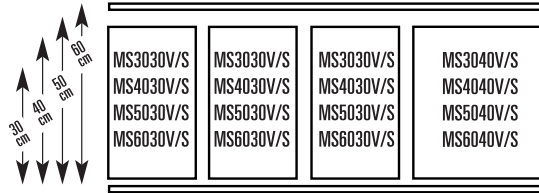

Innordning for 140 cm tverrstenger

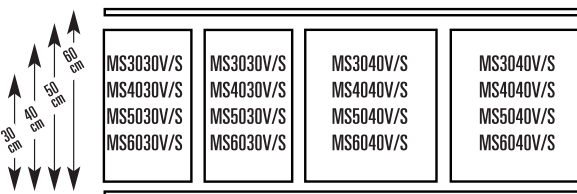

Innordning for 150 cm tverrstenger



Innordning for 160 cm tverrstenger

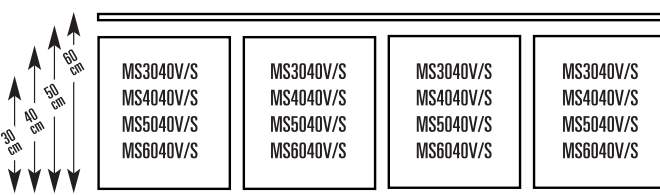

Innordning for 170 cm tverrstenger

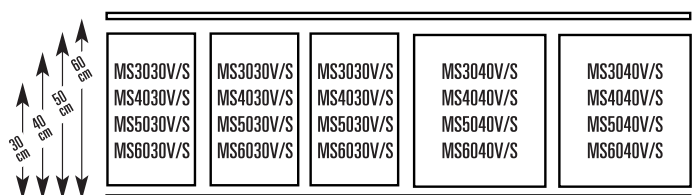

LIVSLANG BEGRENSET GARANTI

Cambro Manufacturing Company garanterer rust- og korrosjonsfrihet for Camshelving tverrstenger og stasjonære stolper. For mobile Camshelving-enheter garanteres ingen rust- hhv. korrosjonsfrihet. Denne garantien gjelder for levetiden til Camshelving, forutsatt at produktet brukes og vedlikeholdes som normalt og ikke modifiseres på noen måte. Camshelving er foresatt til bruk innen gastronomi og er kompatibel med produkter og rengjøringsmidler som er vanlige på dette området. Bruk til andre formål, misbruk og bruk av makt er utelukket fra garantien.

Cambro Manufacturing Company erstatter produktet for den opprinnelige kjøperen mot fremleggning av kjøpekvittering. Ved garantikrav ta kontakt med den ansvarlige Cambro-representanten eller Cambros kundeservice på telefon 0049 7024 9721 0 eller via

www.cambro.com.



PRODUSENTGARANTI

Cambro garanterer overfor den opprinnelige kjøperen at alle Camshelving™-deler er fri for feil i utførelse og materiale. Denne garantien gjelder i opptil ett år etter forsendelse fra Cambros salgssenter ved normal, formålsmessig bruk og vedlikehold, forutsatt at produktet ikke modifiseres på noen måte.

Hvis et produkt ikke overholder denne garantien, kan det overlates til Cambro for inspeksjon. Deler som er defekte, blir reparert eller skiftet ut.



Egnet for næringsmidler



Uten kadmium



Polypropylen egner seg til resirkulering



DET ER HOLDBARHETEN SOM UTGJØR FORSKJELLEN



Cambro European Logistics
Kelterstrasse 51
72669
Unterensingen
Germany

Customer Service:

General:

Phone: +49 7022 90 100 0
Fax: +49 7022 90 100 19
cambroeuropa@cambro.com

France

Tel. numero vert: 0800 91 08 78
Fax: 01 72 70 35 82
cambrofrance@cambro.com

Italia

Tel. numero verde: 800 979 141
Fax: 02 4438 6047
cambroitaly@cambro.com

Ireland

Toll free phone: 1800 509 046
Fax: 01 633 5576
cambroireland@cambro.com

UK and Northern Ireland

Toll free phone: 0800 587 0057
Fax: 0845 280 3411
cambrouk@cambro.com

Supervisor:

Lucy Murphy
direct tel. +49 7022 90 100 82
lmurphy@cambro.com

European Credit Controller:

Jan Jonkers
direct tel. +31 168 707 212
jjonkers@cambro.com