

# Montageanleitung : Standcontainer

Assembly instruction : Drawer pedestal

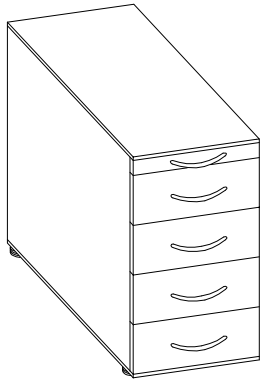

SC50



SC40

4 x A

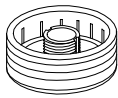

je 1 Fuss:

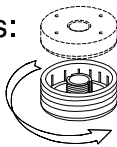

Höhe:  
72-74 cm

je 2 Fuss:

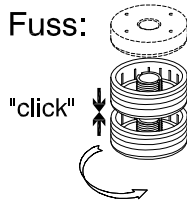

Höhe:  
74-76 cm

1

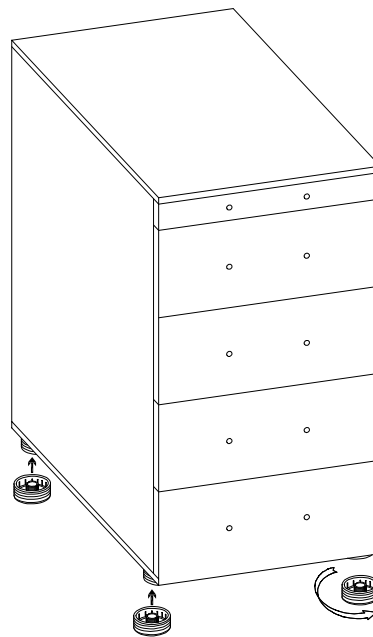

8 / 10 x C

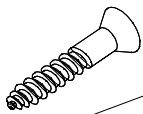

oder (or)

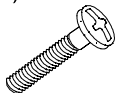

4 / 5 x D



oder (or)

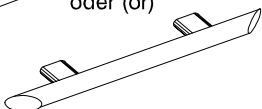

2

