

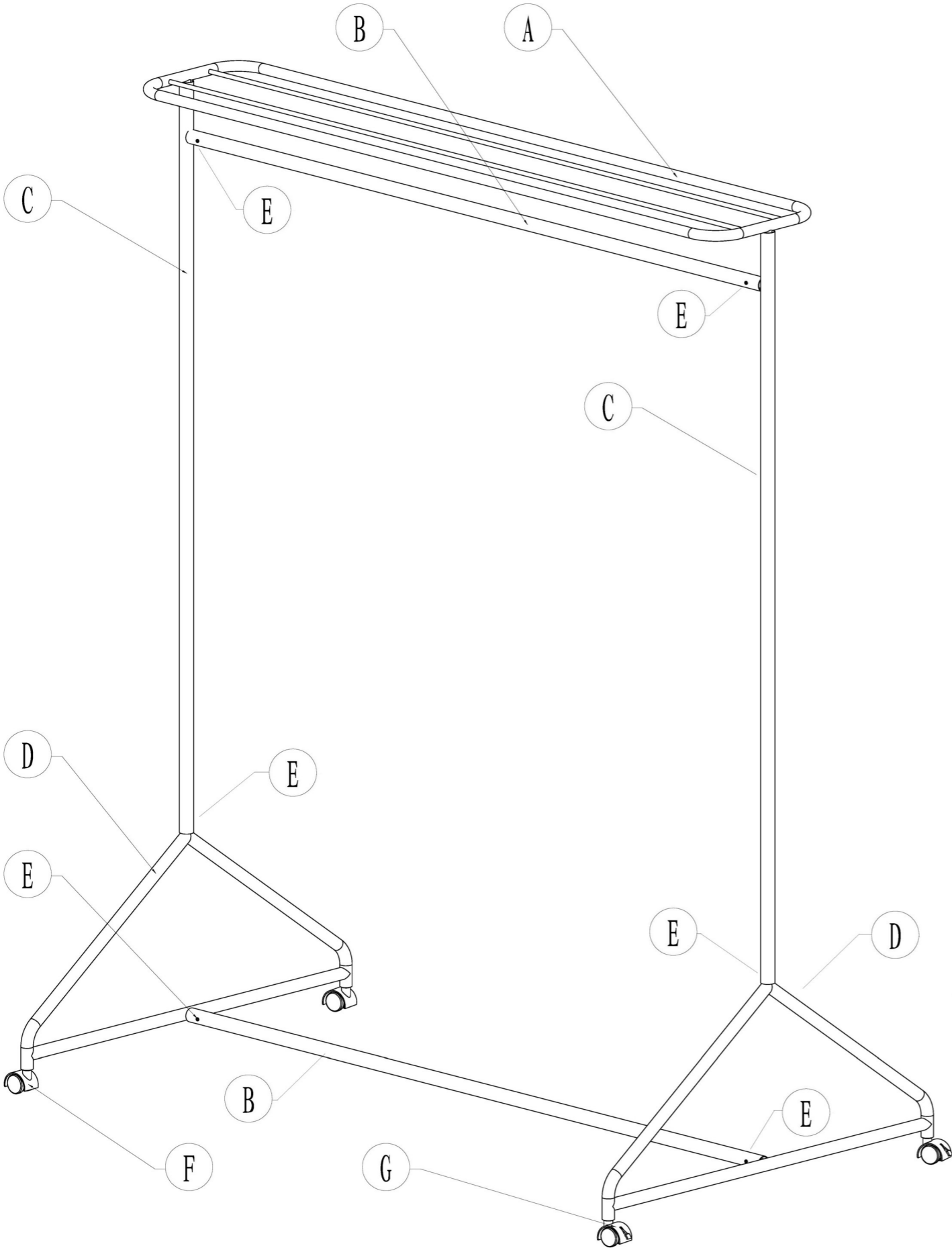





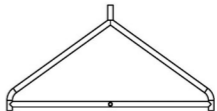

K 113 829
K 113 828

G 131 974
G 131 973



		
A*1	D*2	F*2
		
B*2		
	E*6	G*2